

Parts & Installation Instructions 16516 S.A.F. Carton

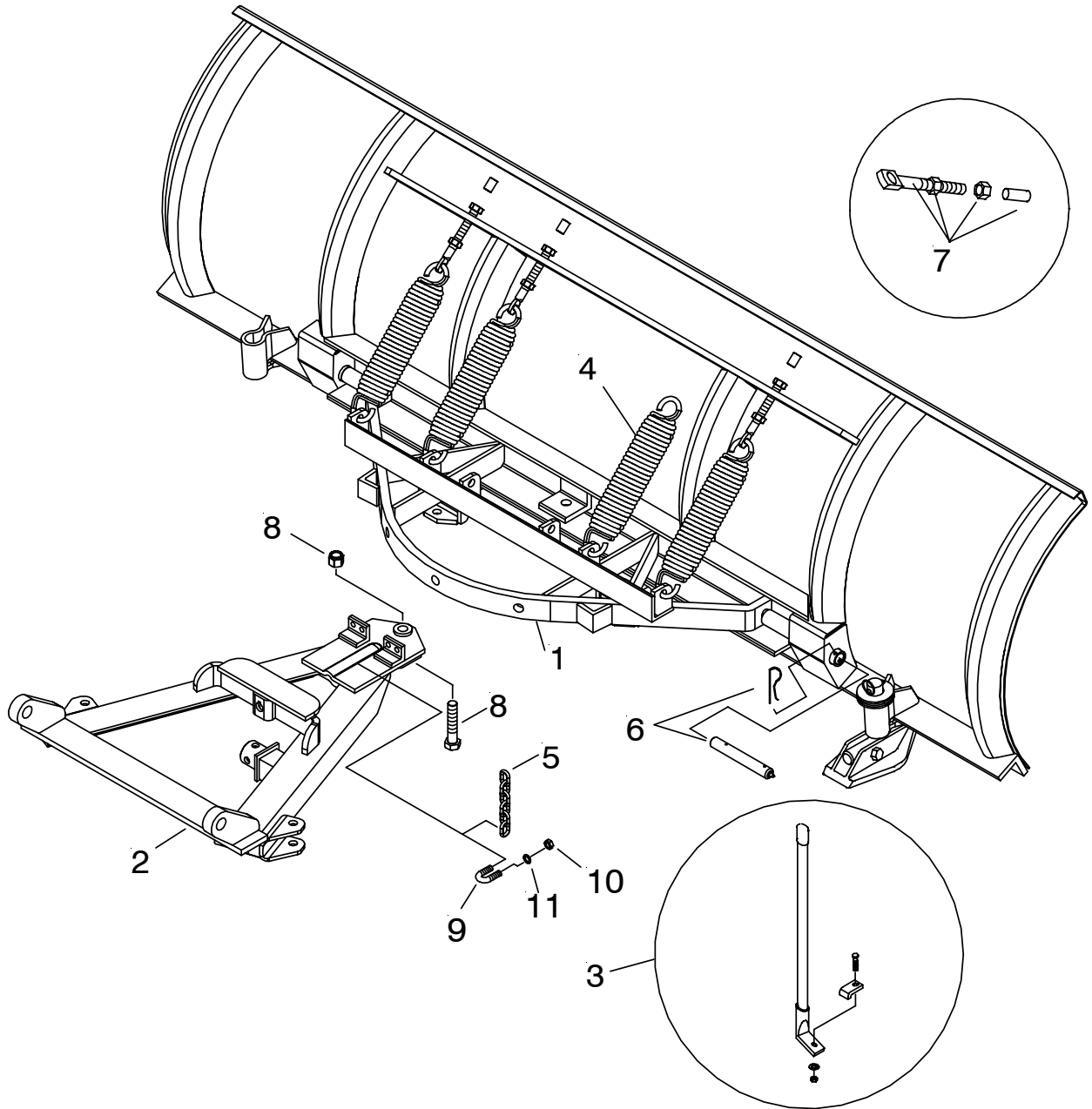

Parts List

Item	Part No.	Qty	Description
	16516	1	Sector A-Frame Carton
1	12793	1	• Sector
2	13715	1	• A-Frame (15" x 31" x 22-1/8")
3	09916	1	• Plow Marker kit
4	07017	4	• Trip Spring
5	8511002008036	2	• Lift Chain 5/16 x 36"
	08739	1	• Hardware Bag
6	09119	2	•• Pivot Pin w/ Fttg & Hair Pin
7	09124	3	•• Eye Bolt w/ Locknut & Cap
8	09125	1	•• King Bolt w/ Locknut
9	8518001026	2	•• 7/16-14 NC U-Bolt
10	8501001007	4	•• 7/16-14 NC Nut
11	20328	4	•• Lockwasher