

PARTS & INSTALLATION INSTRUCTIONS

EZ MOUNT PLUS™

SNOW PLOW MOUNTING 17175





2008 & LATER DODGE 4500/5500

& STERLING BULLET 4x4 AND 4x2 MODELS

Vehicle must be equipped with the Snow Plow Preparation Package AHD



End user must be given this instruction sheet prior to delivery of this Snow Plow.

SAFETY DEFINITIONS



	This is the safety alert symbol. It is used to alert you to potential personal injury hazards. Obey all safety messages that follow this symbol to avoid possible injury or death.
	DANGER Indicates an imminently hazardous situation which, if not avoided, will result in death or serious injury.
	WARNING Indicates a potentially hazardous situation which, if not avoided, could result in death or serious injury.
	CAUTION Indicates an potentially hazardous situation which, if not avoided, may result in minor or moderate injury.
	CAUTION used without the safety alert symbol indicates a potentially hazardous situation which, if not avoided, will result in property damage.

IMPORTANT NOTICE

In conjunction with FMVSS (Federal Motor Vehicle Safety Standards) and OEM (Original Equipment Manufacturer) guidelines, Meyer Products has designed this plow package with the following guidelines:

	Installation of a snowplow may effect your new vehicle warranty. For more information consult your Vehicle Owner's Manual / Vehicle Dealer.
	The vehicle must not be operated when overloaded. In all cases, the loaded vehicle weight, including the entire snowplow system, all aftermarket accessories, driver, passenger, options, nominal fluid levels, and cargo must not exceed the front/rear Gross Axle Weight Rating (GAWR), and total Gross Vehicle Weight Rating (GVWR). These weights ratings are specified on the safety compliance certification label on the driver's side door opening. The use of rear ballast weight may be required to prevent exceeding the front GAWR.

According to the NHTSA (National Highway Traffic Safety Administration) new and untitled vehicles need to be verified by the installer that snowplow and ballast (if needed) do no exceed the front/rear GAWR and total GVWR.

	 Read the Meyer Owner's Manual before operating or servicing a snowplow. FOLLOW THESE INSTRUCTIONS EXPLICITLY.
---	---

GENERAL INFORMATION

	SAFETY PRECAUTIONS should be used when Hydraulic Unit is in OPERATION and plow is in a RAISED position. Lower plow to ground when vehicle is PARKED in case of hydraulic failure.
---	--

Check contents against the parts list to determine all are correct and included, and also to familiarize yourself with them.

	Warranty does not apply to a Meyer or Diamond product which has been negligently or improperly assembled or installed.
---	--

	CAUTION: To avoid harm to vehicle's electrical system always disconnect battery before beginning installation. DO NOT BURN holes or WELD vehicle frame. This may cause frame failure.
---	--

OVERHAUL and SERVICE INFORMATION are covered on separate instructions.

Meyer Products LLC reserves the right, under its continuing product improvement program, to change construction or design details, specifications and prices without notice or without incurring any obligation.

PARTS LIST

ITEM	PART NO.	QTY.	DESCRIPTION
	17175	1	MOUNTING CARTON
1	19807	1	• Rear Brace Weldment
2	19493	1	• L.H. Side Member
3	19492	1	• R.H. Side Member
4	19956	2	• Handle Bolt 20"
5	19995	2	• Spacer Plate
	08209	1	• HARDWARE BAG
6	20096	8	• Bolt H 1/2-13 x 1-3/4" Gr. 5
7	20097	8	• Bolt H 1/2-13 x 2" Gr. 5
8	20141	2	• Bolt H 5/8-11 x 2" Gr. 5
9	20307	16	• Locknut ESNA 1/2-13
10	20309	2	• Locknut ESNA 5/8-11
11	20329	2	• Lockwasher 1/2"
12	20528	2	• Finish Nut 1/2-13
*	19370	1	Universal Clevis (Part of Plus CLF Carton)
**	11770	1	Universal Clevis (Part of MDII CLF Carton)



Parts indented are included in the carton, bag or assembly under which they are indented.

IMPORTANT

After first use, retighten all mounting bolt connections to specified torque. All mounting bolt connections to be checked periodically for tightness.

Locknuts are furnished DO NOT tighten bolts and nuts until installation is complete (unless otherwise specified), then be sure to tighten all attaching parts per specified torque chart.

TORQUE CHART FOOT

Bolt Nut Size	Gr. 2 	Gr. 5 	Gr. 8 
1/4 - 20	4 - 5		
5/16 - 18	9 - 11		
3/8 - 16	17 - 20	26 - 29	
7/16 - 14		42 - 46	60 - 66
1/2 - 13		64 - 72	90 - 100
5/8 - 11		127 - 141	179 - 198

NOTE:

THIS MOUNTING CARTON CAN BE USED WITH THE MDII OR EZ MOUNT PLUS CLF CARTONS.

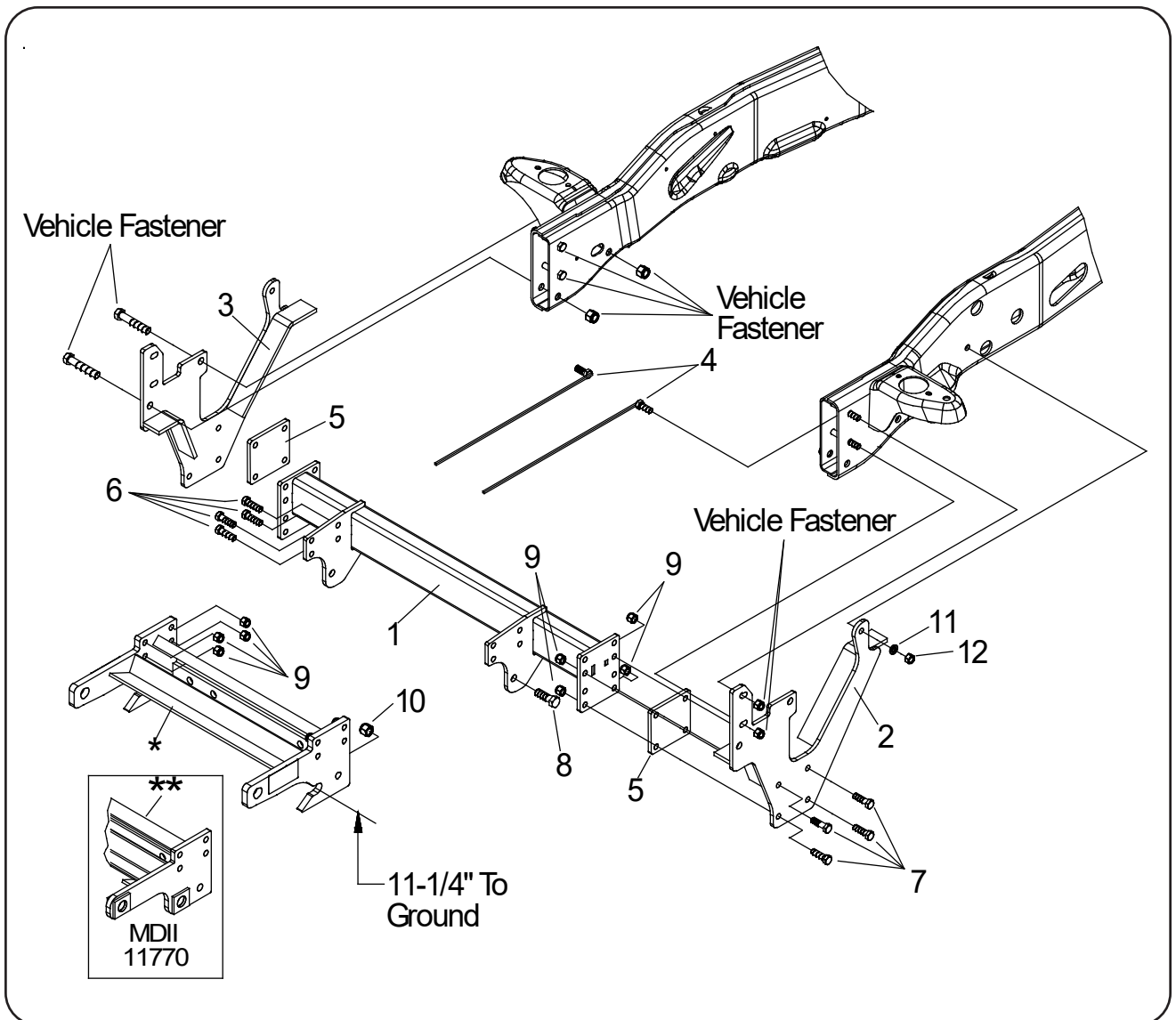

WARNING

- A ballast weight may be required to prevent front GAWR overloading. If required, ballast must be securely attached at least 24 inches behind the rear axle.

WARNING

- Front end wheel alignment and headlight aim may require readjustment after installation of equipment, and is the responsibility of the equipment installer. Failure to adjust front wheel alignment may cause premature uneven tire wear. If required, reset to chassis manufacture's specifications found in the Dodge/Sterling Shop Manual.

Rear ballast is determined by weighing a vehicle's front and rear axles and adding weight behind the rear axle until front axle weight is under or equal to the vehicle specific front GAWR while not exceeding the rear GAWR and GVWR.

Vehicle option packages may vary. If in doubt, it is always a good idea to weigh the vehicle to ensure all weight ratings are not exceeded with plow in the raised position.

NOTE ON ADDITIONAL STEPS FOR TRUCK SIDE WIRING HARNESS

On 2015 and later models, additional wiring is needed to ensure proper operation of headlights.

A wiring harness, already on the vehicle, can be found underneath the fuse box. See Figure 2.

Locate the Black/Violet wire from the harness. This wire will need to be tied to the Violet wire of the the Truck Side Harness (Part 23059).



Figure 2 - Vehicle Harness

INSTALLATION INSTRUCTIONS

- Remove tow hooks and tow hook brackets, retain all hardware if reinstallation of tow hooks is desired at a later time. Note: tow hook fasteners will be reused. Remove just the bumper bracket nuts, retain they will be reused at a later time. Note: Leave bumper bracket and bolts on truck.
- Position LH Side Member and RH Side Member (2 & 3) to outside of vehicle frame. Align and attach bottom (5/8) holes using tow hook hardware. Attach front two holes using bumper bracket nuts. Attach rear holes using Handle Bolt (4), 1/2" Lockwasher (11) and 1/2-13 Finish Nut (12).
- Attach LH and RH Side Members (2 & 3) and Spacer Plates (5) to Rear Brace Assembly (1) using 1/2-13 X 2" Bolt (7) and 1/2-13 Locknut (9).
- Attach Rear Brace Assembly (1) to Universal Clevis (*) using 1/2-13 X 1-3/4" Bolt (6) and 1/2-13 Locknut (9) in the 4 upper holes. Also attach using 5/8-11 x 2" Bolt (8) and 5/8-11 Locknut (10) in the lower holes.

Note: before tightening the fasteners, the clevis should be level with the ground and pushed back as far under the vehicle as possible.
- Tighten bolts to the torque specified in the chart below. Tighten in the same order in which they were assembled to the vehicle.
- Install remaining snowplow hardware per separate instructions.

Meyer Products LLC assumes no responsibility for installations not made in accordance with these instructions.