





**PARTS & INSTALLATION INSTRUCTIONS**  
**MDII™ and EZ MOUNT PLUS™**  
**SNOW PLOW MOUNTING 17173**  
**2003 & LATER T300 DODGE**  
**W2500, W3500 & POWERWAGON 4x4 MODELS**  
**Vehicle must be equipped with the Snow Plow Preparation Package AHD**



End user must be given this instruction sheet prior to delievery of this Snow Plow.

**SAFETY DEFINITIONS**



	This is the safety alert symbol. It is used to alert you to potential personal injury hazards. Obey all safety messages that follow this symbol to avoid possible injury or death.
	<b>DANGER</b> Indicates an imminently hazardous situation which, if not avoided, will result in death or serious injury.
	<b>WARNING</b> Indicates a potentially hazardous situation which, if not avoided, could result in death or serious injury.
	<b>CAUTION</b> Indicates an potentially hazardous situation which, if not avoided, may result in minor or moderate injury.
	<b>CAUTION</b> used without the safety alert symbol indicates a potentially hazardous situation which, if not avoided, will result in property damage.

**IMPORTANT NOTICE**

In conjunction with FMVSS (Federal Motor Vehicle Safety Standards) and OEM (Original Equipment Manufacturer) guidelines, Meyer Products has designed this plow package with the following guidelines:

	Installation of a snowplow may effect your new vehicle warranty. For more information consult your Vehicle Owner's Manual / Vehicle Dealer.
	The vehicle must not be operated when overloaded. In all cases, the loaded vehicle weight, including the entire snowplow system, all aftermarket accessories, driver, passenger, options, nominal fluid levels, and cargo must not exceed the front/rear Gross Axle Weight Rating (GAWR), and total Gross Vehicle Weight Rating (GVWR). These weights ratings are specified on the safety compliance certification label on the driver's side door opening. The use of rear ballast weight may be required to prevent exceeding the front GAWR.

According to the NHTSA (National Highway Traffic Safety Administration) new and untitled vehicles need to be verified by the installer that snowplow and ballast (if needed) do no exceed the front/rear GAWR and total GVWR.

	 Read the Meyer Owner's Manual before operating or servicing a snowplow. <b>FOLLOW THESE INSTRUCTIONS EXPLICITLY.</b>
---	--

**GENERAL INFORMATION**

	<b>SAFETY PRECAUTIONS</b> should be used when <b>Hydraulic Unit is in OPERATION</b> and plow is in a <b>RAISED</b> position. <b>Lower plow to ground when vehicle is PARKED in case of hydraulic failure.</b>
---	---

Check contents against the parts list to determine all are correct and included, and also to familiarize yourself with them.

	Warranty does not apply to a Meyer or Diamond product which has been negligently or improperly assembled or installed.
---	--

	<b>CAUTION: To avoid harm to vehicleelectrical system always</b> disconnect battery before beginning installation. <b>DO NOT BURN</b> holes or <b>WELD</b> vehicle frame. This may cause frame failure.
---	---

**OVERHAUL and SERVICE INFORMATION** are covered on separate instructions.

Meyer Products reserves the right, under its continuing product improvement program, to change construction or design details, specifications and prices without notice or without incurring any obligation.

Meyer Products LLC  
18513 Euclid Ave. • Cleveland, Ohio 44112-1084  
Phone 486-1313 (Area Code 216)  
www.meyerproducts.com • email info@meyerproducts.com



Meyer Products LLC  
6 Angell Lane • Damariscotta, ME 04543-4507  
Phone 563-2227 (Area Code 207)  
www.meyerproducts.com • email info@meyerproducts.com

## PARTS LIST

ITEM	PART NO.	QTY.	DESCRIPTION
	17173	1	<b>MOUNTING CARTON</b>
1	11848	1	• Rear Brace Weldment
2	19327	1	• L.H. Hanger Weldment
3	19326	1	• R.H. Hanger Weldment
4	19091	1	• L.H. Side Member
5	19090	1	• R.H. Side Member
	08794	1	• <b>HARDWARE BAG</b>
6	14595	4	•• Special Bolt 3/4"
7	19085	2	•• Sleeve
8	20096	8	•• Bolt H 1/2-13 x 1-3/4" Gr. 5
9	20105	6	•• Bolt H 1/2-13 x 4" Gr. 5
10	20141	6	•• Bolt H 5/8-11 x 2" Gr. 5
11	20165	4	•• Bolt H 3/4-10 x 2-1/4" Gr. 5
12	20307	14	•• Locknut ESNA 1/2-13
13	20309	6	•• Locknut ESNA 5/8-11
14	20310	8	•• Locknut ESNA 3/4-10
15	20355	12	•• Flatwasher 1/2"
16	20357	4	•• Flatwasher 5/8"
17	20359	12	•• Flatwasher 3/4"
*	19370	1	<b>Universal Clevis (Part of Plus CLF Carton)</b>
**	11770	1	<b>Universal Clevis (Part of MDII CLF Carton)</b>
<b>11" Sector</b>		<b>15" Sector</b>	
<b>PART NO.</b>	<b>PART NO.</b>	<b>QTY.</b>	<b>MEYER DESCRIPTION</b>
16515	16516	1	<b>Sector A-Frame Carton</b>
<b>DIAMOND</b>			
81504		1	<b>Common Attaching Kit</b>
81026		1	<b>Push Frame</b>

Parts indented are included in the carton, bag or assembly under which they are indented.

## IMPORTANT

After first use, retighten all mounting bolt connections to specified torque. All mounting bolt connections to be checked periodically for tightness.

Locknuts are furnished **DO NOT** tighten bolts and nuts until installation is complete (unless otherwise specified), then be sure to tighten all attaching parts per specified torque chart.

## TORQUE CHART FOOT

Bolt Nut Size	Gr. 2	Gr. 5	Gr. 8
1/4 - 20	4 - 5		
5/16 - 18	9 - 11		
3/8 - 16	17 - 20	26 - 29	
7/16 - 14		42 - 46	60 - 66
1/2 - 13		64 - 72	90 - 100
5/8 - 11		127 - 141	179 - 198

### NOTE:

THIS MOUNTING CARTON CAN BE USED WITH THE MDII OR EZ MOUNT PLUS CLF CARTONS.

Meyer Products assumes no responsibility for installations not made in accordance with these instructions.

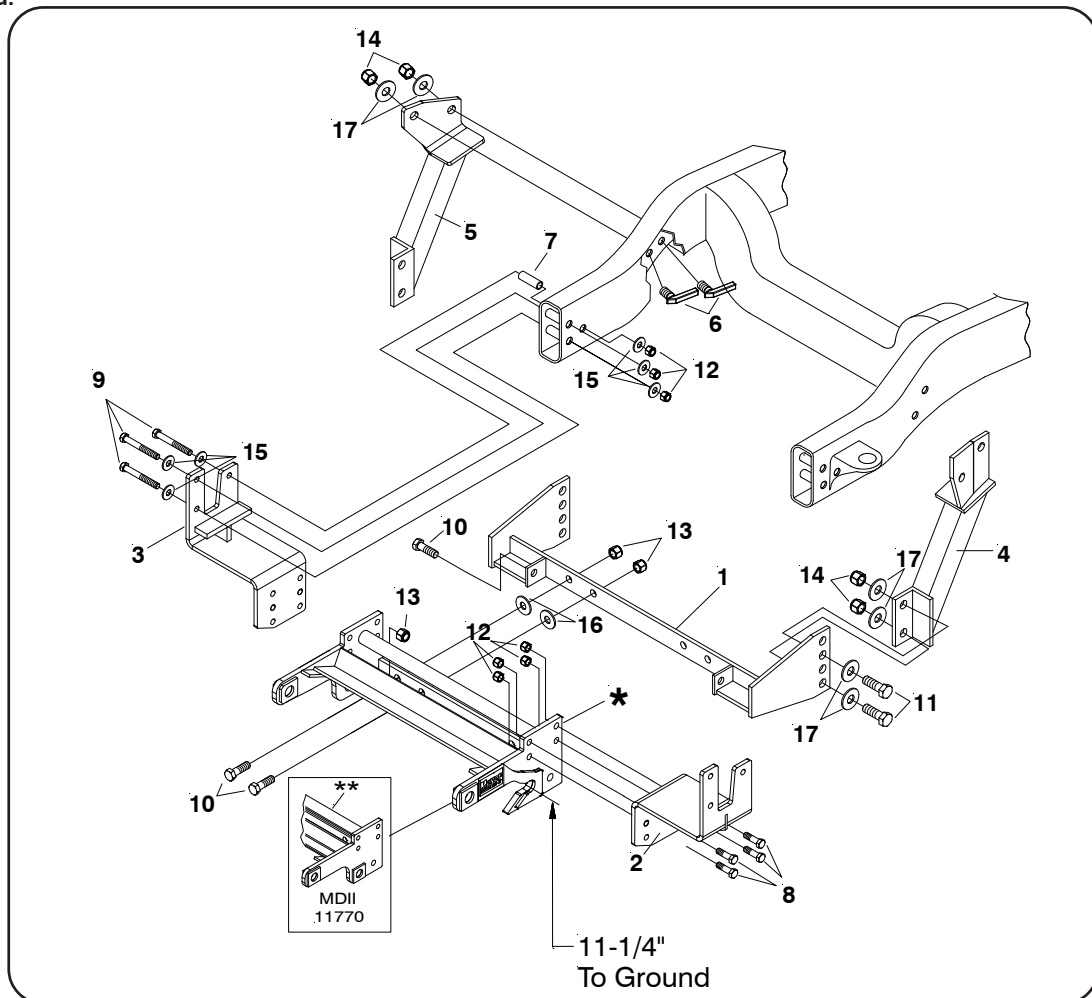

**⚠ WARNING**

- A ballast weight may be required to prevent front GAWR overloading. If required, ballast must be securely attached at least 24 inches behind the rear axle.

**⚠ WARNING**

- Front end wheel alignment and headlight aim may require readjustment after installation of equipment, and is the responsibility of the equipment installer. Failure to adjust front wheel alignment may cause premature uneven tire wear. If required, reset to chassis manufacturer's specifications found in the Dodge Shop Manual.

Rear ballast is determined by weighing a vehicle's front and rear axles and adding weight behind the rear axle until front axle weight is under or equal to the vehicle specific front GAWR while not exceeding the rear GAWR and GVWR.

Vehicle option packages may vary. If in doubt, it is always a good idea to weigh the vehicle to ensure all weight ratings are not exceeded with plow in the raised position.

## INSTALLATION INSTRUCTIONS

- A. Remove bumper/tow hooks assembly from vehicle frame by removing the front two bolts through the frame. Retain all hardware They will not be reused. 2010 & newer vehicles may be equipped with a blocker beam and brackets which will need to be removed. Retain for re-installation if the mounting is removed from the vehicle.
- B. Attach Hanger Weldments (2&3) to vehicle frame at bumper support holes using 1/2-13 x 4" bolts (9), flatwashers (15) and locknuts (12). While pushing clevis tight against the bottom of the frame, snug bolts. Using the rear hole of each hanger weldment as a template, drill a 9/16" hole all the way through the frame on both sides. Remove the hanger weldments.
- C. On the outside of each frame rail only, re-drill the hole to 3/4" diameter to install the sleeves (7). Reinstall the rear holes of the hanger weldments to frame using sleeves (7), 1/2-13 x 4" bolts (9), 1/2 flatwashers (15), and locknuts (12). Reinstall the bumper in the two front holes on each hanger using the bolts from step B. **Note: Vehicles with tow hooks: Outer tow hook bracket may need to be removed and slotted behind the bumper to allow for fit over side plates of hanger weldments or tow hooks may be removed completely.**



- D. Attach Universal Clevis (\*) between Hanger Weldments (2&3) using four 1/2-13 x 1 3/4" bolts (8), and 1/2-13 locknuts (12) on each side. **Lower holes on Hanger Weldments (2 & 3) may need to be used due to vehicle configuration. Note: Bumper may need to be notched around front lobes of Universal Clevis (\*).**

**IMPORTANT:** Torque all 1/2-13 x 4" bolts (9) while holding Hanger Weldments (2&3) against the bottom of the frame and torque all 1/2-13 x 1 3/4" bolts (8) while holding the bottom of Universal Clevis Frame(\*) parallel to the ground per torque specification chart.

- E. Attach Rear Brace Weldment (1) to the rear of the Universal Clevis (\*) using six 5/8-11 x 2" bolts (10) and locknuts (13) per illustration. **Note: 5/8 Flatwashers (16) should be sandwiched the between the Universal Clevis (\*) and the Rear Brace Weldment (1) on the four rear holes. It may be necessary to trim Rear Brace Weldment (1) at 4th hole from bottom.**
- F. Attach the LH & RH Side Members (4&5) to the hole closest to the ground and the third one up on the Rear Brace Weldment (1) using 3/4-10 x 2-1/4" bolts (11), flatwashers (17), and locknuts (14). While pushing sidemembers (4&5) up against the frame snug bolts. Scribe sidemember's (4&5) hole locations on the frame on both sides. Remove sidemembers (4&5). Drill 1" diameter holes through the out side of the each frame rail only for installation of Special bolts (6).
- G. Carefully attach side members (4&5) to frame using special bolts (6), flatwashers (17) and locknuts (14) per illustration. Reattach side members to rear brace weldment using hardware from step F.
- H. Tighten bolts to the torque specified in the chart below. Tighten in the same order in which they were assembled to the vehicle.
- I. Install remaining snowplow hardware per separate instructions.