

V-70 power unit service manual



Meyer Products LLC
18513 Euclid Ave. • Cleveland, Ohio 44112-1084
Phone 486-1313 (Area Code 216)
www.meyerproducts.com • email info@meyerproducts.com

FOREWARD

This Service Manual includes complete information for servicing the following Electro Lift® Units:

V-70 Super V Hydraulic Unit

IMPORTANT: Maintenance and repairs must be performed with the moldboard on the ground.

The information is grouped according to the type of work being performed, such as diagnosis and testing, disassembly and reassembly. Special tools and specifications are also included in this manual.

All information, illustrations and product descriptions contained in this manual are correct at publication time. We do, however, reserve the right to make changes at any time without prior notice.

MEYER PRODUCTS INC.

SECTION INDEX

Section Number	Section Title	Page
0	GENERAL INFORMATION AND MAINTENANCE	1
1	GENERAL DESCRIPTION AND THEORY OF OPERATION	5
2	DIAGNOSIS	18
3	REPAIR PROCEDURE	36
4	SPECIFICATIONS	60

SECTION 0 - GENERAL INFORMATION AND MAINTENANCE

CONTENTS

- GENERAL INFORMATION 2
 - MODEL IDENTIFICATION 2
 - MODEL IDENTIFICATION AND SERIAL NUMBER LOCATION 2
- MAINTENANCE 2
 - GENERAL MAINTENANCE 2
 - CLEANLINESS 2
 - VEHICLE ELECTRICAL SYSTEM 2
 - CHECK REGULARLY 2
- POST-SEASON MAINTENANCE 2
 - MEYER HYDRAULIC FLUID M-1 2
 - REPLACEMENT OF HYDRAULIC FLUID 2
 - PROTECTION AGAINST RUST AND CORROSION 3

GENERAL INFORMATION

Model Identification

The V-70 unit is an electrically powered hydraulic mechanism specifically designed for use with the Meyer E-Z Mount Plus Super-V Snow Plow system.

Model Identification and Serial Number Location

Inclusion of the model number and serial number is extremely important when writing up warranty claim forms and product report forms for proper evaluation and follow up.

The basic model number is located on the name plate (plastic cover). The serial number is located on the name plate decal underneath the plastic cover.



MAINTENANCE

The following maintenance information is intended as a basic guide for providing the V-70 unit with the proper service and care. Sustained heavy duty operation or operating under adverse conditions may necessitate more frequent servicing.

General Maintenance

Cleanliness

The greatest enemy to any hydraulic system is dirt or contamination. Therefore, cleanliness must be stressed at the time of installation, servicing and repairing.

Vehicle Electrical System

Maximum performance and efficiency of the Electro Lift® unit requires that the vehicle's electrical system be properly maintained and consist of:

Battery -----	70 Amp. Hr. Minimum or 550 Cold Cranking Amps.
Alternator -----	60 Amp. Minimum

Check Regularly

1. Battery Terminals - Must be clean and free of corrosion.
2. Electrical Connections - Must be free of corrosion and tight.
3. Battery - Must be in first-class condition.
4. Alternator (or Generator) and Regulator - Must be functioning to specifications.
5. Hydraulic Fluid Reservoir Level - A significant drop in hydraulic fluid level indicates a leak which must be located and corrected. Insufficient hydraulic fluid may result in severe damage.

POST-SEASON MAINTENANCE

Meyer Hydraulic Fluid M-1.

Meyer Hydraulic Fluid M-1 is a specially formulated mineral oil which maintains an almost constant viscosity from normal to sub-zero temperatures. Because it remains free flowing at extremely low temperatures, the performance and efficiency are not affected.

Meyer Hydraulic Fluid M-1 also contains an additive which neutralizes moisture accumulating in the fluid due to condensation. It is effective for a maximum of one year's use.

Meyer Products Inc. will not be liable for damages resulting from the use of inferior or other fluids or oils.

FIGURE 0-1 V-70

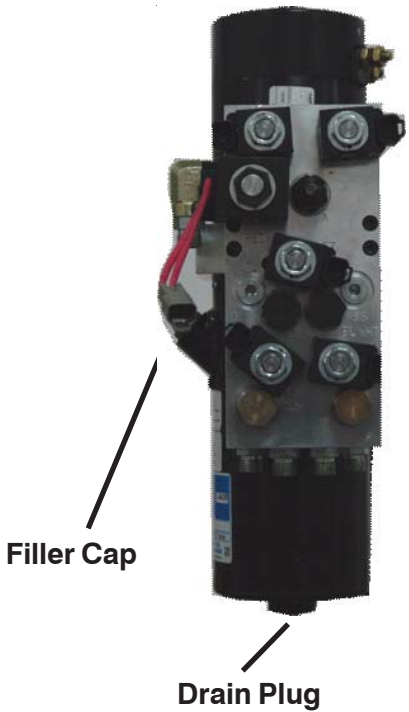

Replacement of Hydraulic Fluid

After a season's use, completely drain the hydraulic fluid (including hydraulic fluid in hoses and cylinders). Drain fluid through filler hole shown in Figure 0-1 or drain hole in base by completely retracting lift rod and unbolting unit to pour fluid out or using a suction pump. Disconnect the fittings at the Angling cylinders and completely retract the cylinder rods and purge cylinders and hoses of all hydraulic fluid. Flush the complete system including unit, hoses and angling rams with the M-2 Flushing Fluid, or a non wax (Naphthenic) cleaner. If kerosene (Parrafinic) is used to flush the system, the system must be flushed again to remove any kerosene with M-2 Flushing Fluid, or a (Naphthenic) based cleaner that is wax free .

Refill V-70 unit with M-1 Fluid by fully retracting lift rod (Ram) and filling reservoir to just below the filler neck. Fill and bleed hoses and Power Angling cylinders by loosening hydraulic fittings at cylinders until they leak. Power angle wings repeatedly from one side to the other until fluid flows steadily from the leaking fittings while maintaining a constant check on the reservoir fluid level.

Raise and lower the plow several times and with lift rod fully retracted, give a final check to the fluid level and replace filler plug. Proper fluid level is achieved when the plow can be fully raised and both plow wings are extended into the Scoop position.

Protection Against Rust and Corrosion

When the V-70 unit is not used for extended periods, protect the chromed lift rod (Ram) by fully extending it and coating it with chassis lubricant. Full extension of the lift rod (Ram) fills the cylinder with hydraulic fluid. Also put the plow wings in the retracted position so the Angle cylinders do not expose the chrome rod.



M-2 Flush Fluid



M-1 Hydraulic Fluid

SECTION 1 - GENERAL DESCRIPTION AND THEORY OF OPERATION

CONTENTS

GENERAL DESCRIPTION	5
THEORY OF OPERATION	5
• FUNCTIONS	5
• ELECTRICAL AND FLOW CHARTS	6-15
ELECTRO LIFT® UNIT COMPONENTS	16
• MOTOR	16
• HYDRAULIC PUMP	16
• PRESSURE RELIEF VALVE	16
• SOLENOID VALVES	16-17
•• Cartridge	16
•• Coil	17
• CHECK VALVES	17
• PILOT CHECK VALVE	17
• CROSSOVER RELIEF VALVES	17
• SOLENOID SWITCH	17
• FILTERS	17

GENERAL DESCRIPTION

V-70 unit is an electrically powered and electrically controlled hydraulic mechanism specifically designed for use with Meyer Super-V Snow Plows. The V-70 raises and lowers the plow with an integral 8" stroke hydraulic cylinder.

In addition to raising and lowering the plow hydraulically, the V-70 angles the plow wings hydraulically, left and right, via remote double acting hydraulic cylinders.

The Electro Lift® unit consists of a specially designed high torque 12-volt DC motor which is directly coupled to a gear-type hydraulic pump. The pump obtains its supply of hydraulic fluid from an integral reservoir which totally surrounds the integral hydraulic cylinder which raises and lowers the plow.

The V-70 includes an integral valve body which contains six electrically controlled solenoid valve cartridges. Solenoid valve cartridge "S1", "S2", "S3", "S5", "S6" and "S7".

Additional components which control and supply electrical current to the V-70 unit is an operator controlled Touchpad, a solenoid switch to supply high amperage current to the unit's motor (motor solenoid)

THEORY OF OPERATION

FUNCTIONS

The V-70's eight basic functions performed are:

- Raise snow plow
- Lower snow plow
- Extend Left Wing
- Retract Left Wing
- Extend Right Wing
- Retract Right Wing
- Angle Left
- Angle Right

Refer to Figures 1-1 through 1-10 (pages 6 thru 15) for electrical and hydraulic flow chart for each function. Each figure explains which component is actuated and related in each function.

V-70 Raise: Motor, "S1" and "S2"

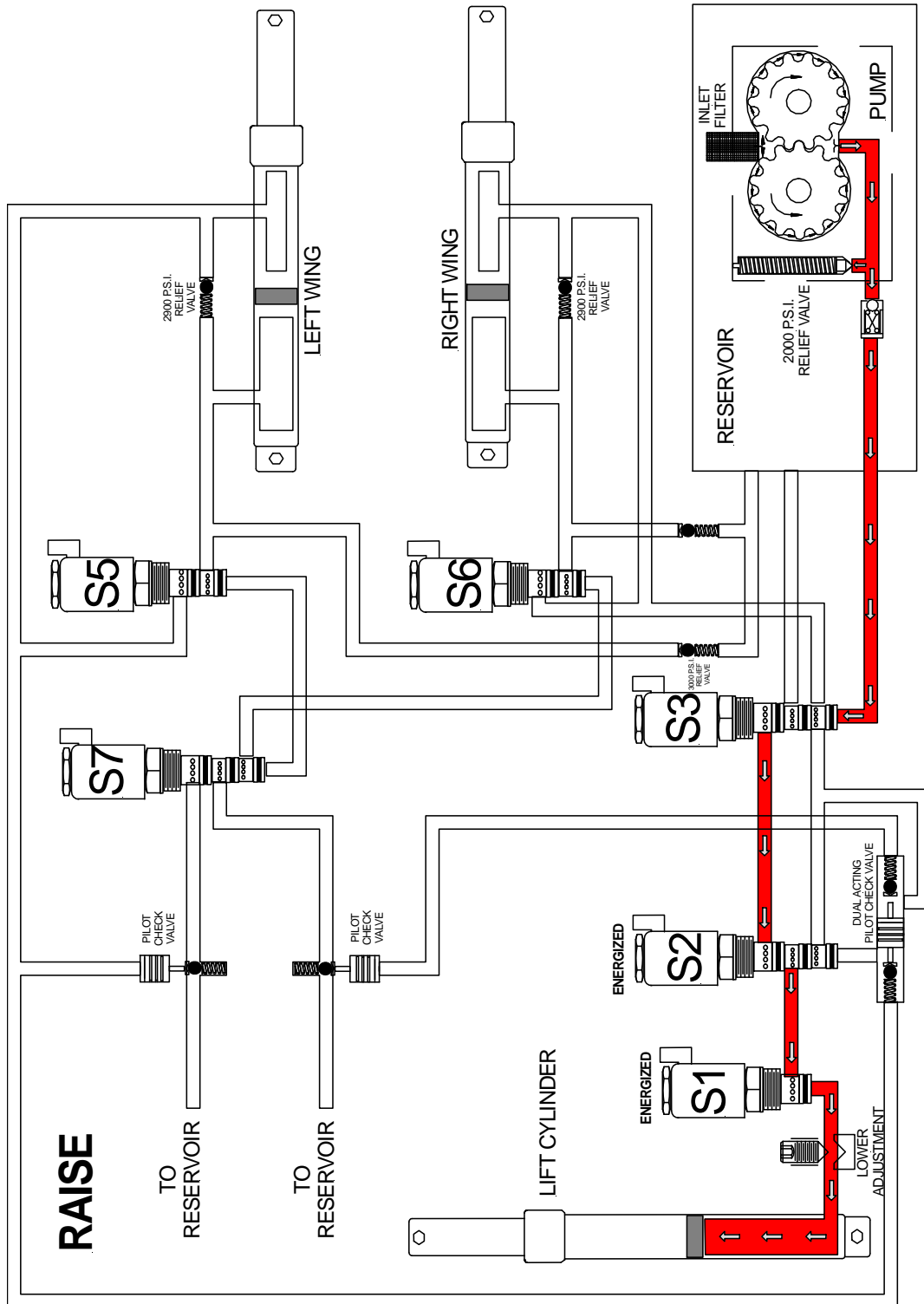

FIGURE 1-1

V-70 Lower: "S1", "S2" and "S3"

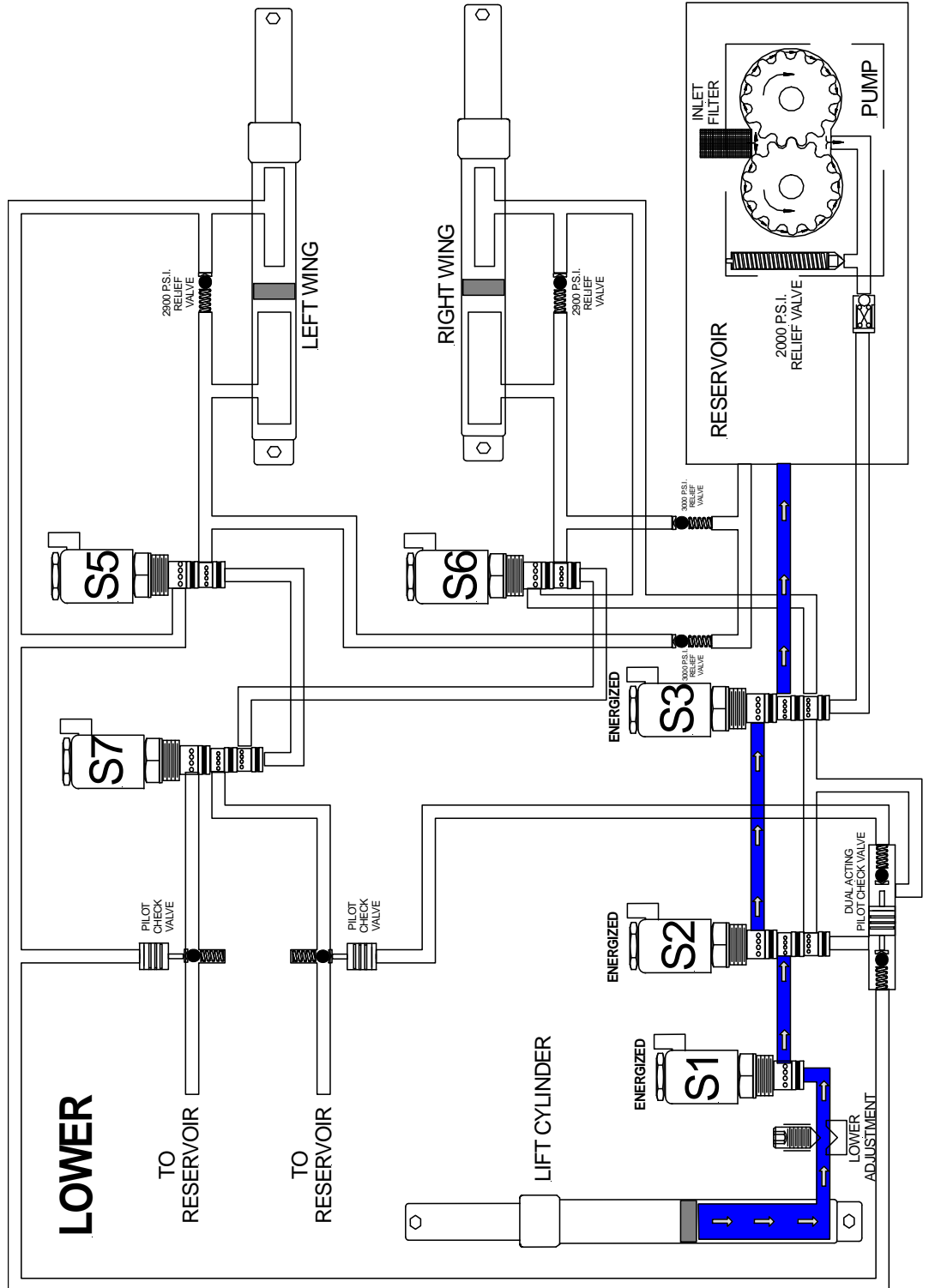

FIGURE 1-2

V-70 Angle Left: Motor Only

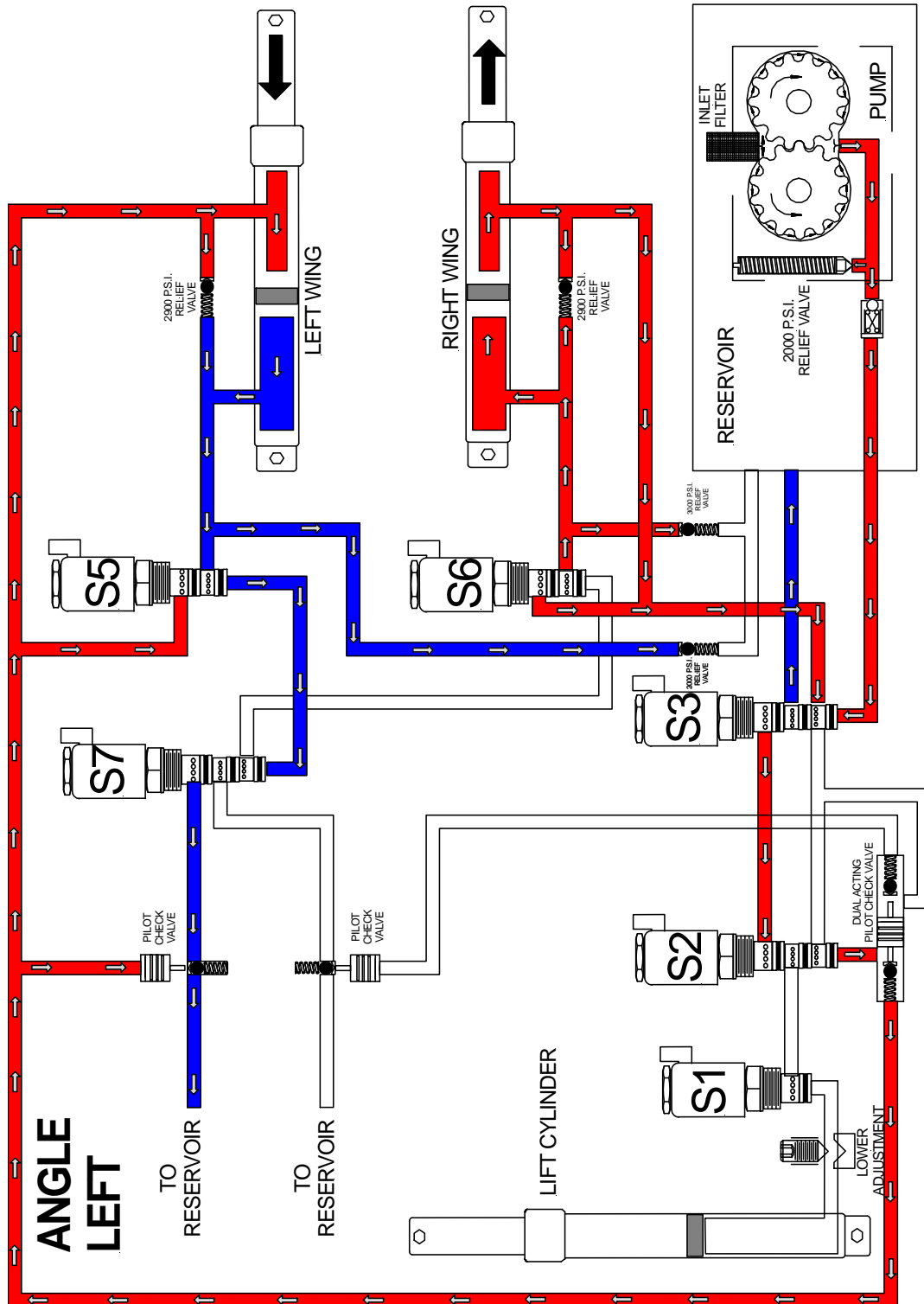

FIGURE 1-3

V-70 Angle Right: Motor and "S3"

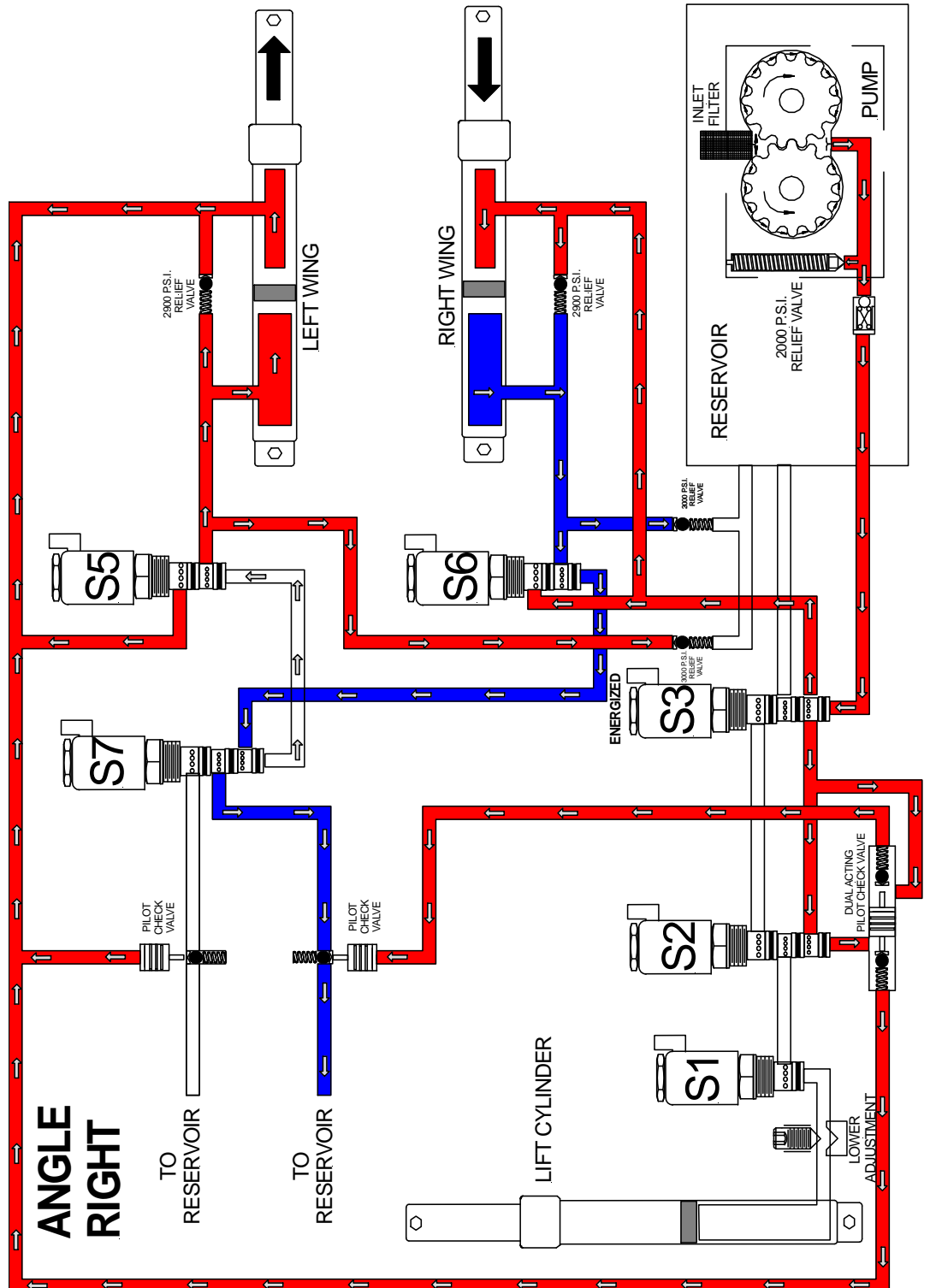

FIGURE 1-4

V-70 Left Extend: Motor and "S5"

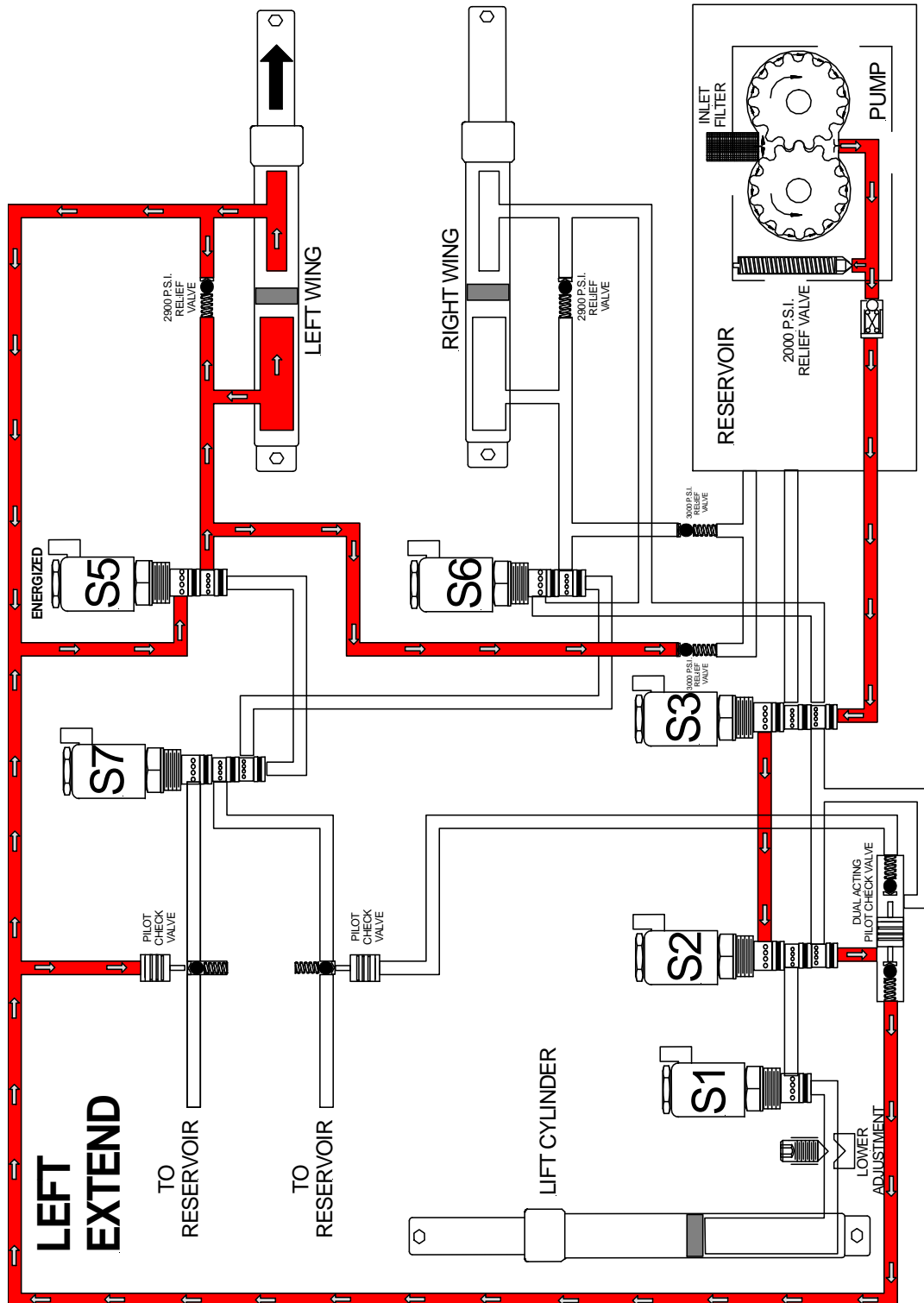

FIGURE 1-5

V-70 Left Retract: Motor and "S7"

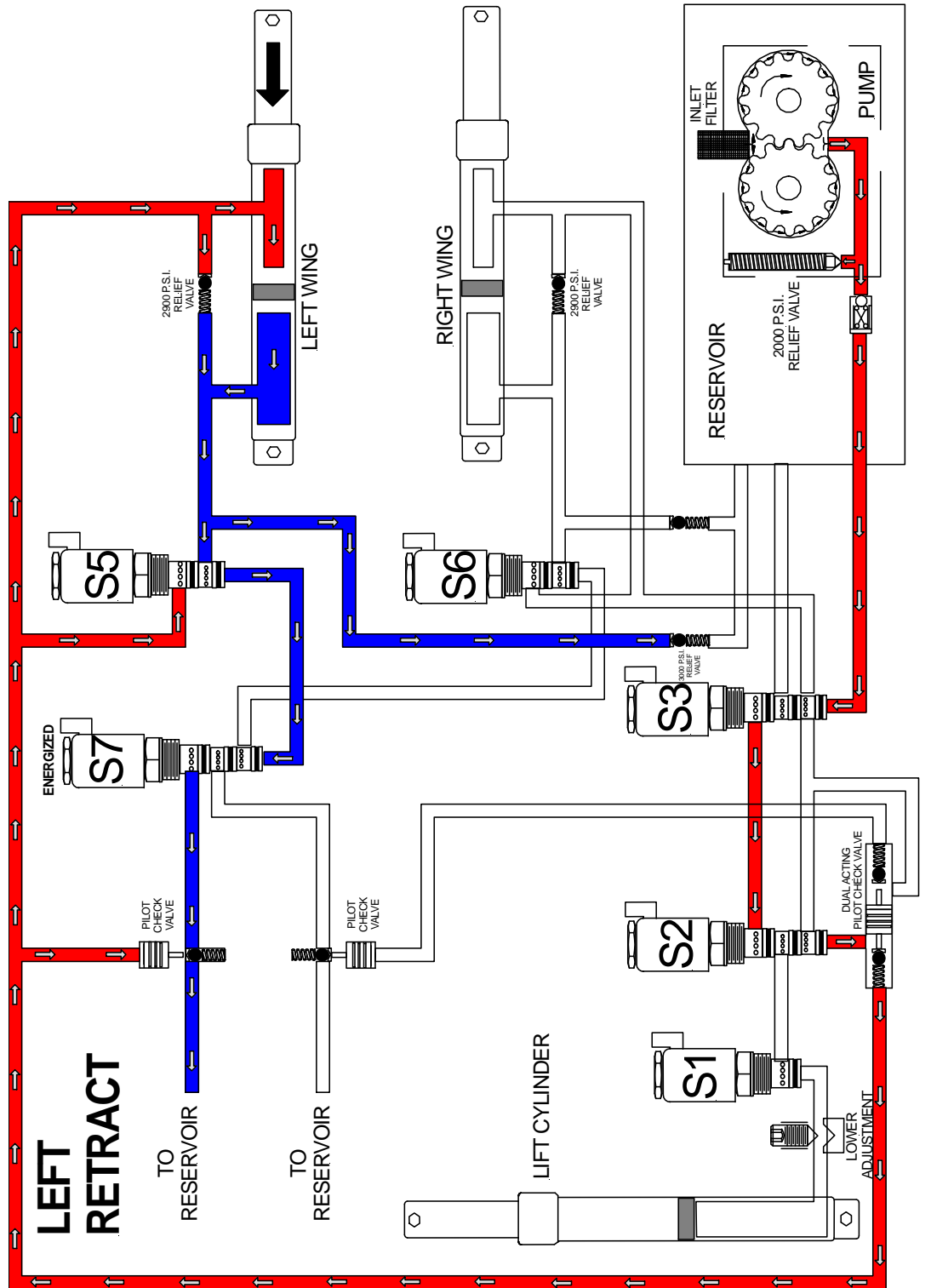

FIGURE 1-6

V-70 Right Extend: Motor, "S3" and "S6"

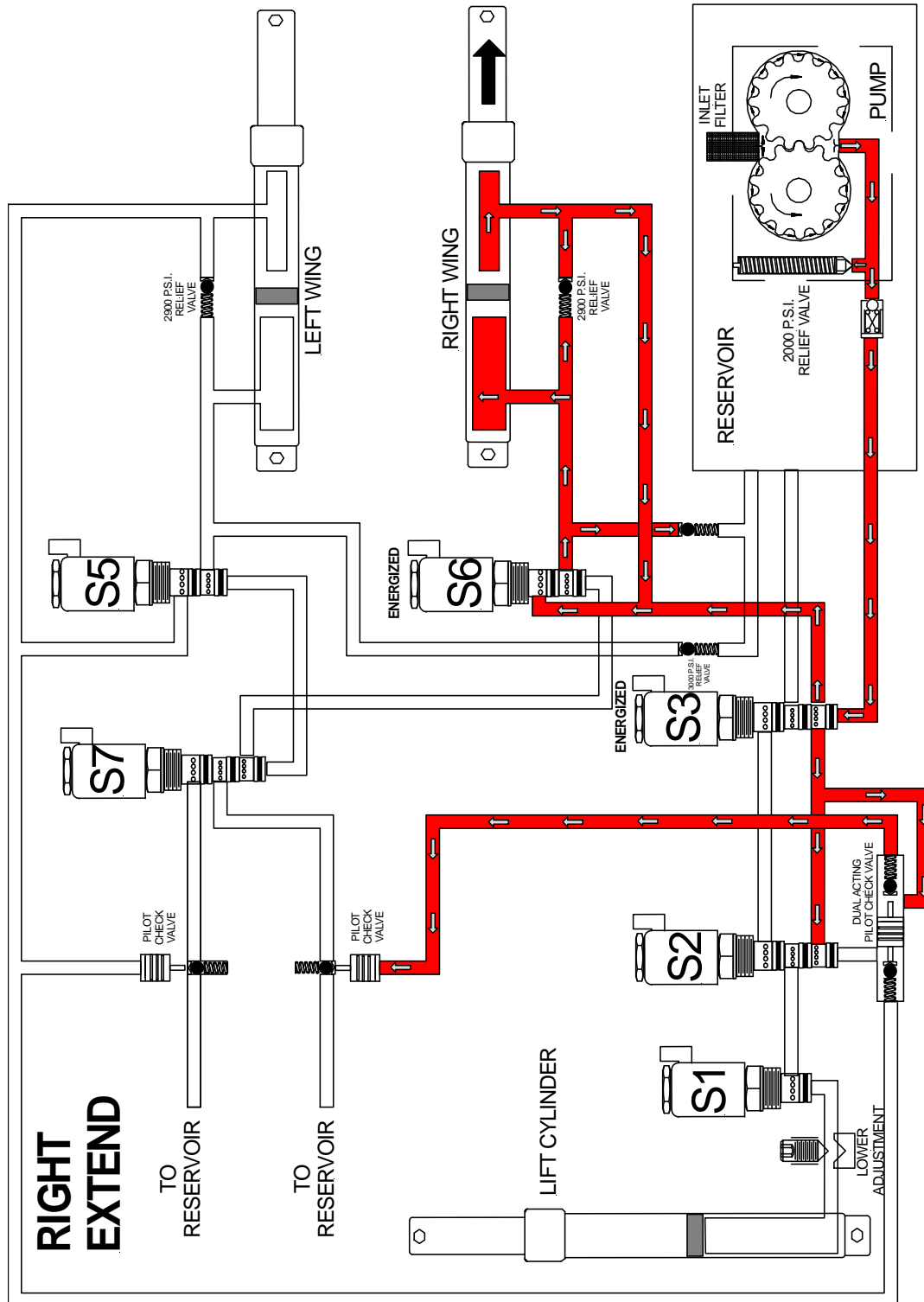

FIGURE 1-7

V-70 Right Retract: Motor, "S3" and "S7"

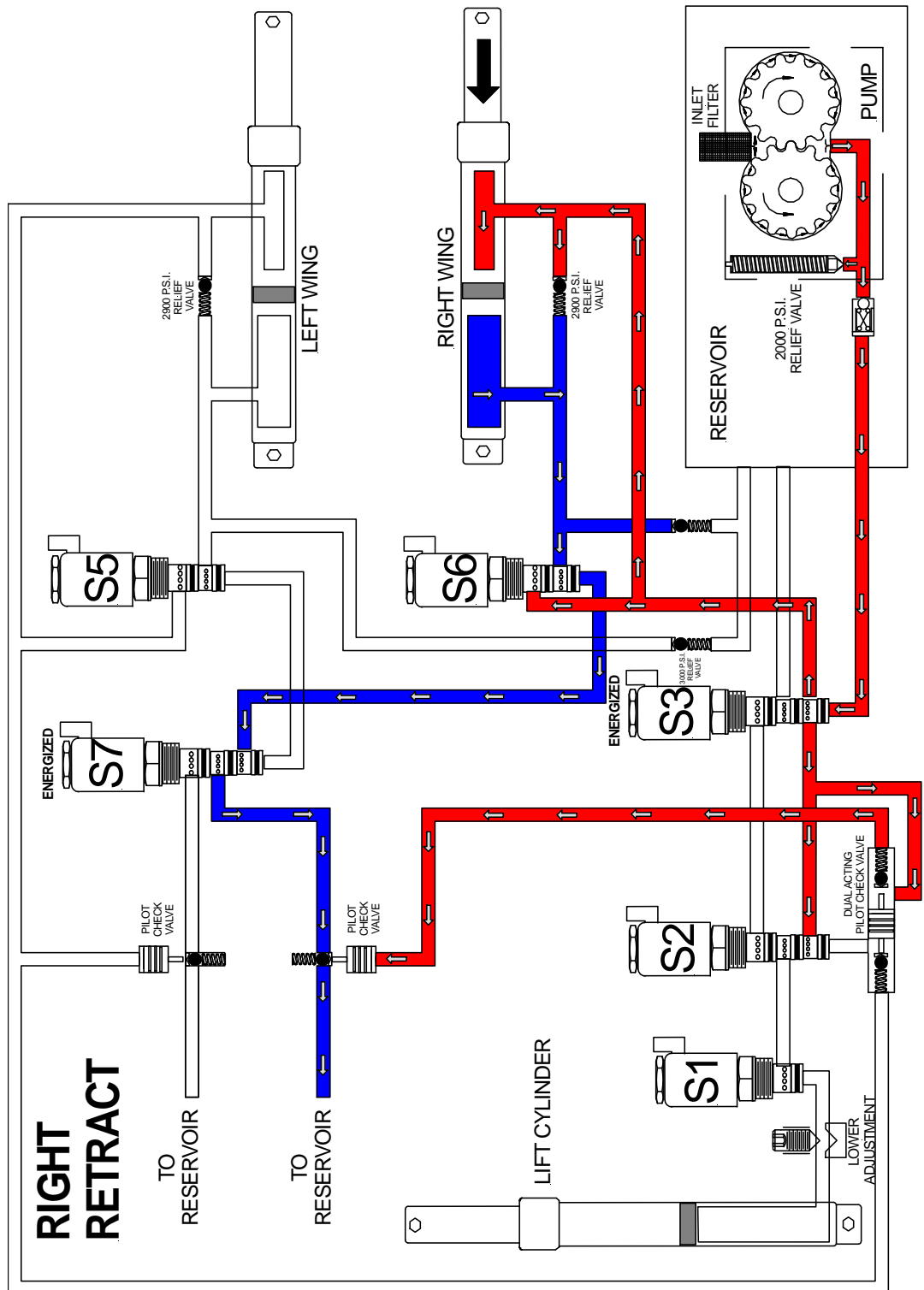

FIGURE 1-8

V-70 Scoop: Motor, "S2", "S3", "S5", "S6" and "S7"

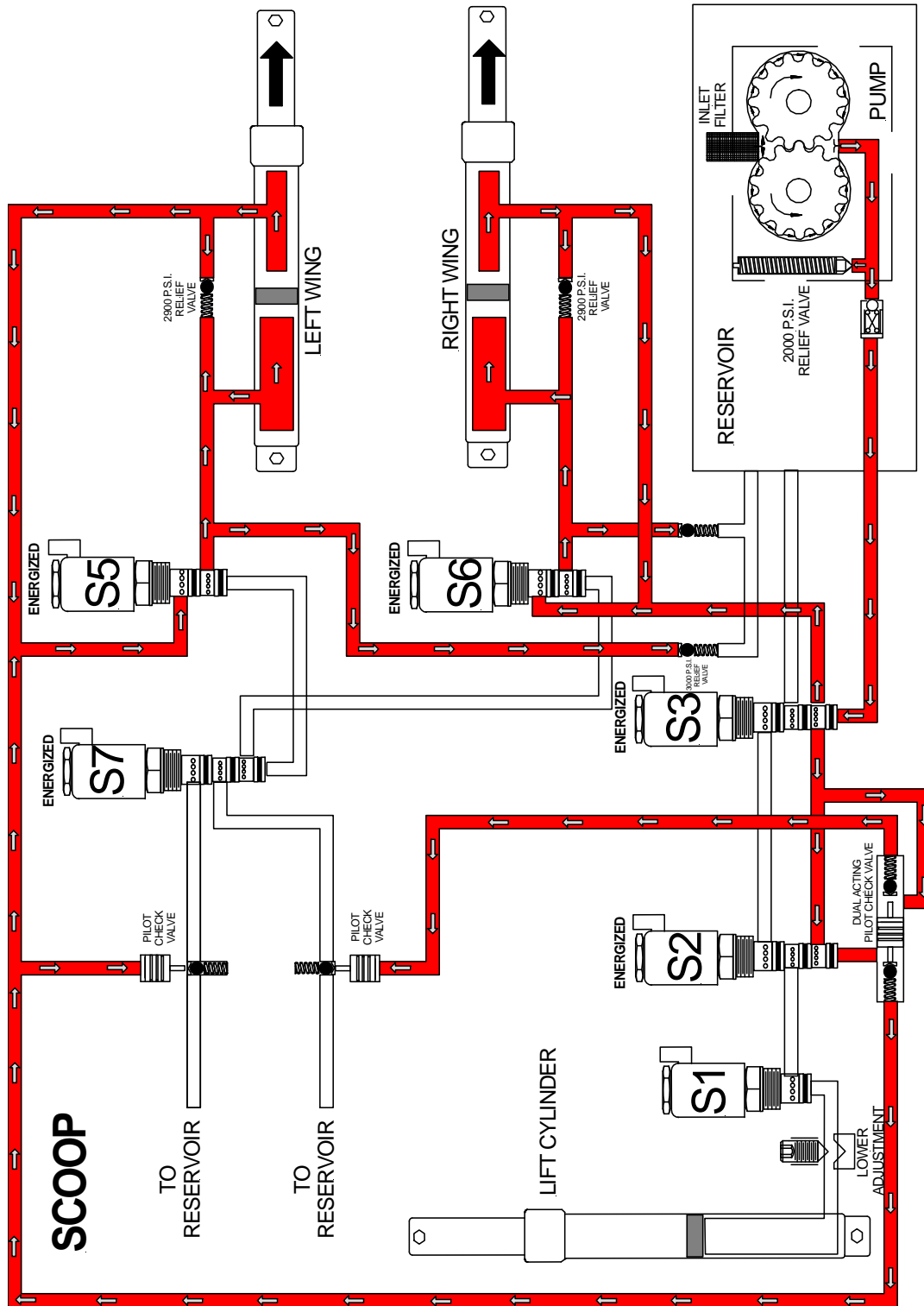

FIGURE 1-9

ELECTRO LIFT® UNIT COMPONENTS

V-70 UNIT COMPONENTS

MOTOR (4-1/2")

Two terminal

The motor is a four pole, electromagnet motor which consists primarily of a 4-1/2" diameter solid steel frame, armature, brushes, field coils and pole pieces. This motor can be used on vehicles with either the common negative ground electrical system or the positive ground electrical system.

HYDRAULIC PUMP

The pump in a hydraulic system employs an external source of power to apply a force to a liquid. A pump develops no power of its own. It simply transfers power from an external source (the electric motor on the V-70 unit) to the liquid in the hydraulic system.

The basic operating principles of the hydraulic pump used in the V-70 unit is quite simple. Figure 1-11 illustrates the basic components of a positive displacement gear type pump and their functions. The pumping action takes place within the pump chamber which is connected to the reservoir by the intake line. The pump chamber has an outlet line in which the liquid under motion and pressure leaves the pump to perform work.

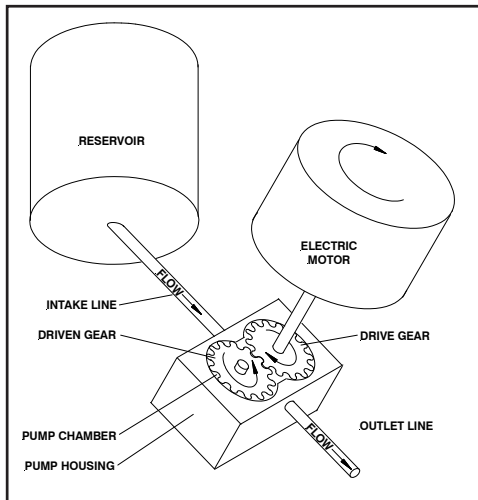

FIGURE 1-11

PRESSURE RELIEF VALVE

A basic pressure relief valve is shown in Figure 1-12. It consists of a poppet valve and a valve spring. Both are located in a passage which connects the inlet passage to the outlet passage. The poppet valve is normally held closed by the valve spring, sealing the connecting passage from the pressurized outlet passage. The poppet valve, being a piston, is exposed to the pressurized hydraulic fluid in the outlet passage. Whenever the hydraulic pressure against the poppet valve becomes greater than the pressure being exerted

on the poppet valve from the opposite direction by the valve spring, the poppet valve will open. This allows some of the pressurized hydraulic fluid to flow through the connecting passage to the non pressurized inlet passage. The effect is to lower the pressure in the outlet passage which will allow the valve spring to close the poppet valve again.

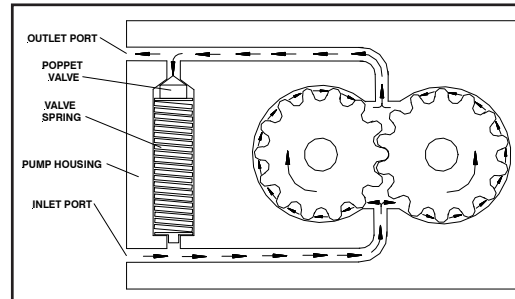

FIGURE 1-12

Under a condition, such as when a hydraulic cylinder is extended to the end of its stroke, eliminating additional space for the pressurized hydraulic oil to be pumped into, the alternate opening and closing of the poppet valve controls the pump's pressure output and provides an escape for the pressurized hydraulic fluid.

The pressure relief valve used in the V-70 pump, while more sophisticated than the one described, functions in the same manner. The pump pressure relief valve may be pre-set and adjustable to the specified pressure of 2000 P.S.I.

SOLENOID VALVES

Hydraulic valves are simple in concept and all have the same basic function: Control the direction of oil flow.

Each Solenoid Valve consists of two components: the Cartridge and the Coil.

Cartridge

The Cartridge consists of the hydraulic valve mechanism and an armature which enables the valve mechanism to be operated and controlled electrically. The Cartridge is designed to screw in and out of the V-70 unit much like the typical "spark plug".

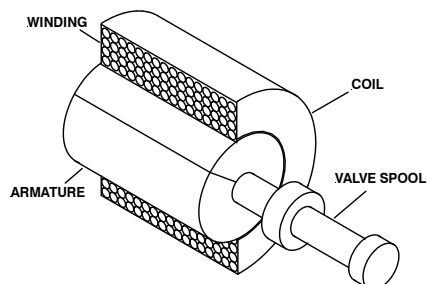

FIGURE 1-13

ELECTRO LIFT® UNIT COMPONENTS CONT.

Coil

The Coil is the electrical component which operates the Cartridge's valve mechanism by producing magnetism which pulls the Cartridge's armature toward it. Since the armature is connected to the valve mechanism's only moving part, it is pulled by the armature.

Figure 1-13 illustrates the typical Coil. Whenever electrical current flows to the Coil, it flows through the winding, which consists of numerous turns of copper wire. The flow of current through the winding produces a magnetic field which pulls the soft iron armature further into the Coil.

The armature pulls the valve spool or poppet valve into its alternate (energized) position. Not illustrated is an integral coil spring, which is compressed when the armature is pulled by the magnetism.

When the current flow ceases, the magnetic field disappears and the compressed coil spring pushes the armature back to its original (de-energized) position.

CHECK VALVES

Check valves are very simple devices that have two basic functions: They prevent fluid from passing through them in one direction, but they allow fluid to pass through them in the opposite direction.

In the V-68 a pump check valve is used to prevent hydraulic fluid from leaking back through the pump to the reservoir.

DOUBLE ACTING PILOT CHECK VALVE

The pilot check valve is more sophisticated in that it incorporates a piston in addition to the ball, seat and spring. The pilot check valve opens a passage way using hydraulic pressure which applies force to a piston which then pushes a ball off its seat to allow fluid to pass thru.

CROSSOVER RELIEF VALVE

When plowing snow, a snow plow can be exposed to damaging forces caused by impact with hidden obstructions, ends of curbs, etc. With power angling, these damaging forces can damage not only the snow plow but also the vehicle. The crossover relief valve has the function of protecting the snow plow system against these damaging forces under normal snow plowing conditions. The crossover relief valve, cannot protect the system from damaging forces that are too great due to abusive snow plowing conditions.

Basically, the crossover relief valve functions exactly like the previously described pump relief valve. It's

designed to open at a specific pressure. In this instance, the pressure is not produced by the pump but rather by the damaging force. As an example, assume that the right corner of the plow runs into the end of a curb. The impact will attempt to collapse the right power angling cylinder. As a result, very high hydraulic pressure is produced within the cylinder. When the produced pressure is high enough, it opens the crossover relief valve, allowing the highly pressurized hydraulic fluid to flow directly to the left power angling cylinder.

When the crossover relief valve functions in this manner, the excessive pressure is released, the excessive energy produced by the impact is absorbed, and the result is only a change in angled position of the plow.

The crossover relief valve is factory set to the specified pressure of 2900 & 3000 P.S.I. this setting is adjustable.

SOLENOID SWITCH

The V-70 motor requires more current or amperage to operate than the vehicle wiring, vehicle ignition switch or toggle switches have the capacity to handle. The solenoid switch is essentially a heavy duty switch with the capacity to handle the heavy current required by the motor. It is closed electrically by the solenoid to convey the heavy current directly from the vehicle battery via heavy gauge electrical cable. The solenoid, which functions essentially the same as the previously described solenoid valves, receives its low amperage current at the proper times via the wiring harness. This solenoid must be grounded to operate properly.

FILTERS

Cleanliness is perhaps the single most important ingredient in assuring a hydraulic system's reliability. Should the hydraulic fluid become contaminated, malfunction and permanent damage to the hydraulic system may occur. For this reason, the V-70 unit is equipped with a filter system consisting of:

- A fine screen strainer on the reservoir pump inlet.

With this system, the hydraulic fluid is filtered as it leaves the reservoir on its way to the pump. Periodic cleaning of the filter screen is achieved by removing the reservoir tank shown in the dis-assembly section.

IMPORTANT:

Should the hydraulic fluid become contaminated, it will be necessary to replace all the hydraulic oil in the system. The complete system (hydraulic unit, power angling cylinders and hoses) should be flushed. Flush the system with Meyer Hydra-Flush™ Fluid M-2.

SECTION 2 - DIAGNOSIS

CONTENTS

GENERAL INFORMATION	19
TESTING TIPS	19
TROUBLE SHOOTING	20-35

DIAGNOSTIC FLOW CHART FOR V-70 Unit

These charts are intended to be used as an aid in diagnosing problems on the V-68 unit. They are not a substitute for factory training and experience. Be certain to read the General Information and Testing Tips sections before attempting any troubleshooting.

IMPORTANT: Maintenance and repairs must be performed with the moldboard on the ground.

General Information

Before any troubleshooting is started, make certain the following conditions are met.

1. The power angling cylinders must be installed correctly on to the plow assembly. The left cylinder (Driver's side) has two hoses. Attach the left wing 1/4" hose to the rod or live end of left ram. Attach the left wing 3/8" hose to the fixed end of left ram. Attach the right wing 1/4" hose to the rod or live end of right ram. Attach the right wing 3/8" hose to the fixed end of right ram. See Figure 1
2. The solenoid wires must be on their proper coil. See Figure 2

Figure 1

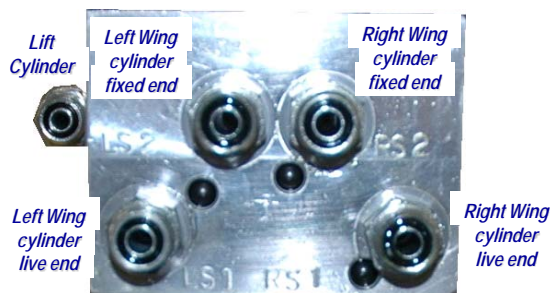
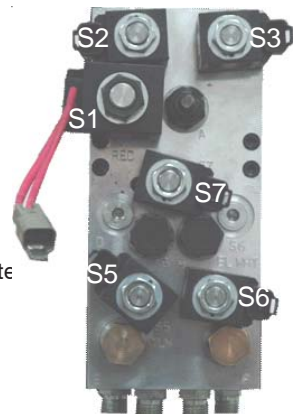

Figure 2

Hydraulic Solenoid Color Code:

- S1 (Red and Black w/white stripe)
- S2 (Black and Black w/white stripe)
- S3 (Green and Black w/white stripe)
- S5 (Yellow and Black w/white stripe)
- S6 (Blue w/white stripe and Black w/white stripe)
- S7 (Purple and Black w/white stripe)



TESTING TIPS

Many tests do not require removing the Electro Lift® unit from the vehicle. However, more thorough testing can be performed using the Meyer Test Stand which allows direct pressure and amperage readings.

1. Using a screwdriver or other small tool to check for magnetism of the solenoid coils "S1", "S2", "S3", "S5", "S6" and "S7". Place the tool on the nut securing the coil and have an assistant operate the switch. You should feel strong magnetic attraction.
2. Use a test light or volt meter to determine whether there is power at the harness.
3. When determining AMP draw of the motor, always obtain the highest value possible, i.e. at maximum raise or maximum angle with motor running.
4. The pump shaft of a good pump can be turned smoothly using two fingers. If it can't be turn easily, the pump is too tight and must be replaced.
5. Pump pressure can be measured at an angle hose (note pressure at full angle) Note: The V-70 Unit has a adjustable pressure relief valve.
6. Flush the complete system including unit, hoses and power angling rams with Meyer Hydra-Flush™ Fluid M-2.

V-70 CONTROLLER OPERATION

- The snow plow should only be in operation when the vehicle ignition switch and the control switch are in the "ON" position. Care should be taken to insure that the control switch is kept dry and free from moisture during normal operation.
- When the control switch is turned "On," lights illuminate the location of the individual touch pads for the functions of the snow plow: (Up), (Angle Left), (Left Extend), (Left Retract), (Angle Right), (Right Extend), (Right Retract), (Scoop), (Vee) and (Down).
- Lowering of the snow plow an inch at a time is possible by tapping the down arrow in short intervals. Holding down the down arrow will activate a float light located in the upper right corner of the control switch. This light indicates the snow plow is now in the Lower/Float position. In this position the snow plow will be able to follow the contour of the road and the snow plow can also be angled to the left or right. Touching the up arrow automatically cancels the Lower/Float position.
- While angling left or right or raising the snow plow if the button is pressed for more than six seconds the operation will be cancelled. This feature eliminates unnecessary amp draw from the vehicle charging system.
- This switch is self diagnosing. The monitor light is located in the upper left corner next to the float light of the control switch. When the monitor light turns on and begins to flash the control switch is sensing a problem with a specific coil/connection on the hydraulic unit. The label below is on the back side of your control switch.
- Reset is accomplished by turning off the ignition switch or by turning the power switch off momentarily and then back on. If the monitor light is still illuminated after attempts to reset the switch have failed, contact your nearest authorized Meyer Distributor for repairs.

V-68	RAISE	LOWER	RIGHT RETRACT	RIGHT EXTEND	LEFT RETRACT	LEFT EXTEND	ANGLE RIGHT	ANGLE LEFT	VEE	SCOOP
MOTOR	X		X	X	X	X	X	X	X	X
S1	X	X								
S2	X	X							X	X
S3		X	X	X			X		X	X
S5						X				X
S6				X						X
S7			X		X				X	X

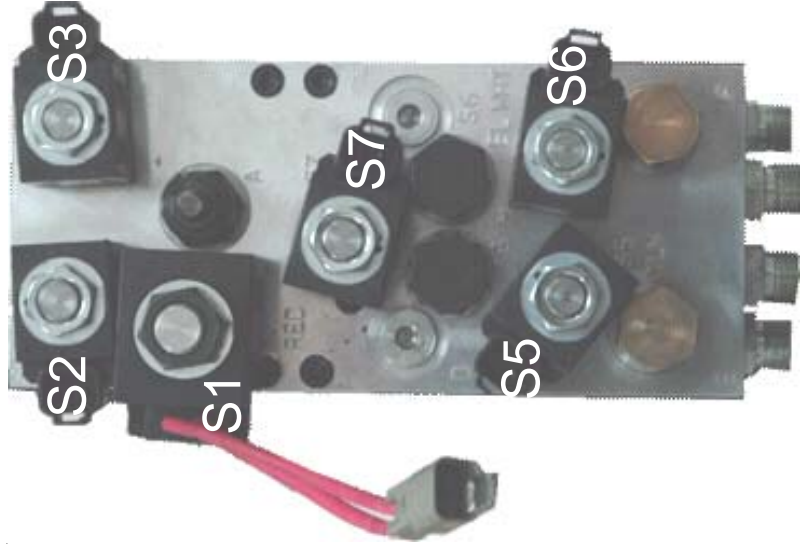

V-70 Operation Chart

V-68	RAISE	LOWER	RIGHT RETRACT	RIGHT EXTEND	LEFT RETRACT	LEFT EXTEND	ANGLE RIGHT	ANGLE LEFT	VEE	SCOOP
MOTOR	X		X	X	X	X	X	X	X	X
S1	X	X								
S2	X	X							X	X
S3		X	X	X			X		X	X
S5						X				X
S6				X						X
S7			X		X				X	X

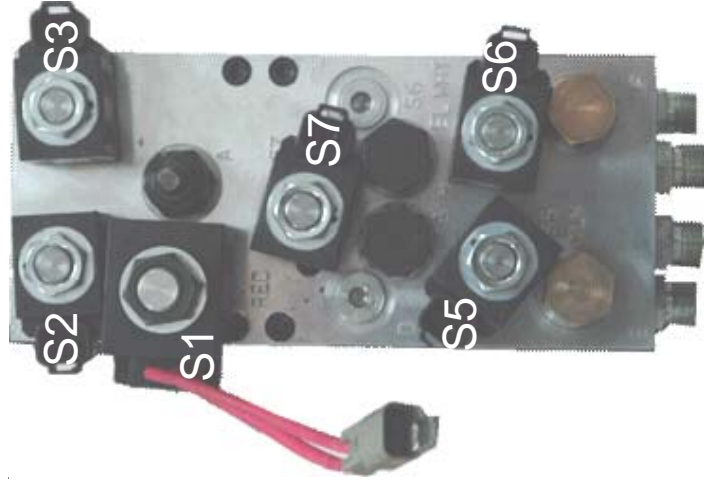

S1 Solenoid Failure
Red and Black w/White Stripe

No Raise or Lower

V-68	RAISE	LOWER	RIGHT RETRACT	RIGHT EXTEND	LEFT RETRACT	LEFT EXTEND	ANGLE RIGHT	ANGLE LEFT	VEE	SCOOP
MOTOR	X		X	X	X	X	X	X	X	X
S1	X	X								
S2	X	X							X	X
S3		X	X	X			X		X	X
S5						X				X
S6				X						X
S7			X		X				X	X

**S2 Solenoid Failure
Black and White Stripe**

**No Raise, Lower,
Vee or Scoop**

**Press Vee Function
the plow will retract
right wing**

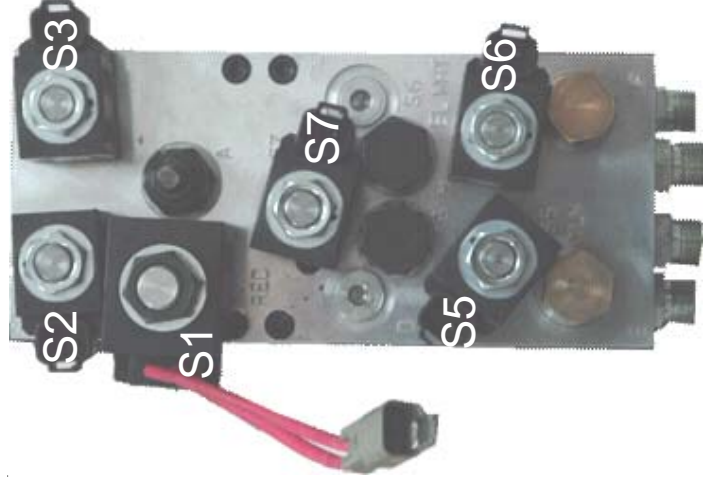

V-68	RAISE	LOWER	RIGHT RETRACT	RIGHT EXTEND	LEFT RETRACT	LEFT EXTEND	ANGLE RIGHT	ANGLE LEFT	VEE	SCOOP
MOTOR	X		X	X	X	X	X	X	X	X
S1	X	X								
S2	X	X							X	X
S3		X	X	X			X		X	X
S5						X				X
S6				X						X
S7			X		X				X	X

S3 Solenoid Failure
Green and Black w/White Stripe

No Lower, Right Retract, Right Extend, Right Angle, Vee or Scoop

Press Right Retract **Press Angle**
the plow will retract **Right the plow**
left wing **will angle left**

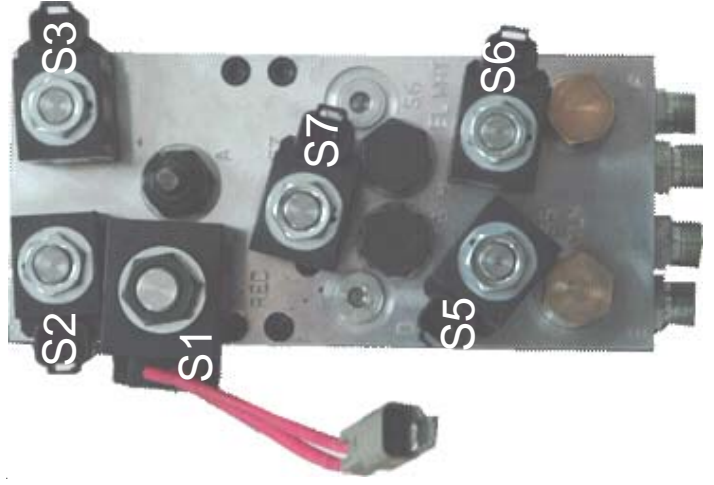

V-68	RAISE	LOWER	RIGHT RETRACT	RIGHT EXTEND	LEFT RETRACT	LEFT EXTEND	ANGLE RIGHT	ANGLE LEFT	VEE	SCOOP
MOTOR	X		X	X	X	X	X	X	X	X
S1	X	X								
S2	X	X							X	X
S3		X	X	X			X		X	X
S5						X				X
S6				X						X
S7			X		X				X	X

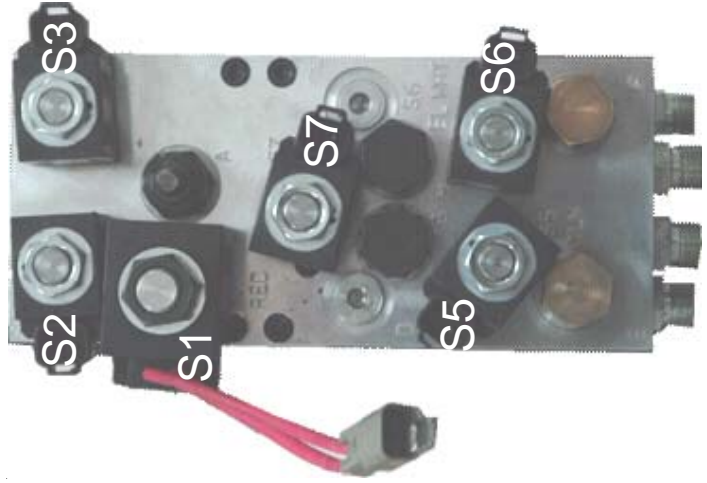

S5 Solenoid Failure
Yellow and Black w/White Stripe

No Left Extend
or Scoop

Press Left Extend
the plow will
angle Left

V-68	RAISE	LOWER	RIGHT RETRACT	RIGHT EXTEND	LEFT RETRACT	LEFT EXTEND	ANGLE RIGHT	ANGLE LEFT	VEE	SCOOP
MOTOR	X		X	X	X	X	X	X	X	X
S1	X	X								
S2	X	X							X	X
S3		X	X	X			X		X	X
S5						X				X
S6				X						X
S7			X		X				X	X

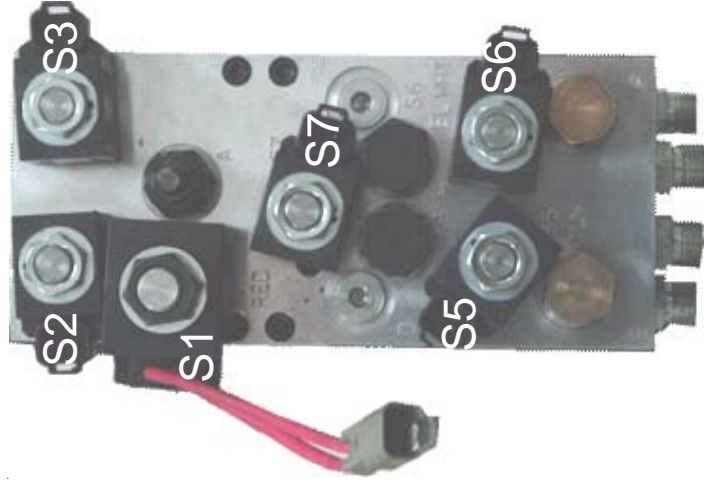

S6 Solenoid Failure
Blue w/White Stripe and
Black w/White Stripe
No Right Extend
or Scoop
 Press Right
 Extend the plow
 will angle Right

V-68	RAISE	LOWER	RIGHT RETRACT	RIGHT EXTEND	LEFT RETRACT	LEFT EXTEND	ANGLE RIGHT	ANGLE LEFT	VEE	SCOOP
MOTOR	X		X	X	X	X	X	X	X	X
S1	X	X								
S2	X	X							X	X
S3		X	X	X			X		X	X
S5						X				X
S6				X						X
S7			X		X				X	X

S7 Solenoid Failure
Purple and Black w/White Stripe

No Right Retract, Left Retract, Vee or Scoop

Press Right Press Left Retract
Retract the plow the plow will
will angle right angle left

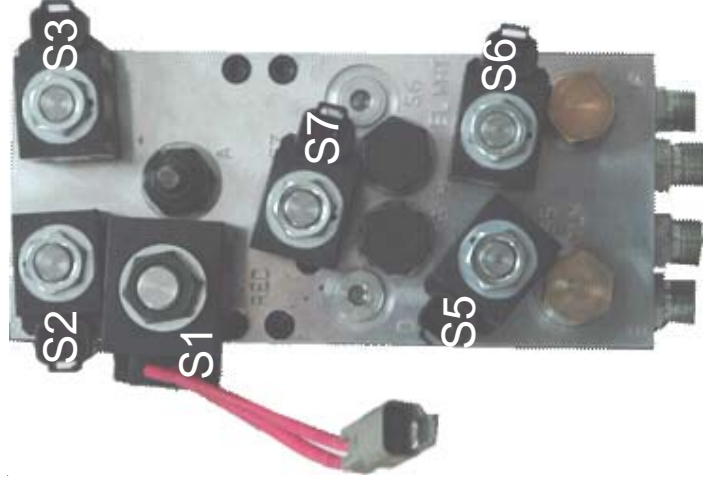

Snow Plow will not Raise

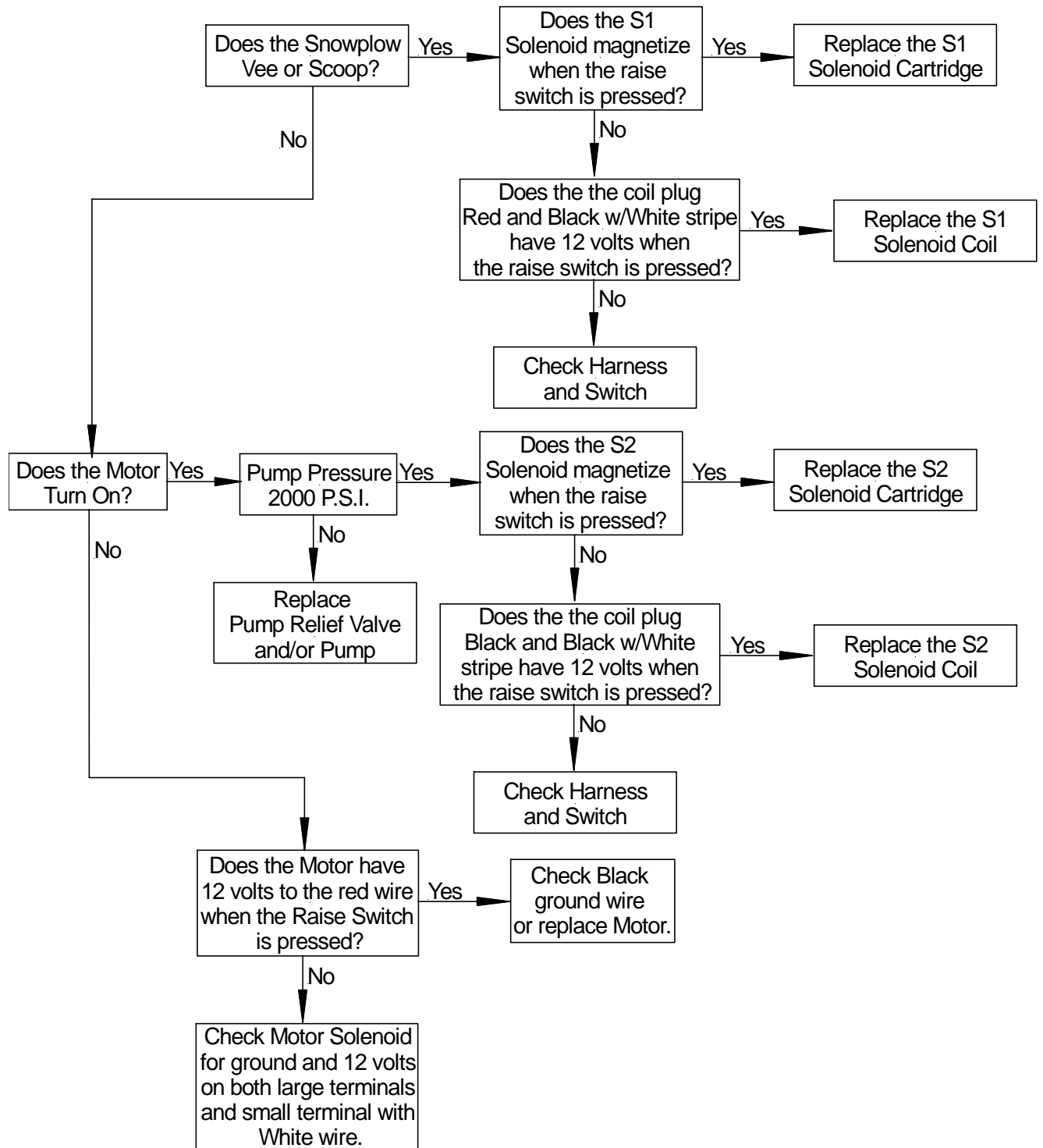

Snow Plow will not Lower

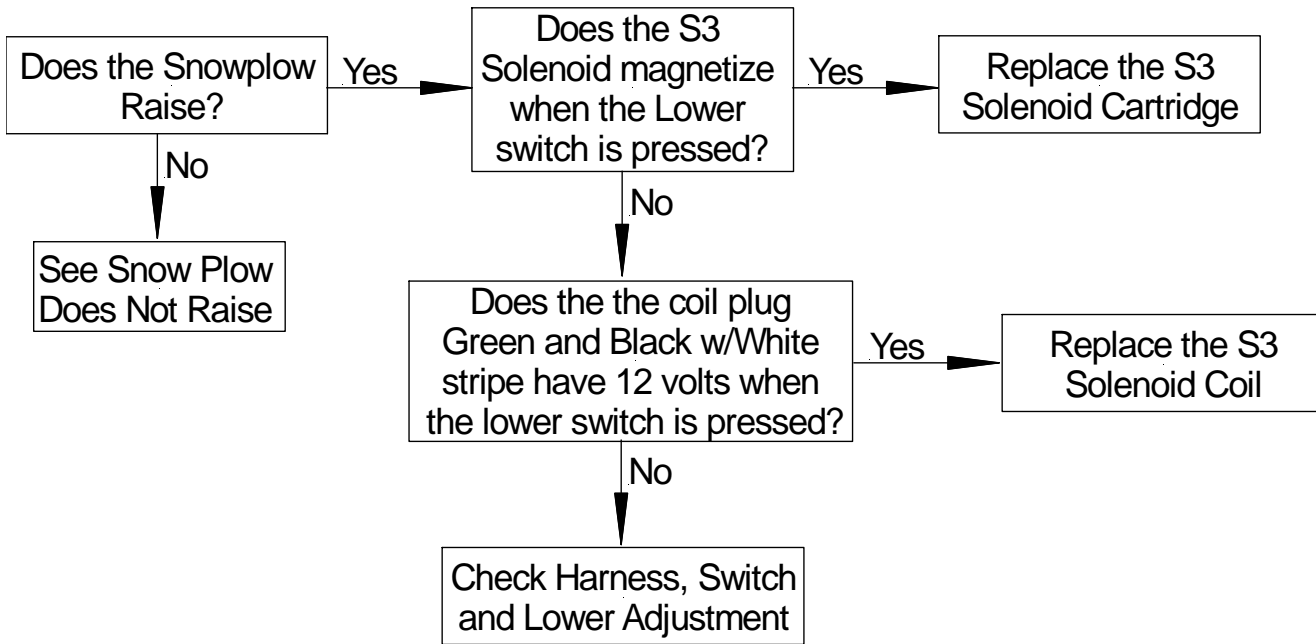

Snow Plow Leaks Down

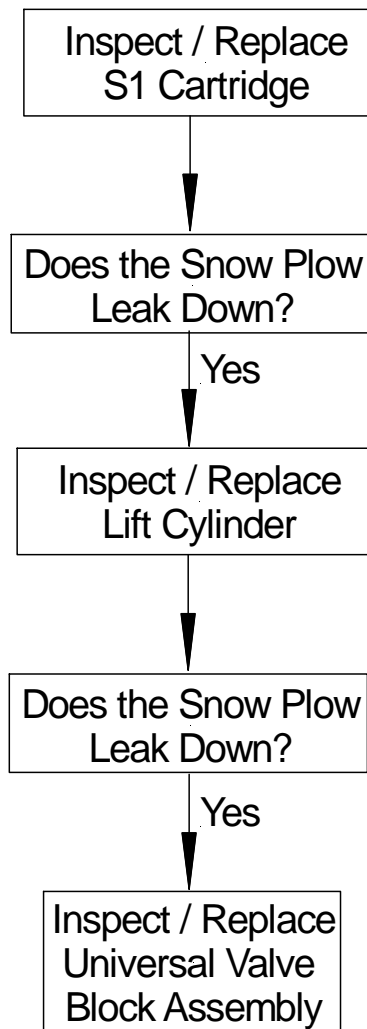

Snow Plow will not Angle Left

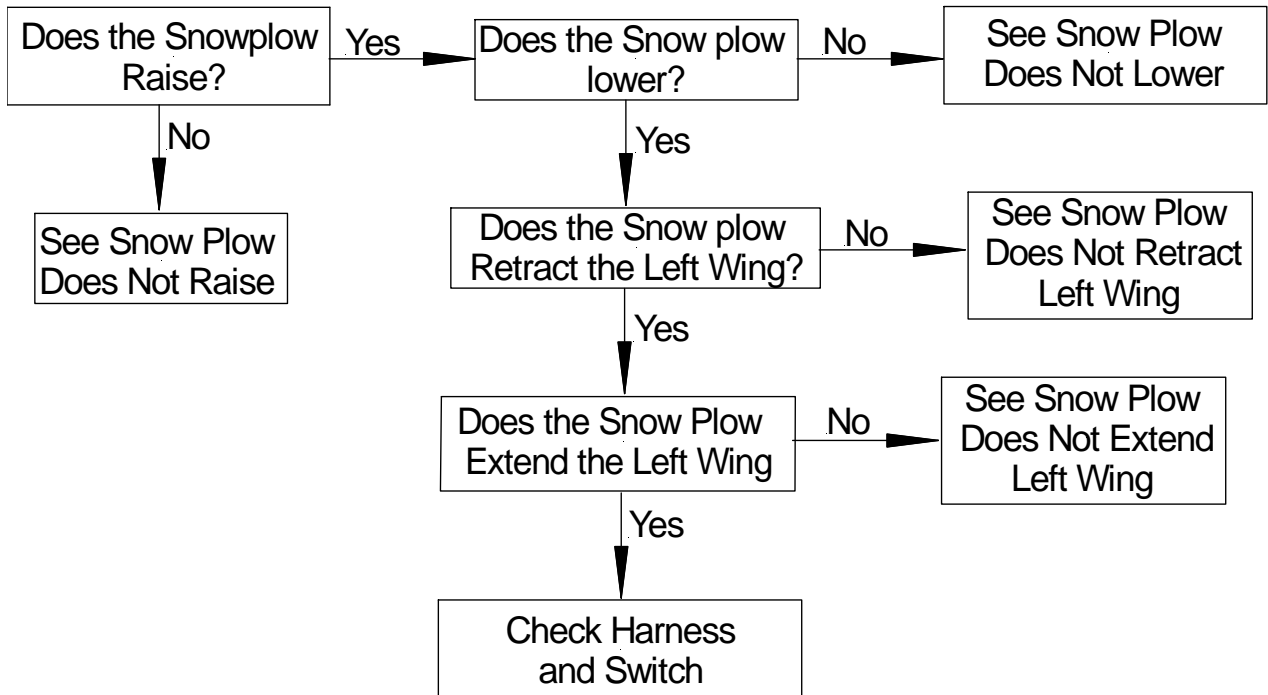

Snow Plow will not Extend the Left Wing

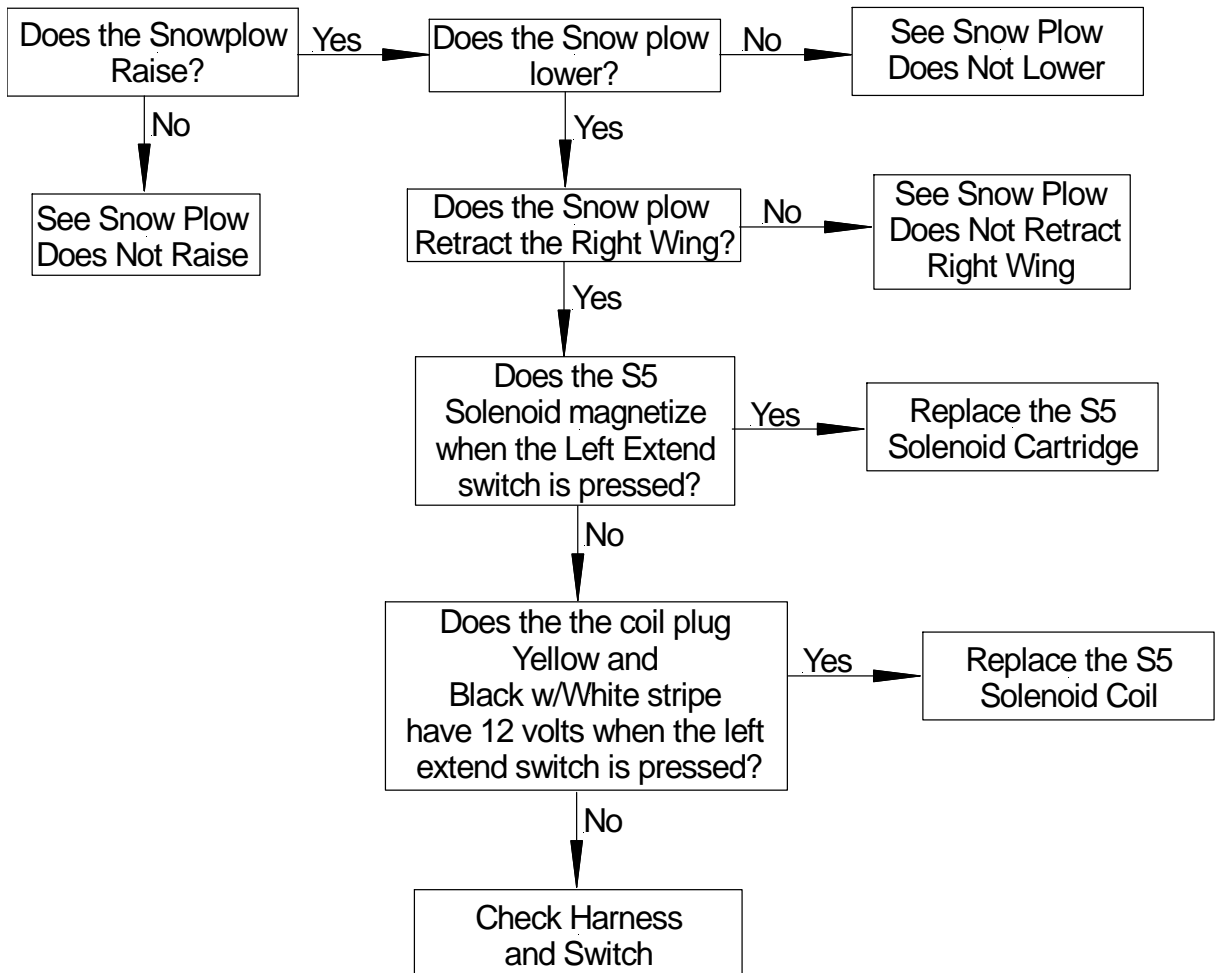

Snow Plow will not Retract the Left Wing

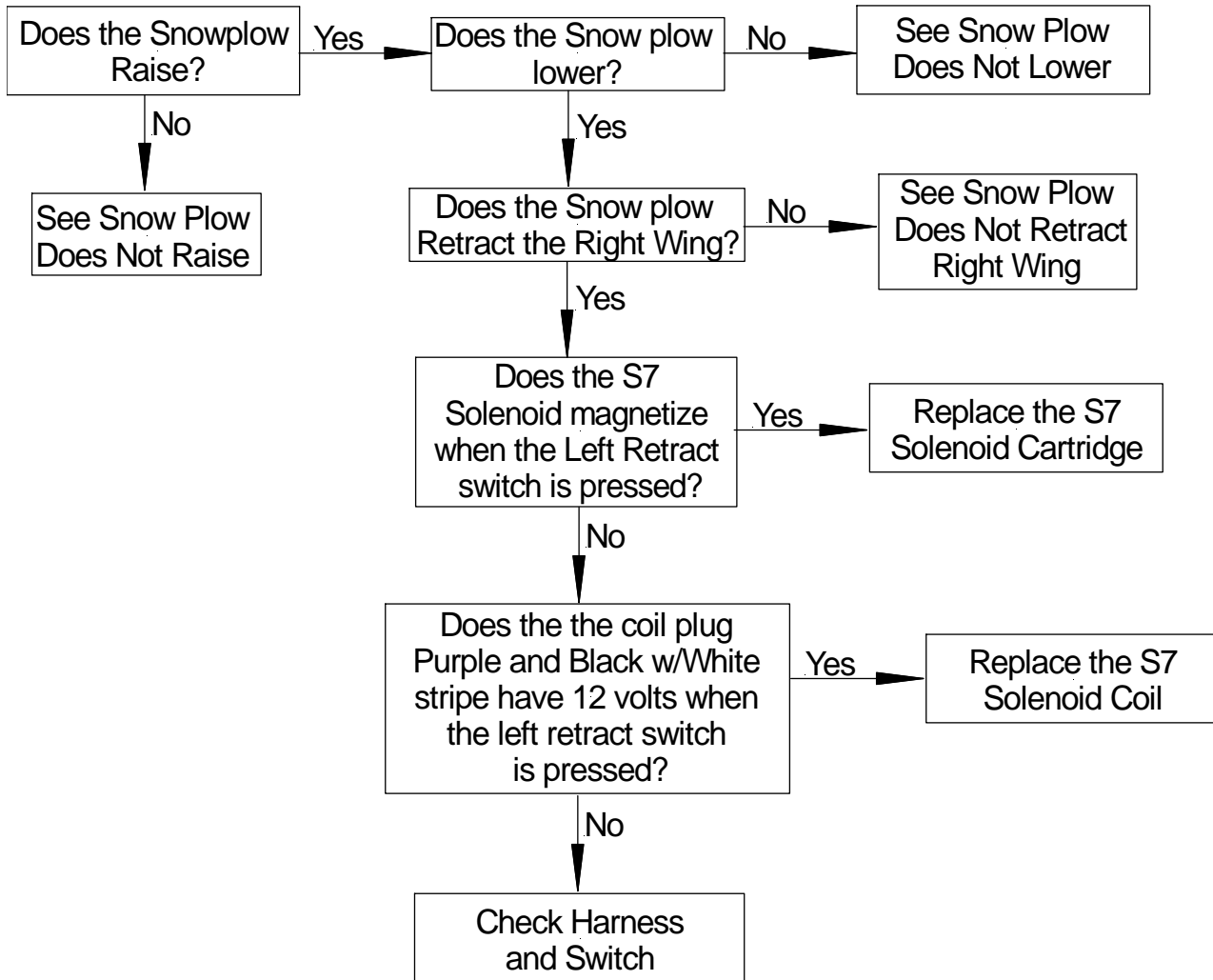

Snow Plow will not Angle Right

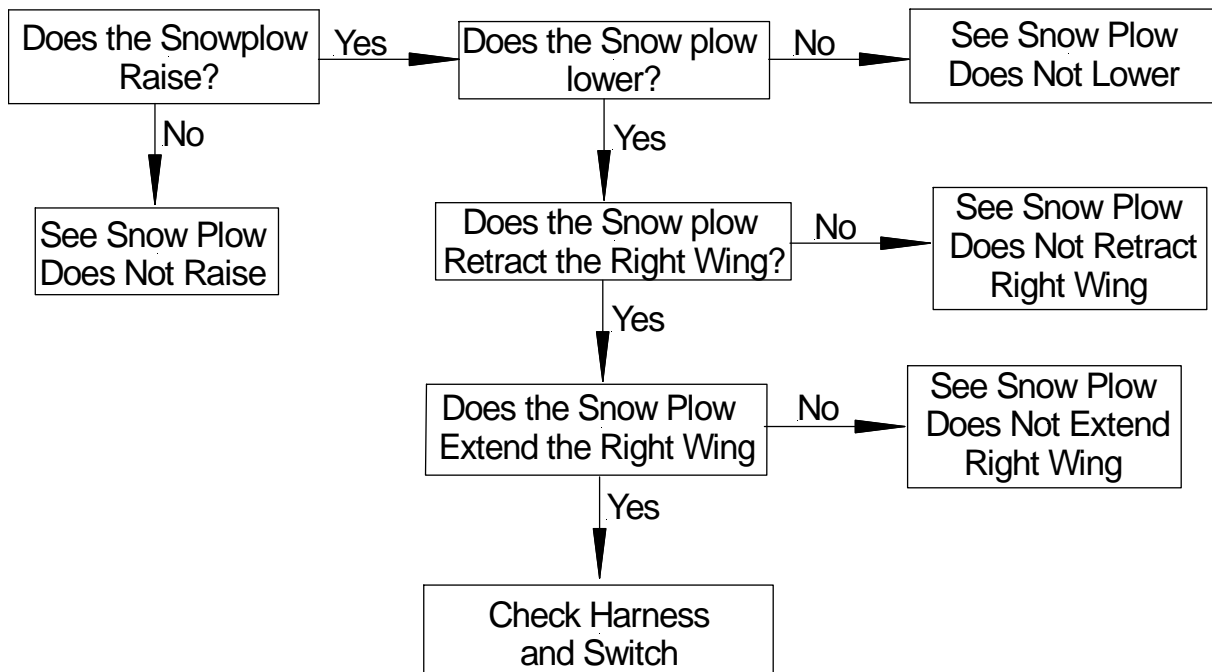

Snow Plow will not Extend the Right Wing

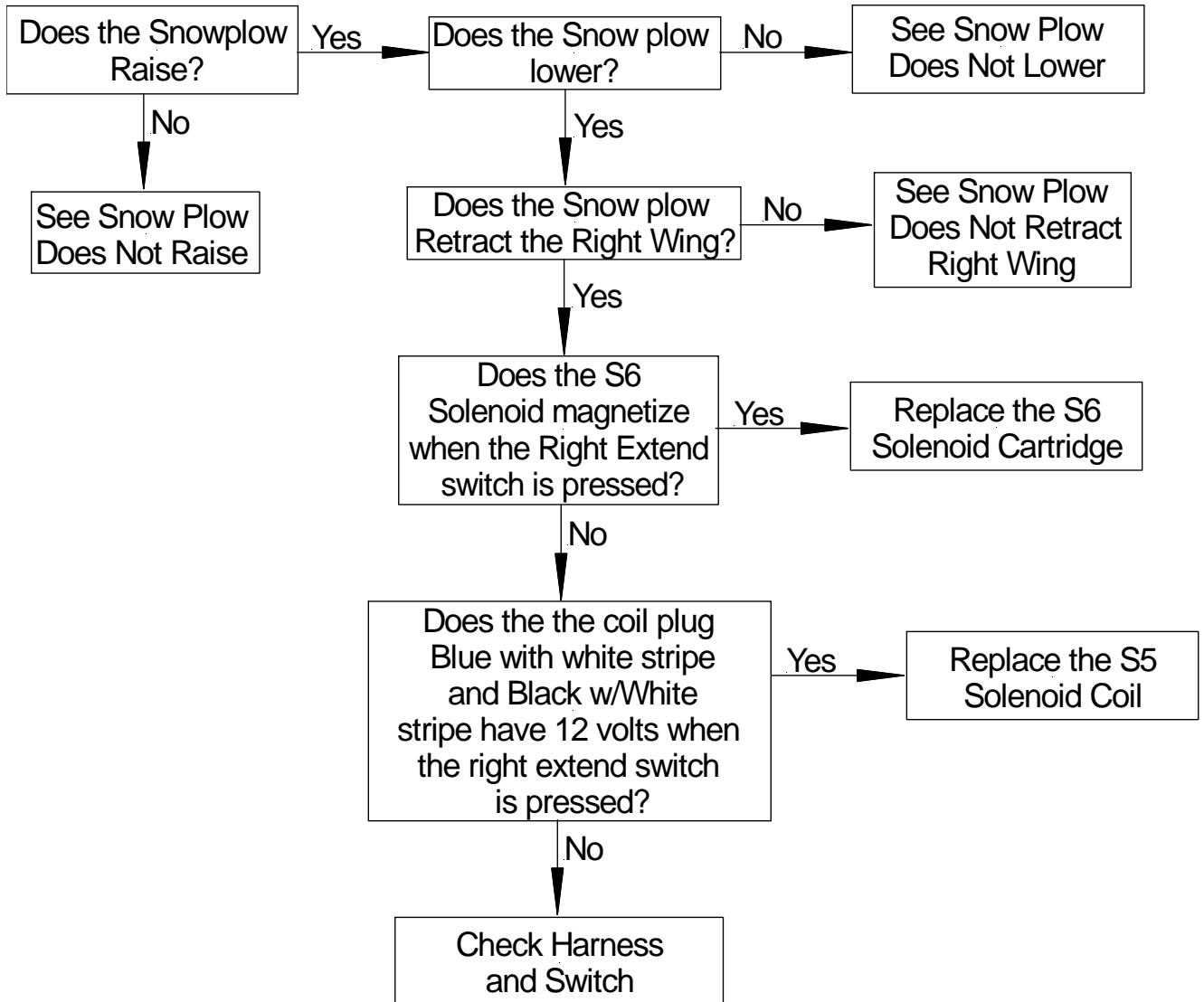

Snow Plow will not Retract the Right Wing

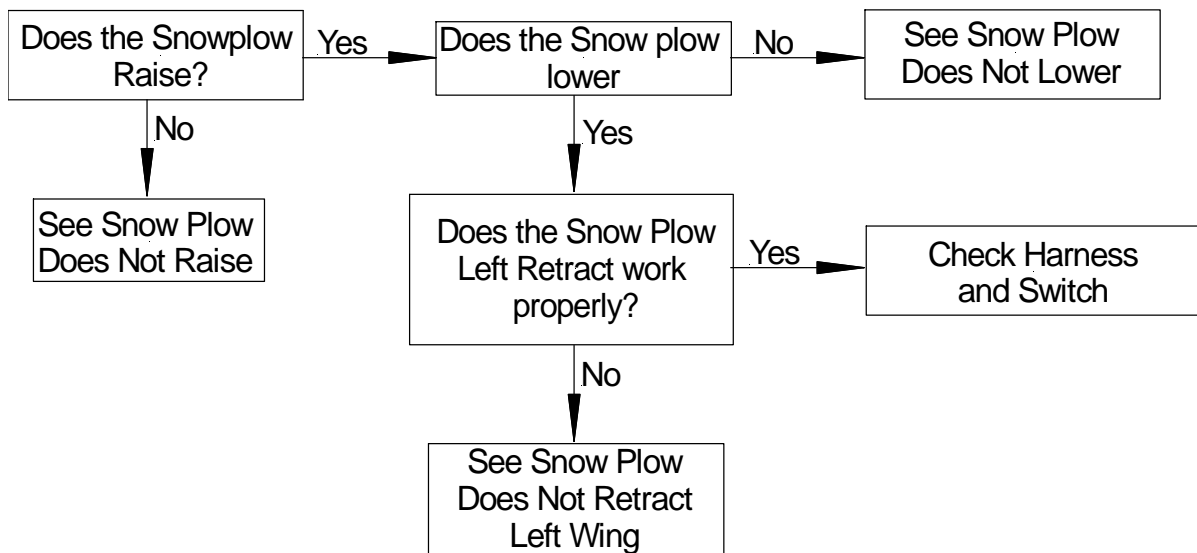

Snow Plow will not Scoop

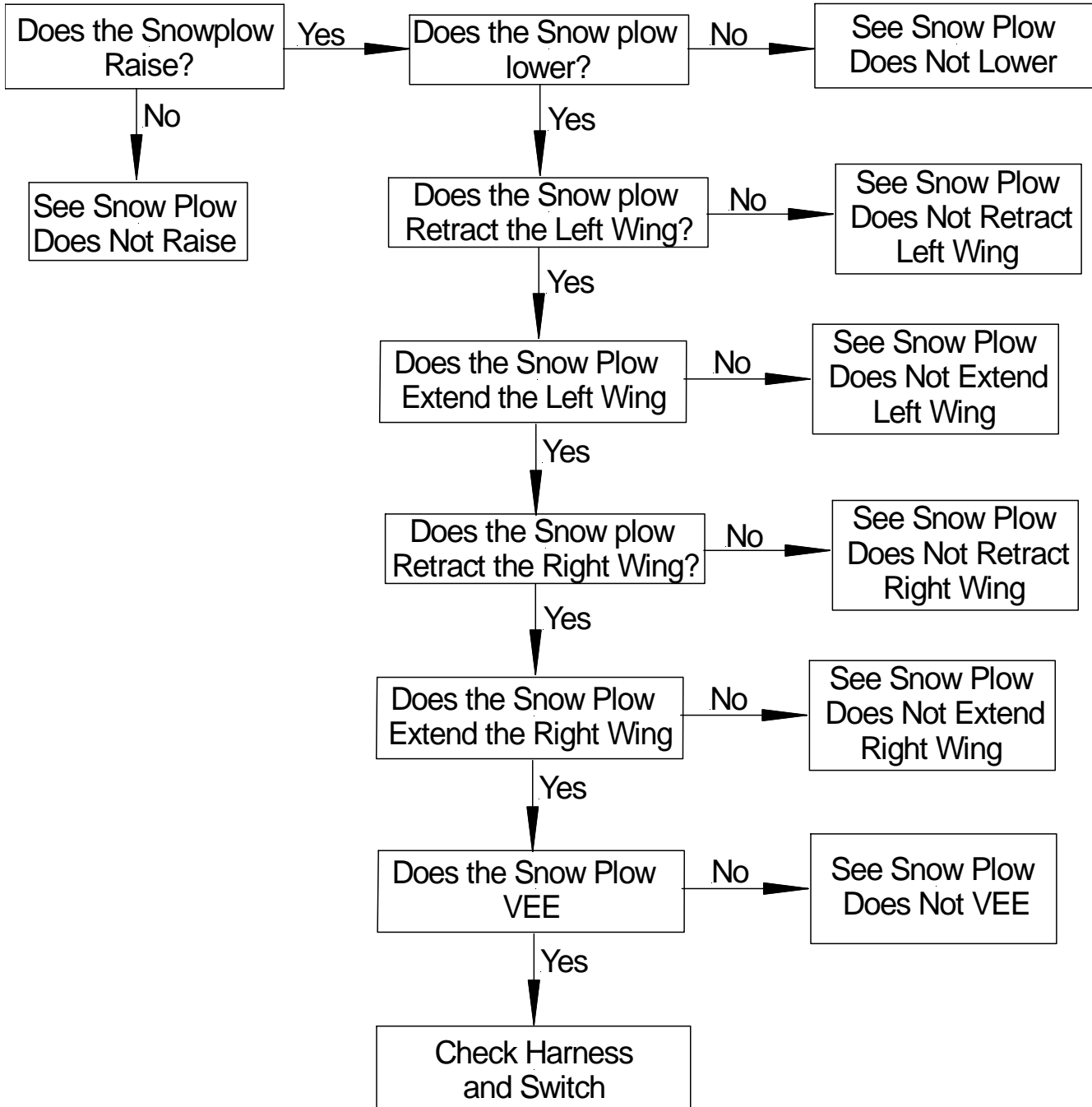

Snow Plow will not VEE

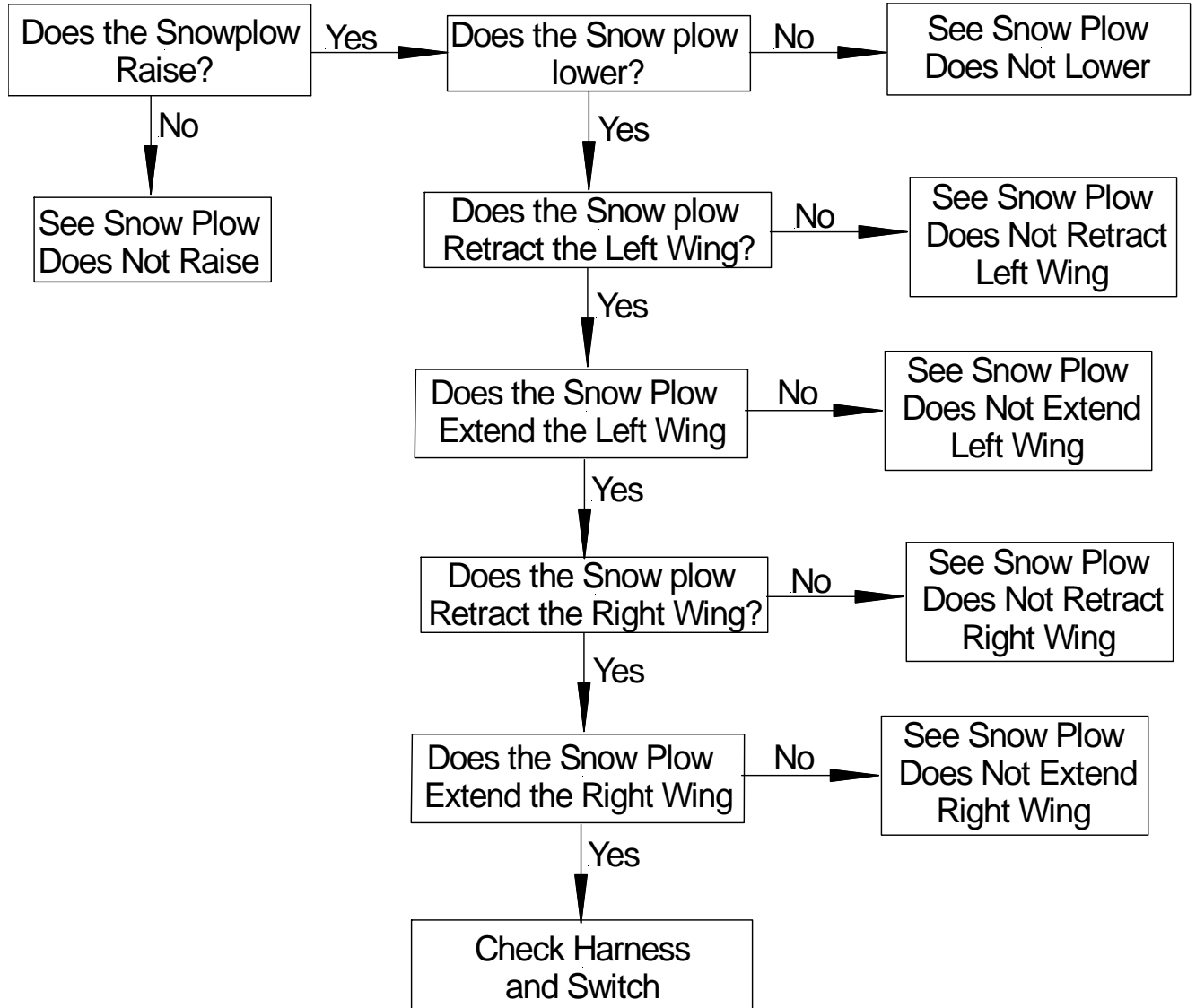

Snow Plow Wing Does Not Hold Position

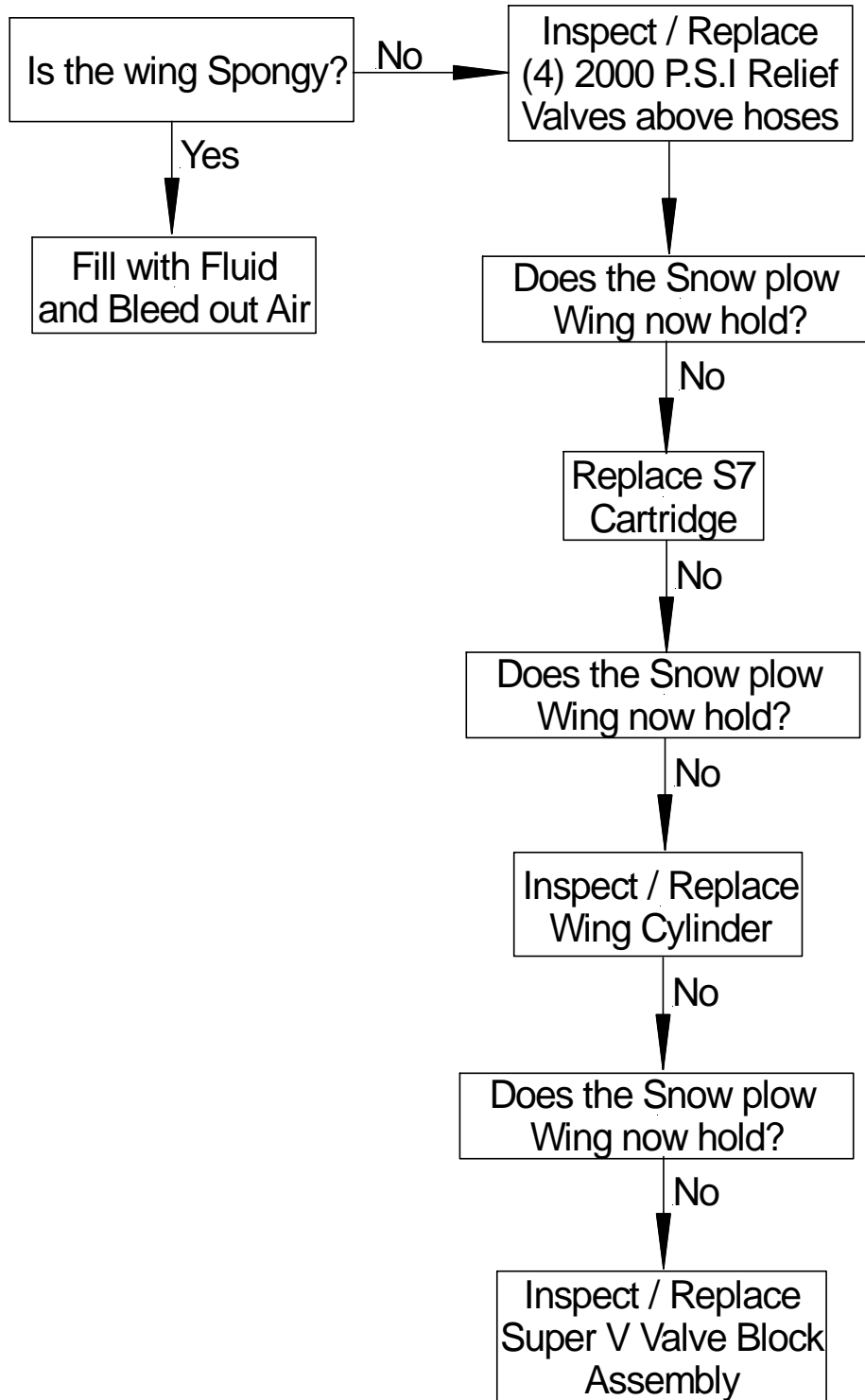

V-70 Wiring

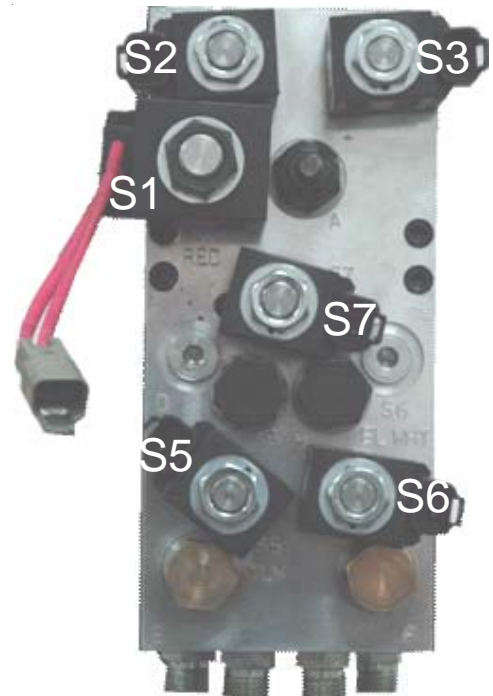
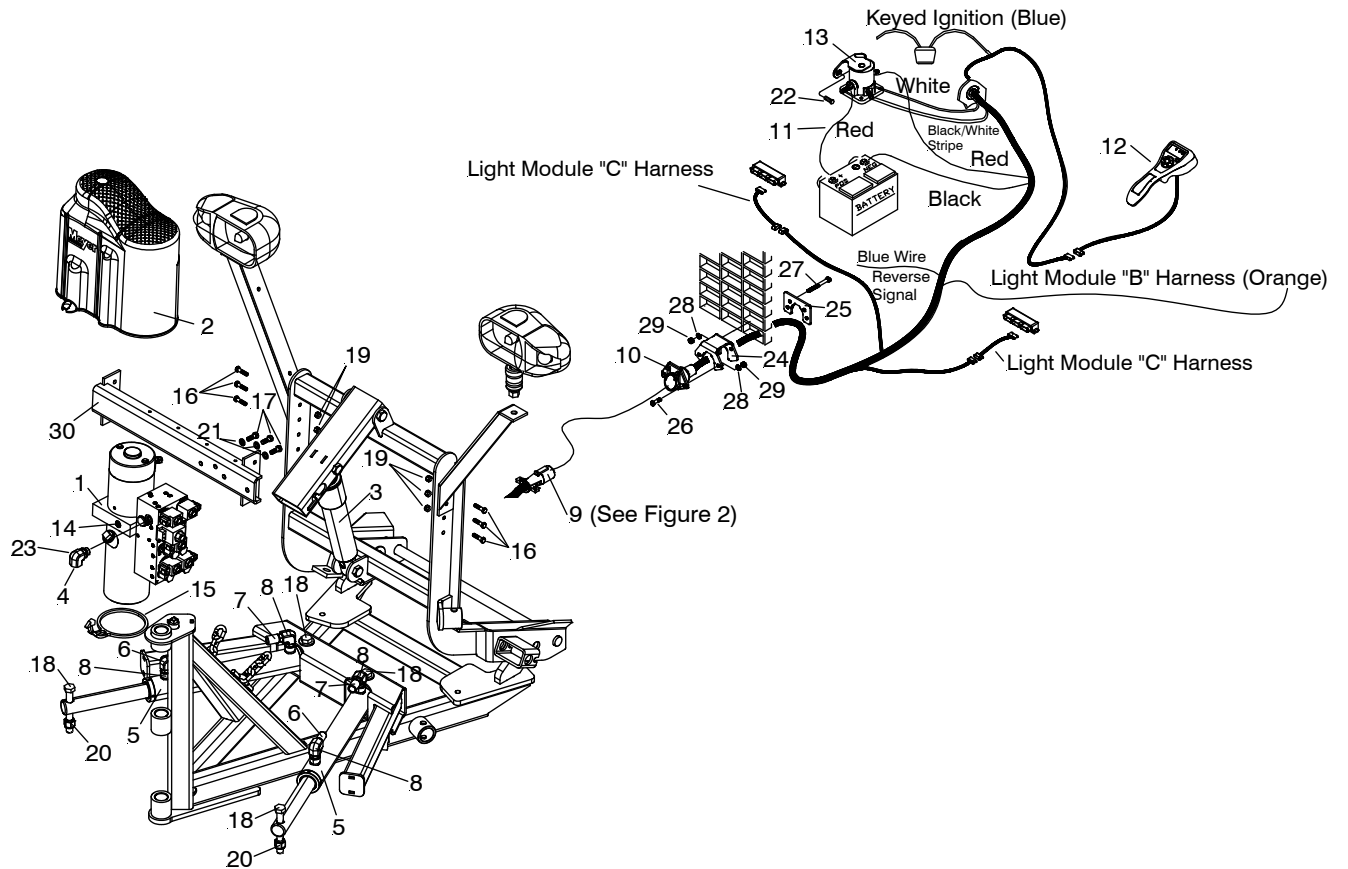

Hydraulic Solenoid Color Code:

- S1 (Red and Black w/white stripe)
- S2 (Black and Black w/white stripe)
- S3 (Green and Black w/white stripe)
- S5 (Yellow and Black w/white stripe)
- S6 (Blue w/white stripe and Black w/white stripe)
- S7 (Purple and Black w/white stripe)

SECTION 3 - REPAIR PROCEDURES

CONTENTS

GENERAL INFORMATION	37
UNIT DISASSEMBLY AND REASSEMBLY	37
Disassembly	37
Reassembly	37
• Additional Reassembly Points	37
ELECTRO LIFT®	
Exploded View	38
Parts Breakdown	39
Disassembly Photos	40-54
Reassembly Photos	55-59
SPECIFICATIONS	60

GENERAL INFORMATION

Using the proper guidelines and precautions, the V-70 unit is easy to disassemble and reassemble. Figure 3-1 (page 38) is an exploded view which applies to the V-70. It should be used as the primary reference for proper reassembly. Where necessary, this section includes additional information, photographs and illustrations to assure proper and efficient repairs.

UNIT DISASSEMBLY AND REASSEMBLY

Many repair procedures, including removal and replacement of the "S1", "S2", "S3", "S5", "S6" and "S7" Solenoid Valves, can be accomplished without removing the unit from the vehicle. While Figures 3-3 through 3-82 show the unit clamped in a vise, make all possible repairs on the vehicle when possible.

NOTE: Pump Assembly should not be disassembled since it cannot be serviced.

Disassembly

See Figures 3-2 through 3-61 (pages 40-54).

Reassembly

See Figures 3-62 through 3-81 (pages 55-59) for important reassembly points.

Additional Reassembly Points

- O-Rings- Coat liberally with hydraulic fluid and position carefully to minimize possibility of damage during assembly.
- Fasteners- Torque all fasteners which are specified to insure proper reliability and prevent damage due to over-tightening.

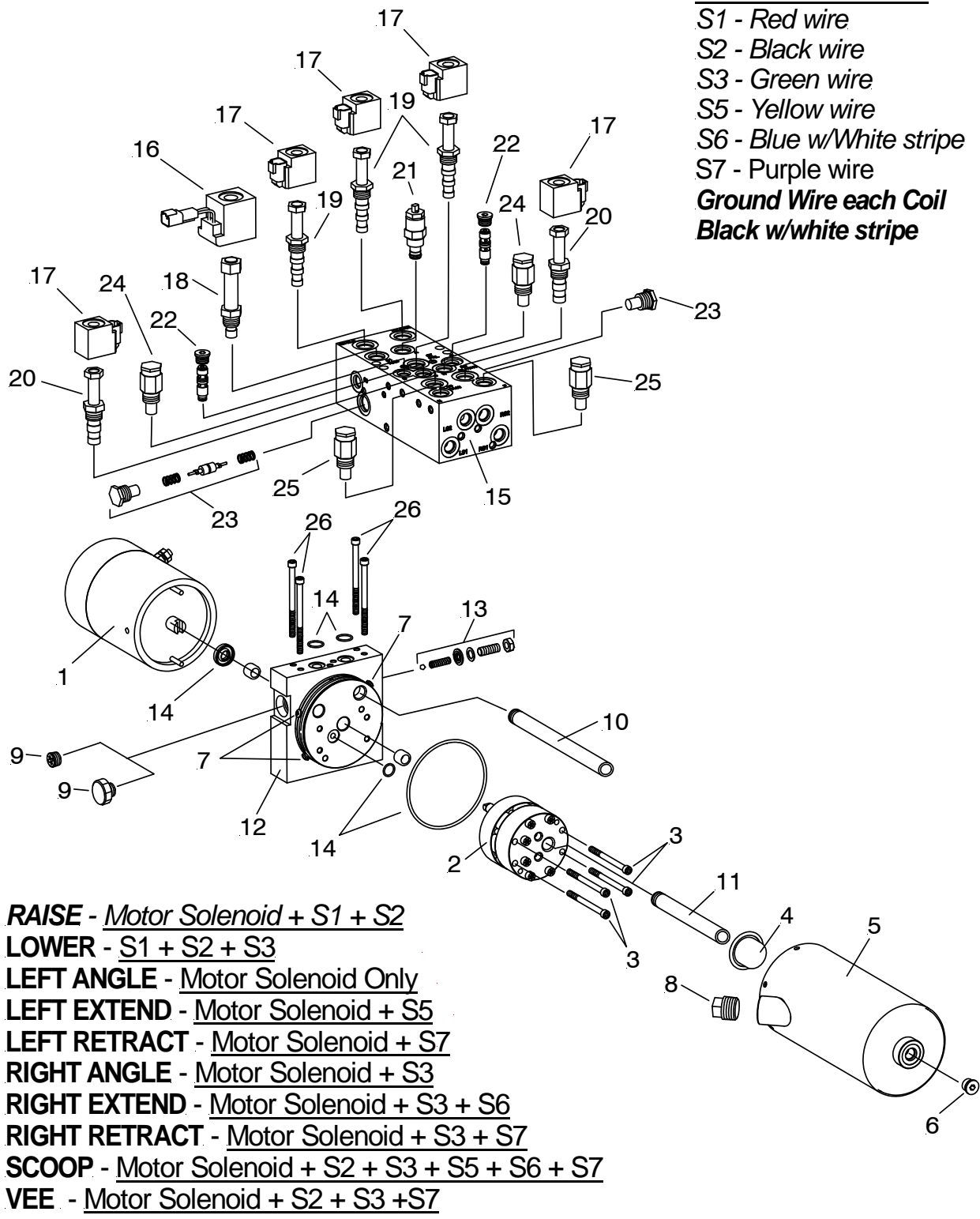

V-70
Exploded View

FIGURE 3-1

PARTS & INSTALLATION INSTRUCTIONS V-70 ELECTRO-LIFT® UNIT

Parts List

ITEM	V-70 12V	V-70 24V	QTY	DESCRIPTION
	15092	15091	1	Lift Assembly (Unit Only)
1	15096	15135	1	• Motor - (2 Terminal)
2	15097	15097	1	• Pump Assembly
3	15083	15083	4	• Allen Head Screw 1/4-20 x 3"
4	15101	15101	1	• Pump Filter Assy.
5	15103	15103	1	• Reservoir
6	15104	15104	1	• Drain Plug
7	15106	15106	5	• Self Tapping Screw 12-24 x 3/8"
8	15108	15108	1	• Fill Plug 3/4-14 NPT
9	15107	15107	1	• Reservoir Breather Steel s/n 0030015088 & earlier
9	15067	15067	1	• Reservoir Breather Plastic s/n 0030115088 & later
10	15099	15099	1	• Oil Tube
11	15100	15100	1	• Oil Tube
12	15095	15095	1	• Base Assembly
13	15121	15121	1	• Adjustable Relief Valve
14	15082	15082	1	• Seal Kit (All Seals)
15	15105	15155	1	• Valve Assembly
16	15079	15139	1	•• Coil "S1"
17	15118	15157	5	•• Coil "S2", "S3", "S5", "S6" & "S7"
18	15112	15112	1	•• "S1" Cartridge Valve
19	15111	15111	3	•• "S2", "S3", "S7" Cartridge Valve
20	15117	15117	2	•• "S5" & "S6" Cartridge Valve
21	15113	15113	1	•• Kit Needle Valve (Lower Adj.)
22	15129	15129	1	•• Kit Dual PO Check Valve
23	15128	15128	1	•• Kit Check Valve Assembly
24	15115	15115	2	•• Kit Relief Valve Assy. 3000 p.s.i.
25	15116	15116	2	•• Kit Relief Valve Assy. 2900 p.s.i.
26	15098	15098	4	• Allen Head Screw 1/4-20 x 3-1/2"

Parts indented are included in assembly under which they are indented.

DISASSEMBLY - V-70



FIGURE 3-2

Remove Drain Plug using a 1/4" allen wrench and drain all the hydraulic fluid from the Base Tank.

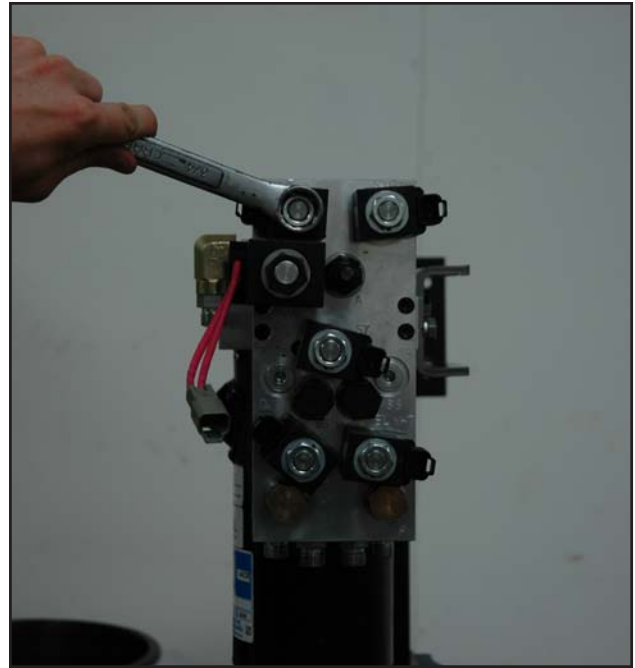

FIGURE 3-3

Remove the "S2" Coil using a 3/4" wrench.

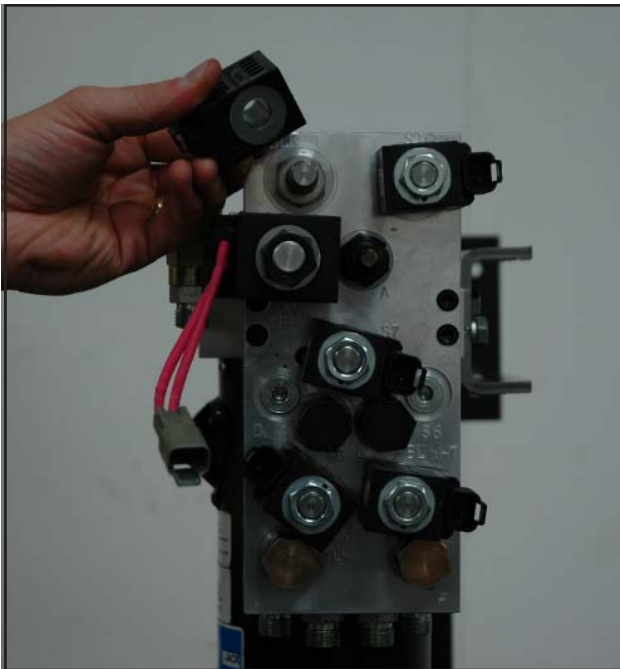

FIGURE 3-4

Coil removed from the "S2" Cartridge.

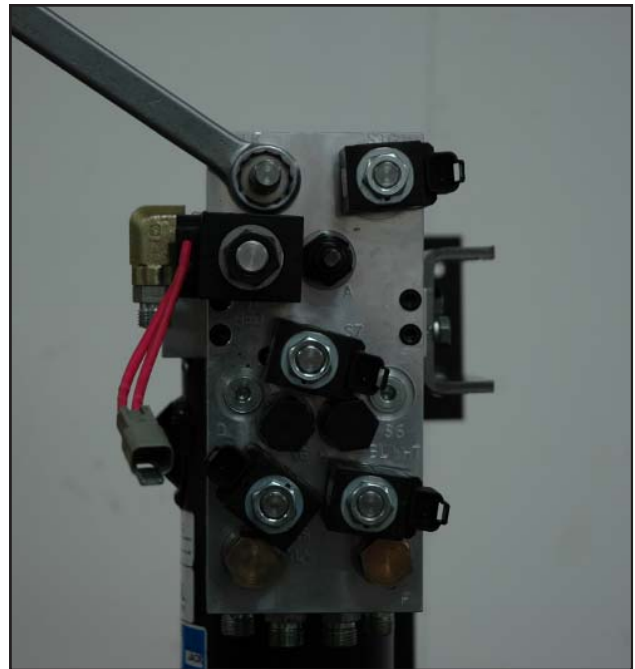

FIGURE 3-5

The "S2" Cartridge is removed using a 7/8" wrench or deep well socket.

DISASSEMBLY - V-70

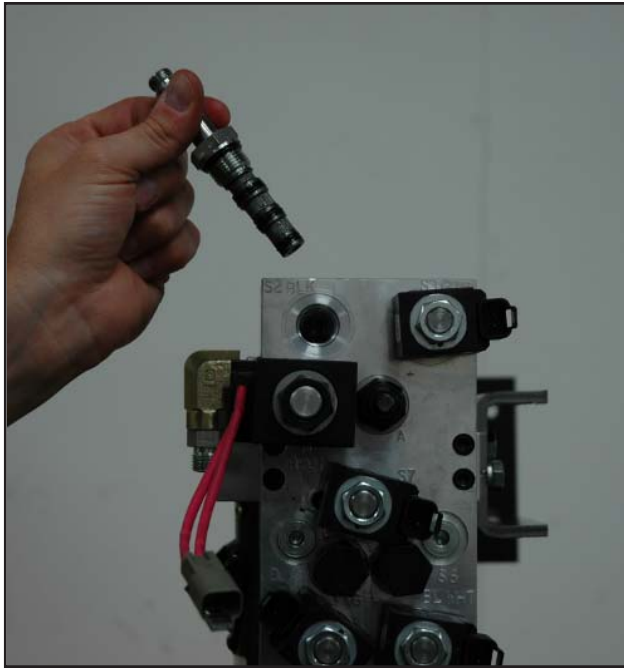

FIGURE 3-6

The "S2" Cartridge is removed. Clean by soaking cartridge in cleaning solvent.

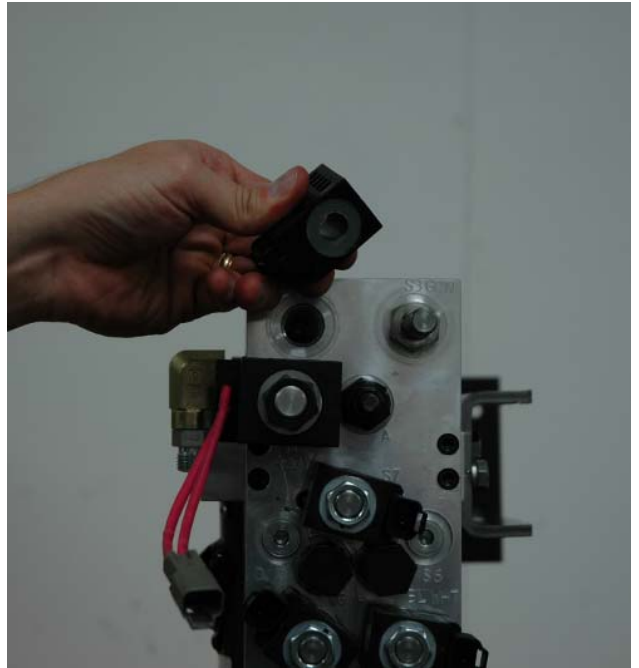

FIGURE 3-7

Coil removed from the "S3" Cartridge.

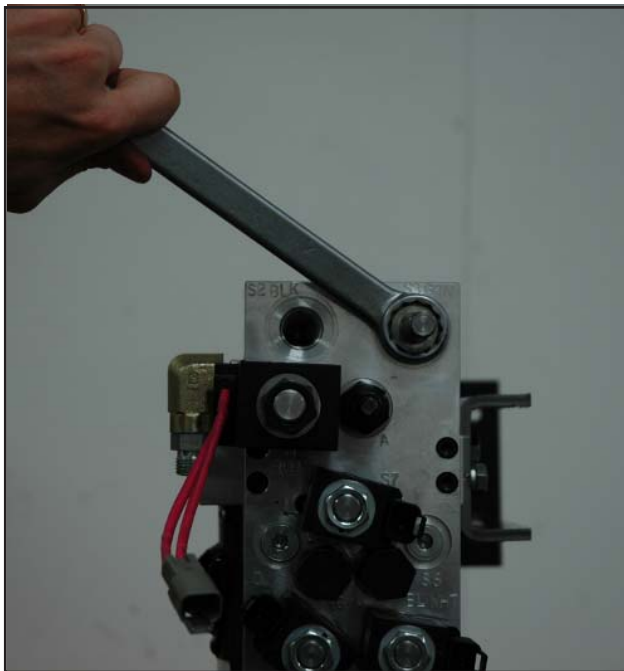

FIGURE 3-8

The "S3" Cartridge is removed using a 7/8" wrench or deep well socket.

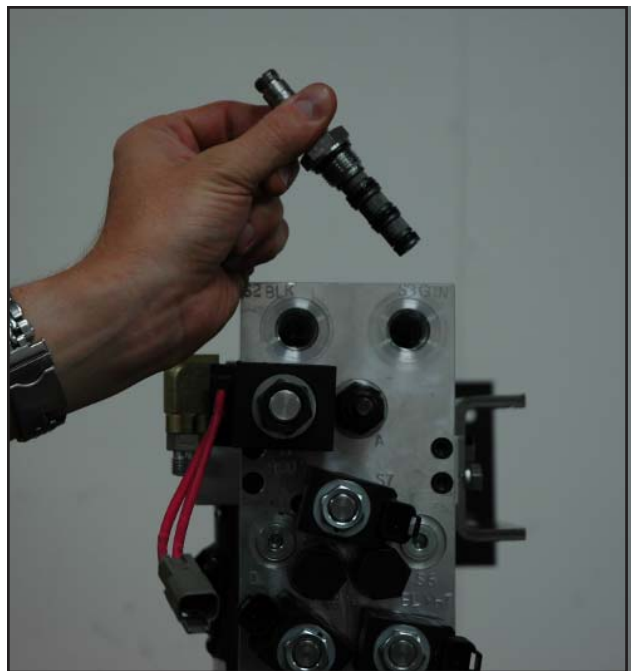

FIGURE 3-9

The "S3" Cartridge is removed. Clean by soaking cartridge in cleaning solvent.

DISASSEMBLY - V-70



FIGURE 3-10
Coil removed from the "S1" Cartridge.

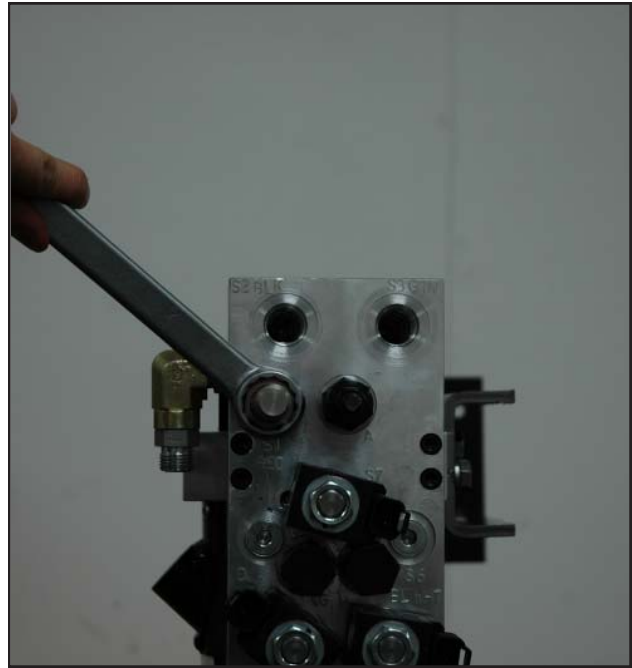

FIGURE 3-11
The "S1" Cartridge is removed using a 7/8" wrench or deep well socket.



FIGURE 3-12
The "S1" Cartridge is removed. Clean by soaking cartridge in cleaning solvent.



FIGURE 3-13
Coil removed from the "S7" Cartridge.

DISASSEMBLY - V-70

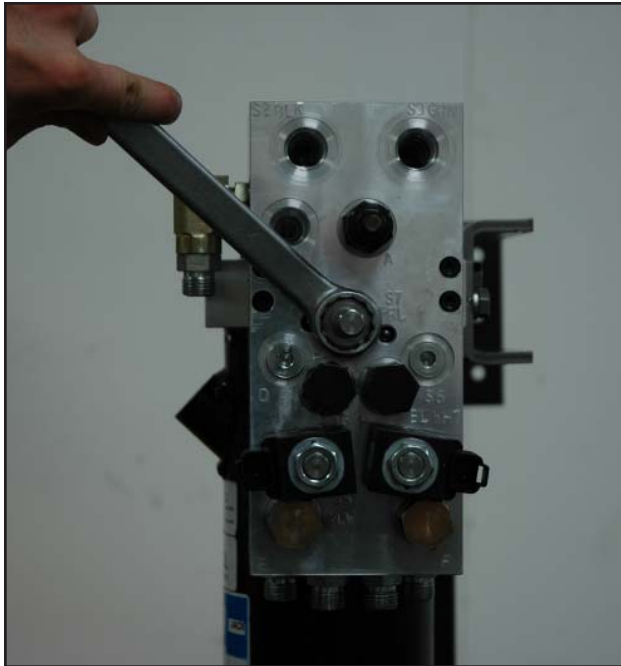

FIGURE 3-14

The "S7" Cartridge is removed using a 7/8" wrench or deep well socket.

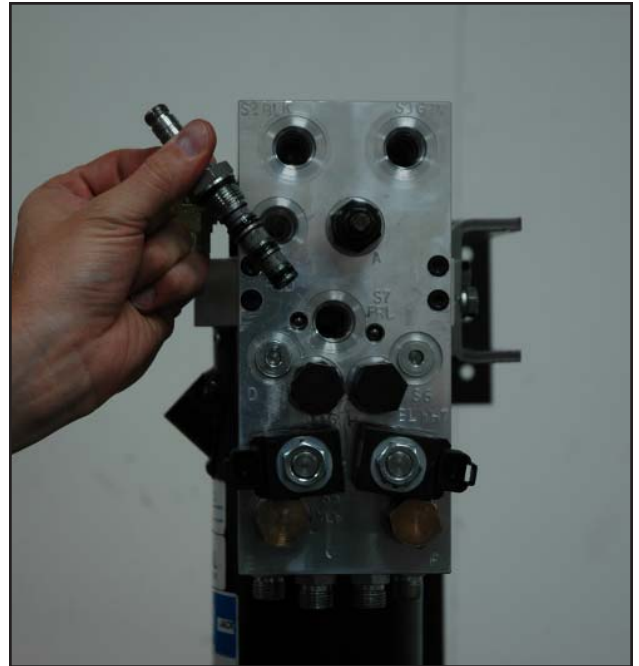

FIGURE 3-15

The "S7" Cartridge is removed. Clean by soaking cartridge in cleaning solvent.

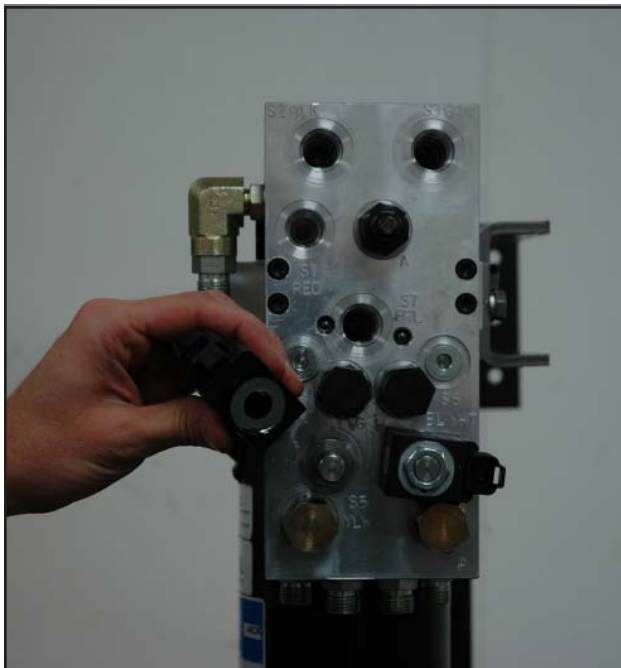

FIGURE 3-16

Coil removed from the "S5" Cartridge.

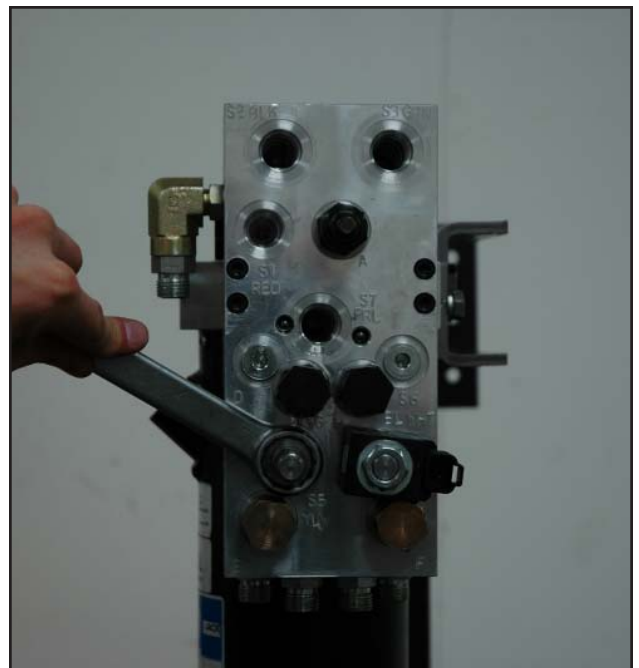

FIGURE 3-17

The "S5" Cartridge is removed using a 7/8" wrench or deep well socket.

DISASSEMBLY - V-70



FIGURE 3-18

The "S5" Cartridge is removed. Clean by soaking cartridge in cleaning solvent.



FIGURE 3-19

Coil removed from the "S6" Cartridge.



FIGURE 3-20

The "S6" Cartridge is removed using a 7/8" wrench or deep well socket.

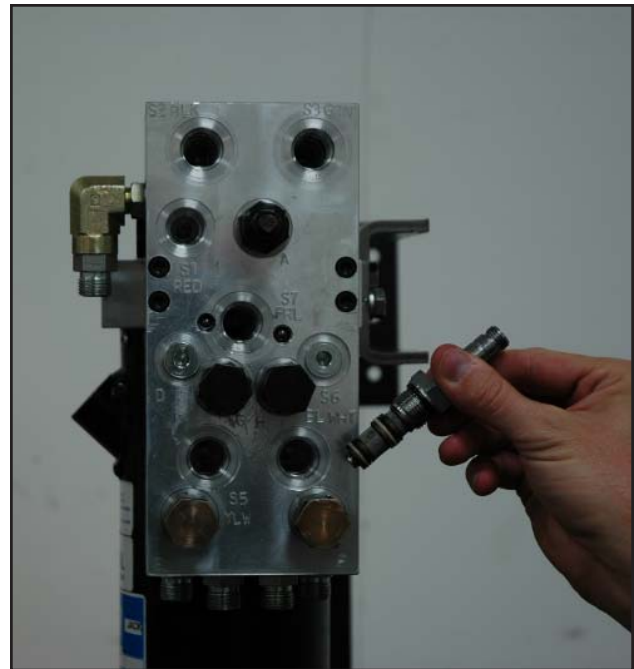

FIGURE 3-21

The "S6" Cartridge is removed. Clean by soaking cartridge in cleaning solvent.

DISASSEMBLY - V-70

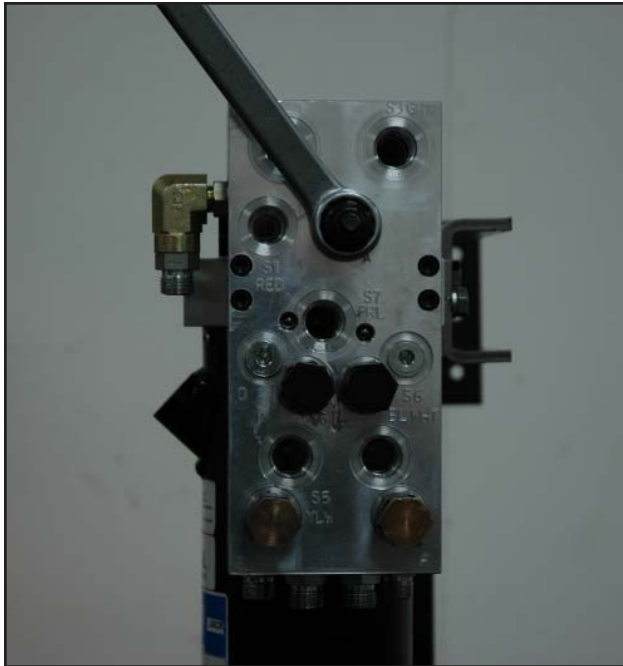

FIGURE 3-22

Using a 7/8" wrench loosen and remove lower adjustment assembly.

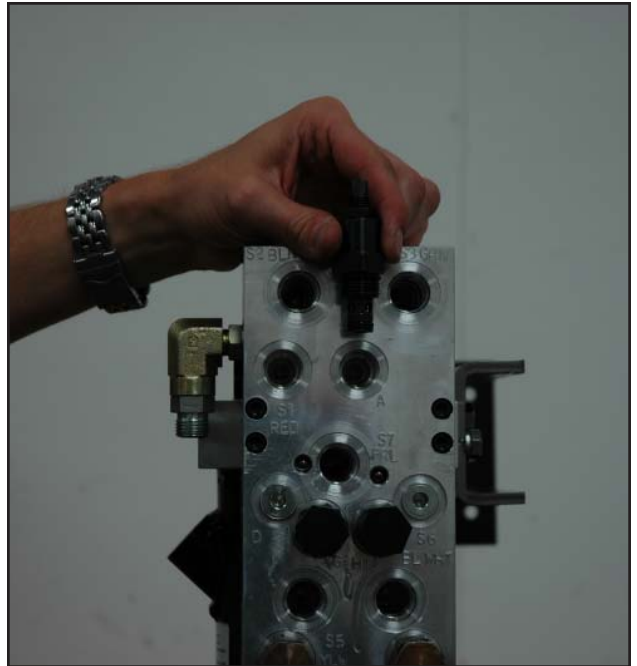

FIGURE 3-23

The lower adjustment assembly is removed. Clean by soaking in cleaning solvent.



FIGURE 3-24

Using a 7/8" wrench loosen and remove right side wing 3000 PSI relief valve assembly.

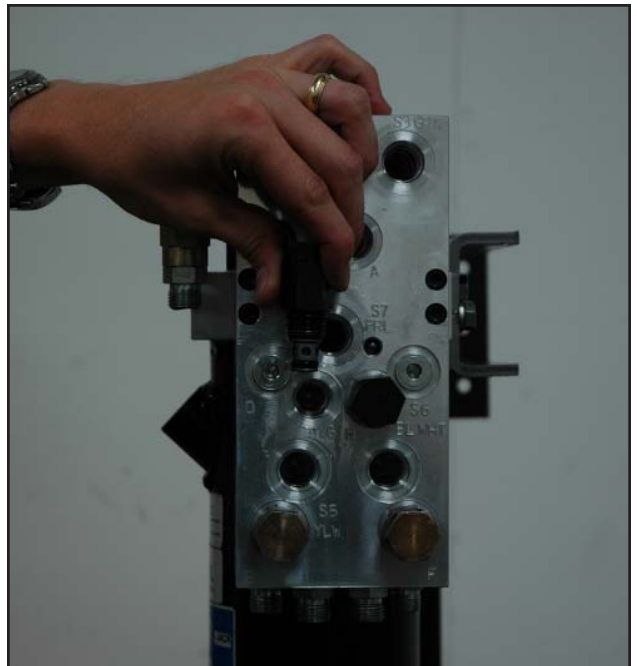

FIGURE 3-25

Right side wing 3000 PSI relief valve assembly is removed. Clean by soaking cartridge in cleaning solvent.

DISASSEMBLY - V-70



FIGURE 3-26

The Cap from the relief valve assembly can be removed with a 7/8" wrench. The pressure can be adjusted using a 1/4" allen wrench. Turn adjusting screw in to raise the pressure and turn out to lower pressure. Proper adjustment is 3000 PSI.

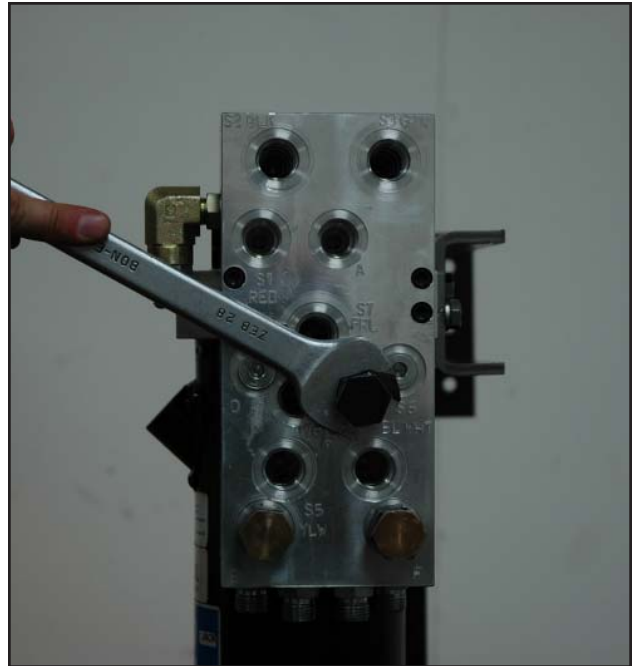

FIGURE 3-27

Using a 7/8" wrench loosen and remove left side wing 3000 PSI relief valve assembly.

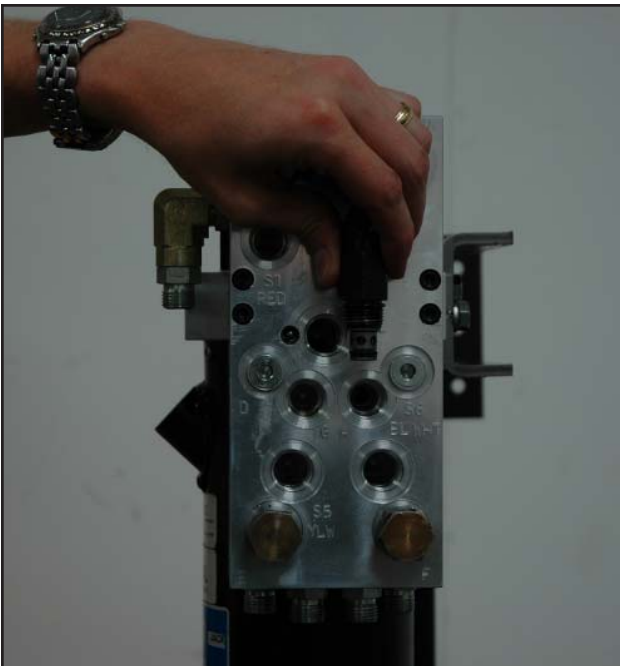

FIGURE 3-28

Left side wing 3000 PSI relief valve assembly is removed. Clean by soaking cartridge in cleaning solvent. See figure 3-31.

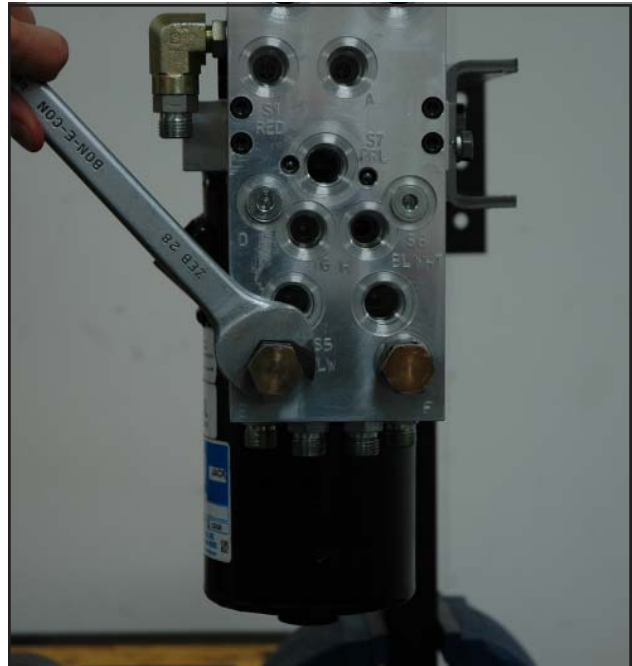

FIGURE 3-29

Using a 7/8" wrench loosen and remove right side wing 2900 PSI relief valve assembly.

DISASSEMBLY - V-70

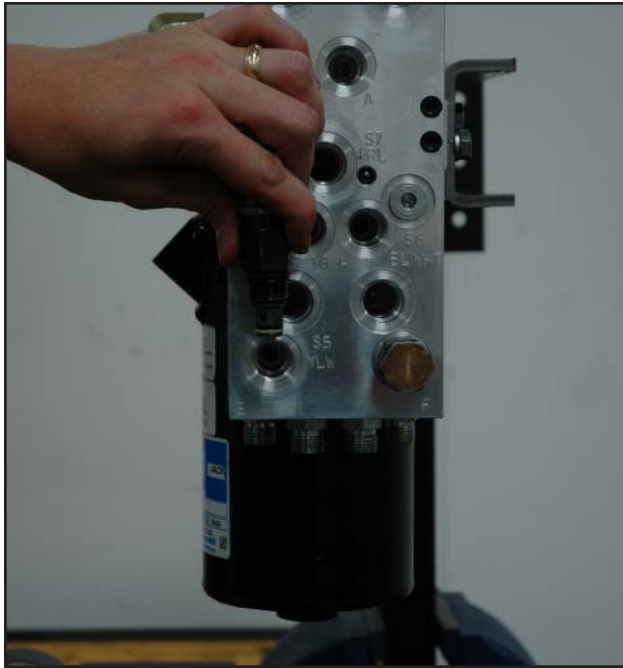

FIGURE 3-30

Right side wing 2900 PSI relief valve assembly is removed. Clean by soaking cartridge in cleaning solvent.



FIGURE 3-31

The Cap from the relief valve assembly can be removed with a 7/8" wrench. The pressure can be adjusted using a 1/4" allen wrench. Turn adjusting screw in to raise the pressure and turn out to lower pressure. Proper adjustment is 2900 PSI.

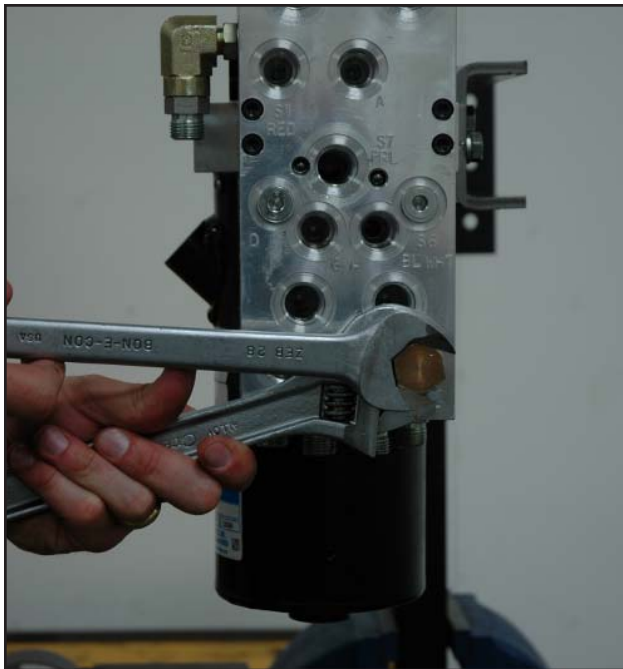

FIGURE 3-32

Using a 7/8" wrench loosen and remove left side wing 2900 PSI relief valve assembly.

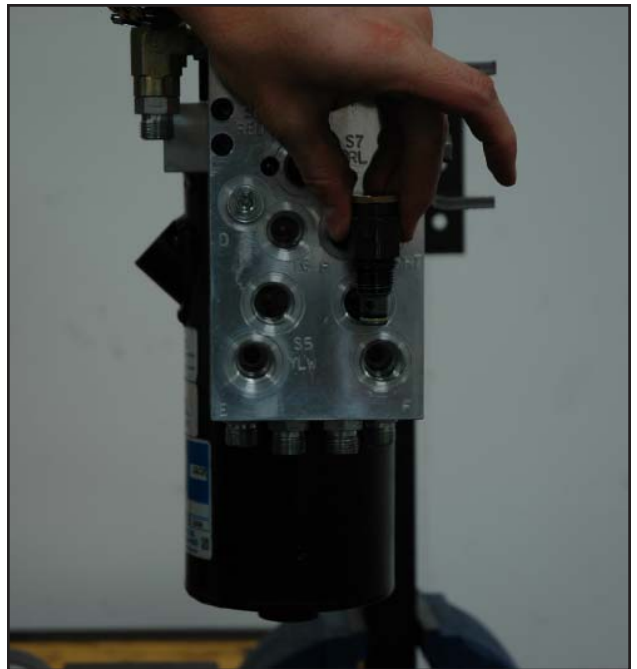

FIGURE 3-33

Left side wing 2900 PSI relief valve assembly is removed. Clean by soaking cartridge in cleaning solvent. See figure 3-36.

DISASSEMBLY - V-70

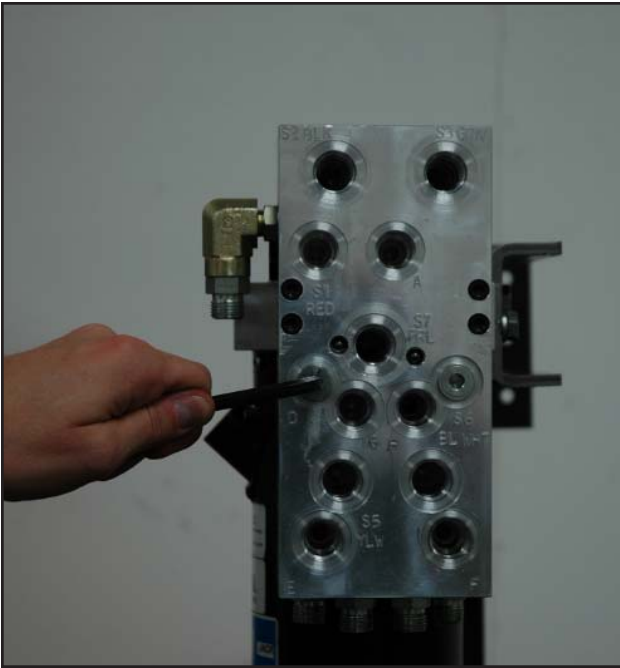

FIGURE 3-34

Use a 1/4" allen wrench to remove the cap for the right plow wing dual PO check valve.

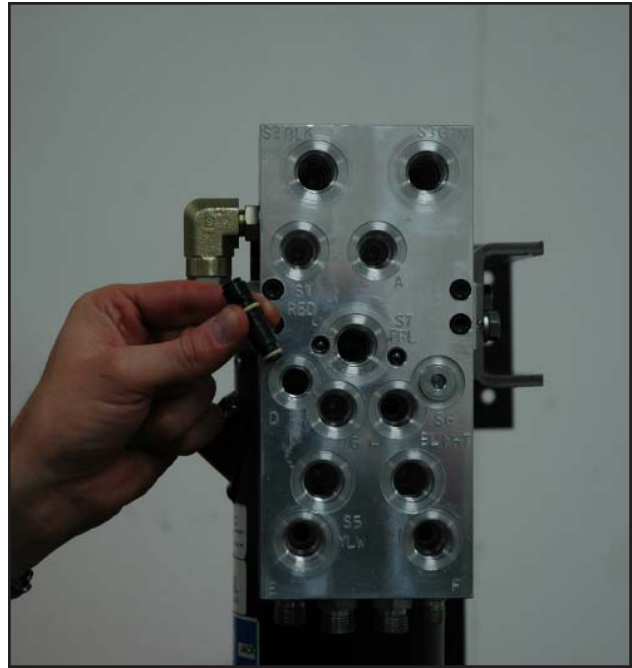

FIGURE 3-35

Using a small hook type tool pull out the right plow wing dual PO check valve cartridge. Clean by soaking cartridge in cleaning solvent.



FIGURE 3-36

Use a 1/4" allen wrench to remove the cap for the left plow wing dual PO check valve.

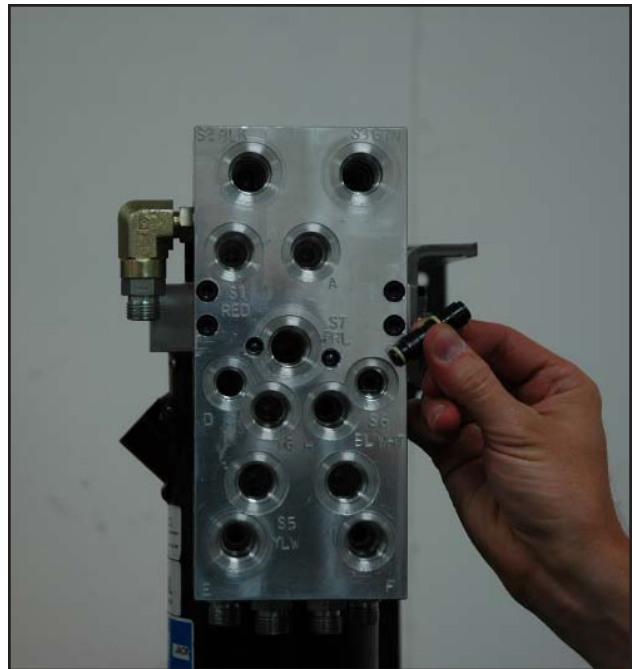

FIGURE 3-37

Using a small hook type tool pull out the left plow wing dual PO check valve cartridge. Clean by soaking cartridge in cleaning solvent.

DISASSEMBLY - V-70

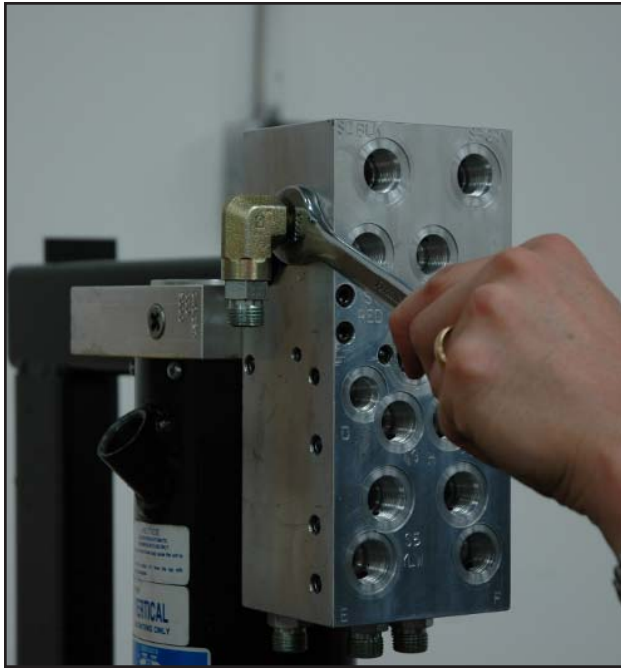

FIGURE 3-38

Use a 3/4" wrench to loosen sae elbow jam nut. Then remove sae elbow assembly.



FIGURE 3-39

Use a 7/8" wrench to loosen and remove the check valve assembly.

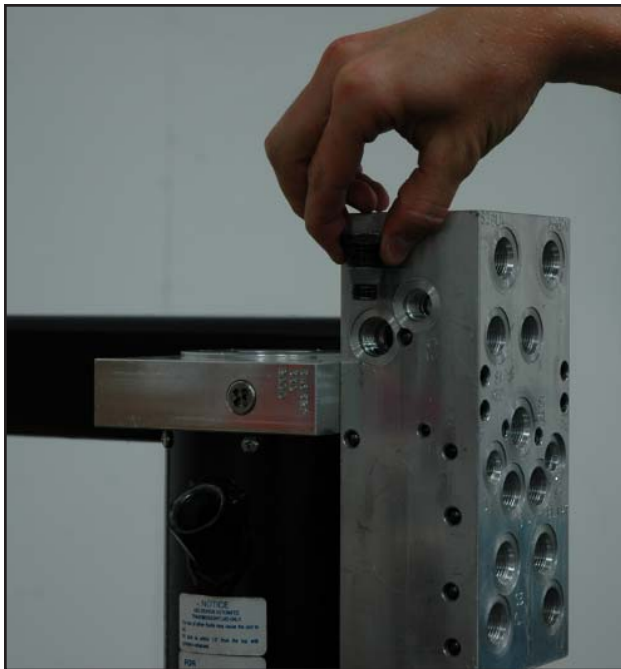

FIGURE 3-40

Check valve assembly is removed. Clean by soaking cartridge in cleaning solvent.



FIGURE 3-41

Use a needle nose pliers to remove the spring.

DISASSEMBLY - V-70



FIGURE 3-42

Use needle nose pliers to remove the dual acting piston.

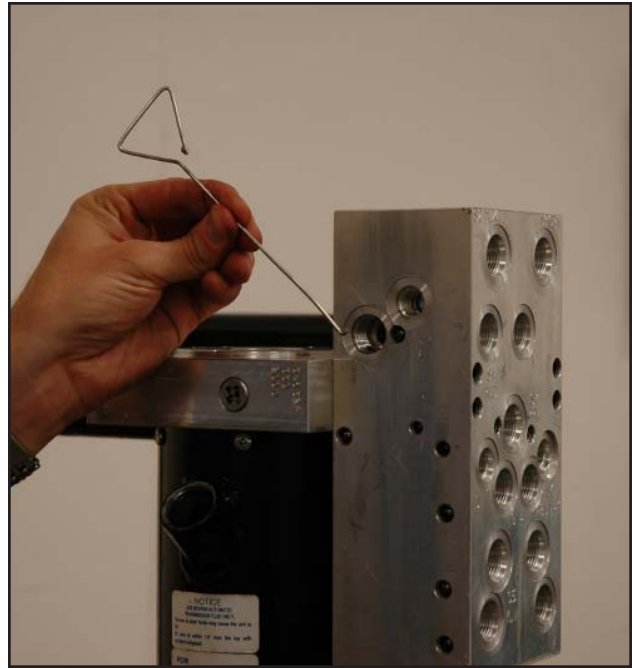

FIGURE 3-43

Use a hook type tool to reach in and remove the other spring.

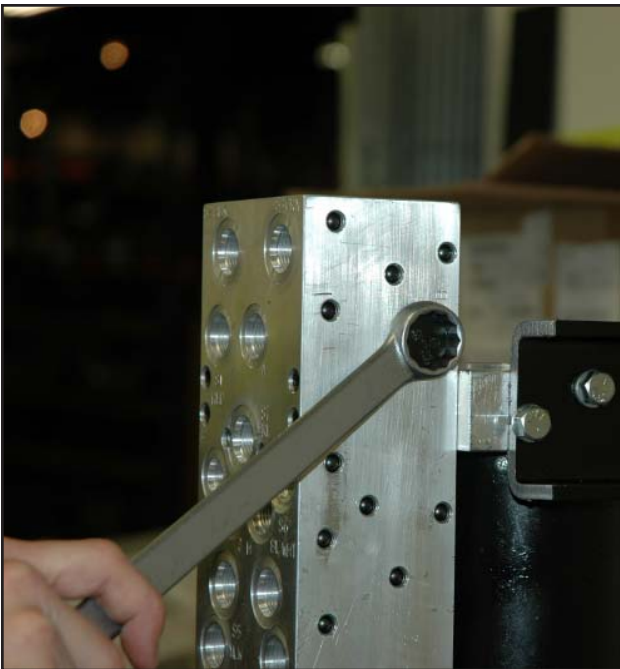

FIGURE 3-44

Use a 7/8" wrench to loosen and remove the check valve assembly.

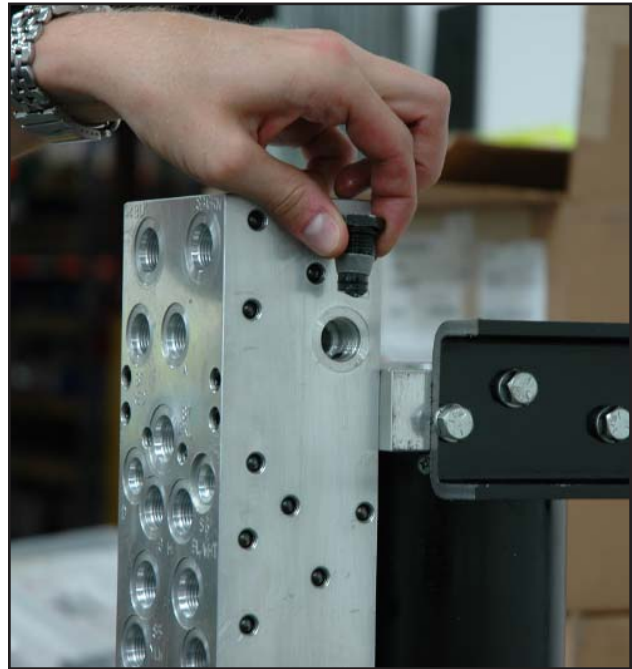

FIGURE 3-45

Use a 7/8" wrench to loosen and remove the check valve assembly. Clean by soaking cartridge in cleaning solvent.

DISASSEMBLY - V-70



FIGURE 3-46

Use a 7/16" wrench to remove the two bolts that fasten the motor to the base.



FIGURE 3-47

Carefully remove the motor from the base. Be sure to hold the rotor inside the stator.

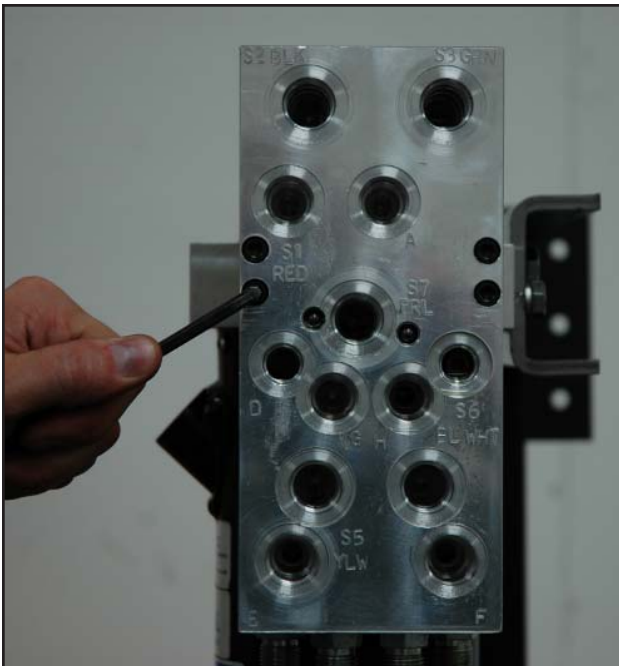

FIGURE 3-48

Use a 3/16" allen wrench to remove the four bolts that fasten the PA Block to the base.



FIGURE 3-49

Carefully remove the PA Block from the base. Clean by soaking PA Block in cleaning solvent.

DISASSEMBLY - V-70



FIGURE 3-50

Use a No. 2 phillips screwdriver to remove the screws which fasten the reservoir to the base.



FIGURE 3-51

Carefully remove the reservoir from the base. Clean reservoir in cleaning solvent.

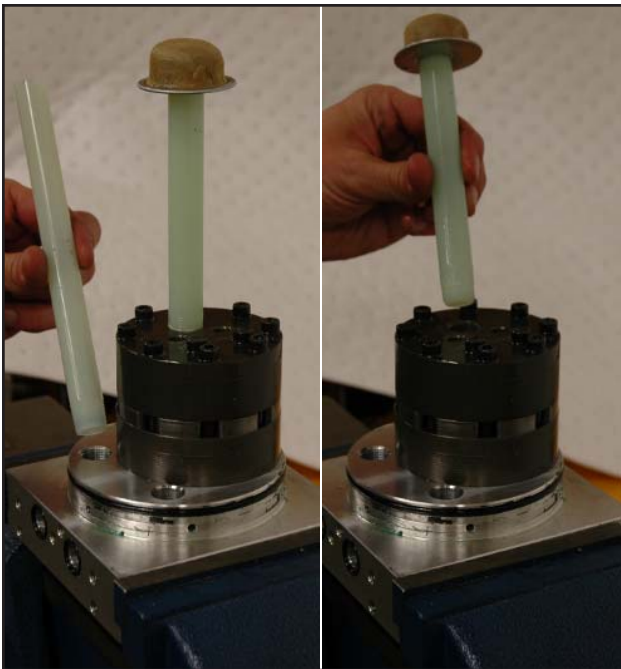

FIGURE 3-52

Carefully unscrew and remove return tube (left) and suction tube (right).



FIGURE 3-53

Pump filter assembly will slide off of the suction tube. Clean filter assembly in cleaning solvent.

DISASSEMBLY - V-70

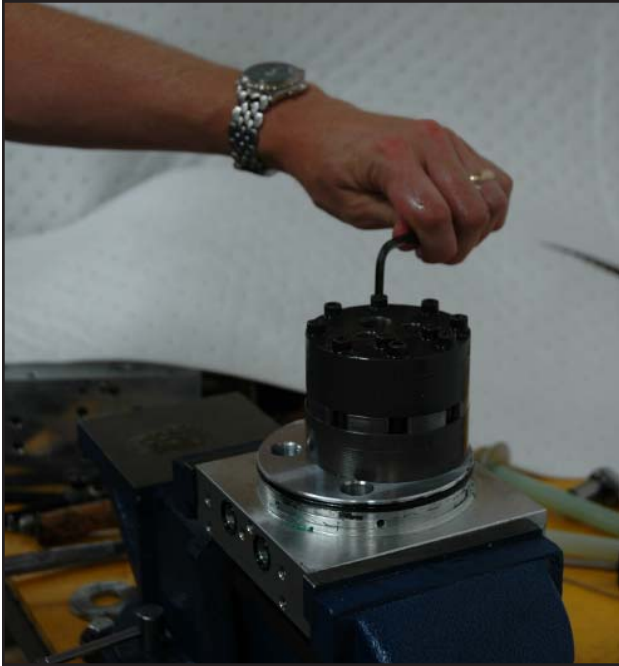

FIGURE 3-54

Use a 3/16" allen wrench to loosen and remove the four bolts which fasten the pump to the base.

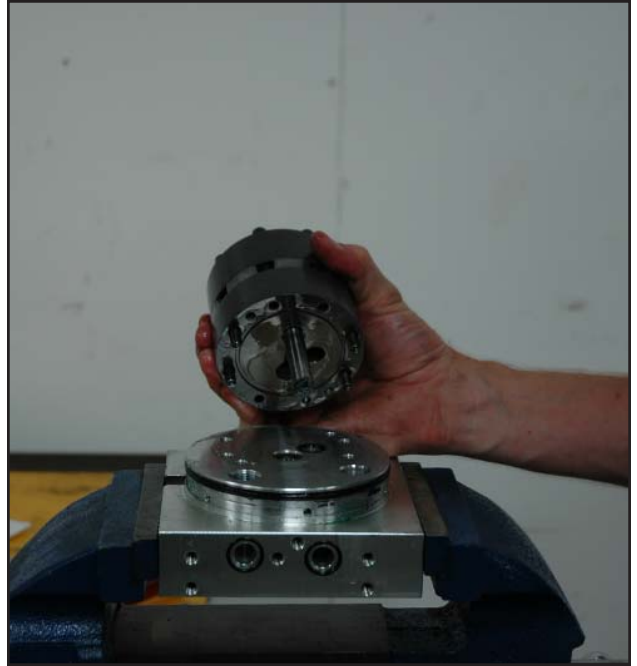

FIGURE 3-55

Remove the pump from the base. Clean pump in cleaning solvent.



FIGURE 3-56

Clean and inspect pump shaft seal. Replace if necessary.



FIGURE 3-57

Loosen jam nut and remove pump pressure adjustment screw. (2000 PSI set)

DISASSEMBLY - V-70



FIGURE 3-58
Remove pump pressure adjustment assembly.



FIGURE 3-59
Remove pump pressure adjustment spring.



FIGURE 3-60
Remove pump pressure adjustment ball.



FIGURE 3-61
Inspect base and clean base in cleaning solvent.

REASSEMBLY - V-70

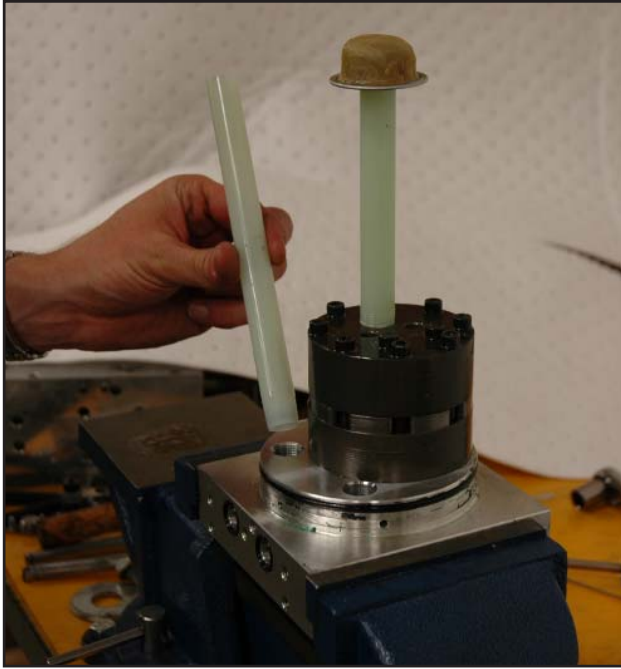

FIGURE 3-62

Install pump and torque the four 1/4-20 x 3" allen head bolts to 85-90 in. lbs. Thread intake tube and return filter into pump and sump base respectively.



FIGURE 3-63

Carefully install reservoir to sum base using five 12-24 x 3/8" self tapping screws.



FIGURE 3-64

Install pump pressure adjustment ball.



FIGURE 3-65

Install pump pressure adjustment spring.

REASSEMBLY - V-70



FIGURE 3-66

Install the pump pressure adjustment assembly screw. The adjustment is achieved by turning the screw clockwise to increase pump pressure and counter clockwise to decrease pump pressure. Proper adjustment is 2000 PSI.

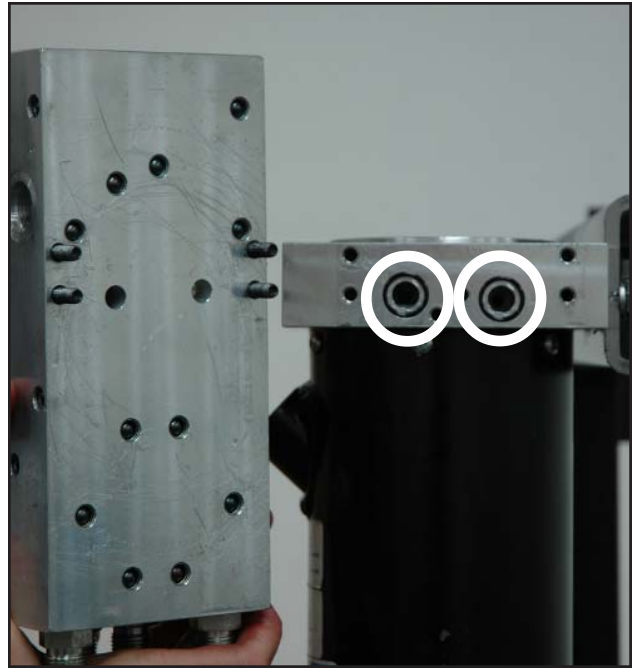

FIGURE 3-67

Replace the two o-rings and install the PA Valve Block Assembly to the Sump Base. Torqu the four 1/4-20 x 3-1/2" allen head bolts to 85-90 in. lbs.

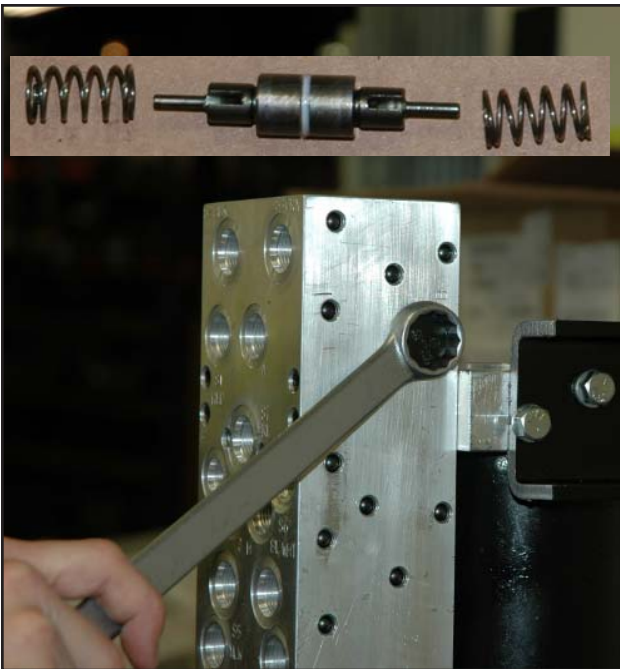

FIGURE 3-68

Install dual acting pilot piston with springs on either side into valve block. Then install the two PO check valves on either side using a 7/8" wrench.

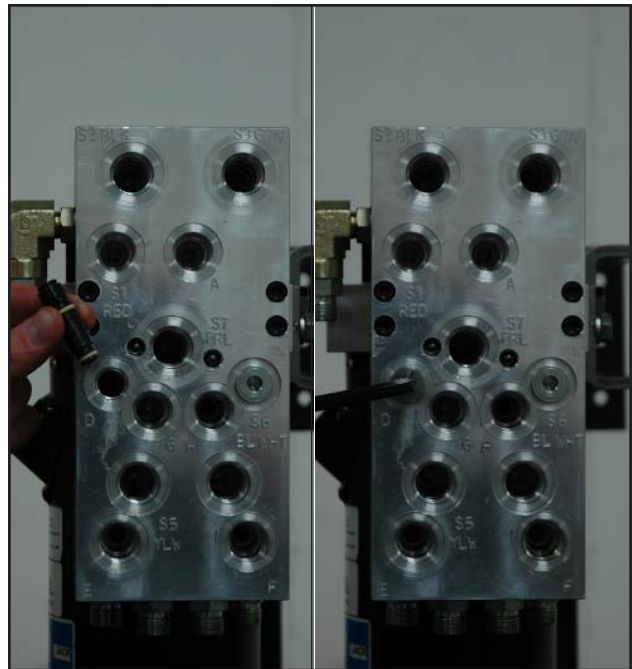

FIGURE 3-69

Install left and right dual PO check valves with caps using a 1/4" allen wrench.

REASSEMBLY - V-70

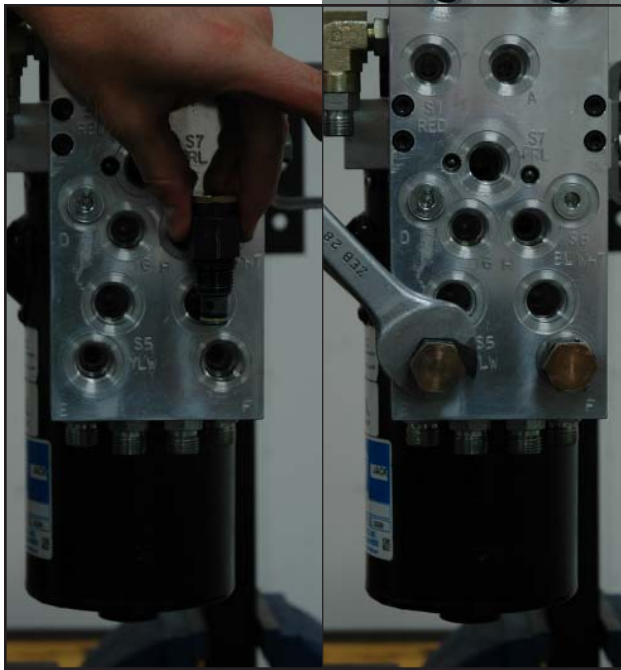

FIGURE 3-70

Install left and right 2900 PSI. relief valve assemblies and tighten using a 7/8" wrench.

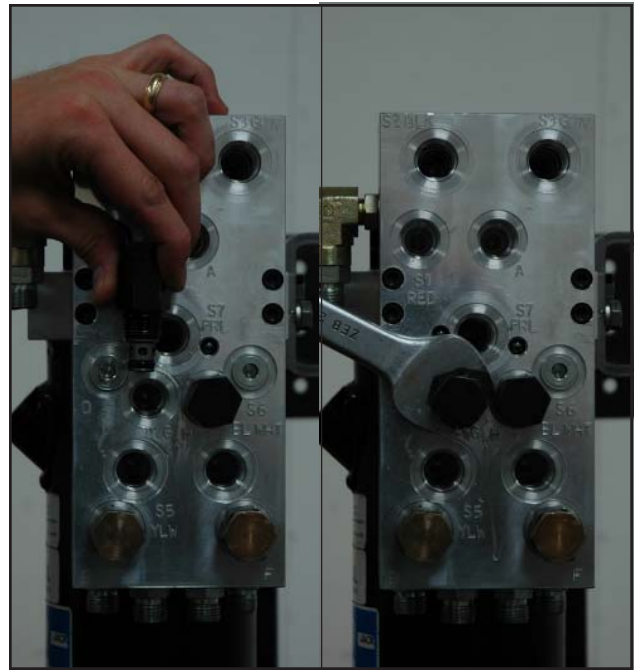

FIGURE 3-71

Install left and right 3000 PSI. relief valve assemblies and tighten using a 7/8" wrench.

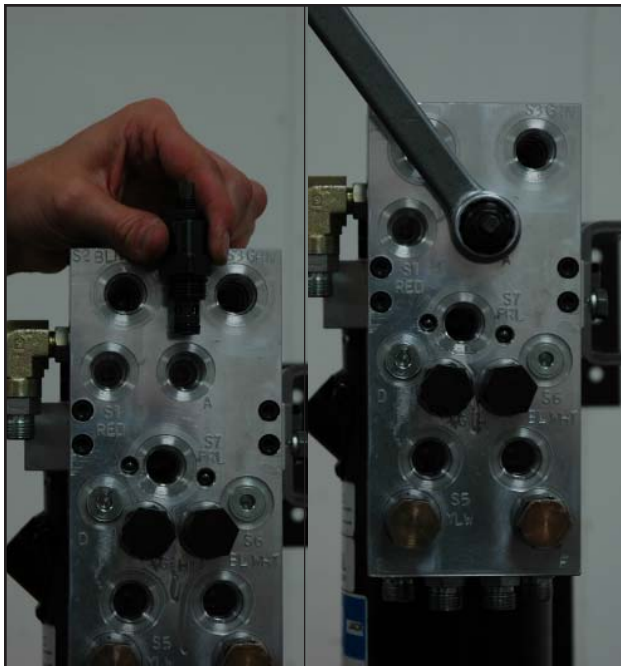

FIGURE 3-72

Install lower adjust assembly using a 7/8" wrench. Lower adjustment setting is achieved by loosening the jam nut and turn the adjustment screw clockwise to slow how fast the plow drops to the ground or turn the adjustment screw counter clockwise to make the plow drop faster.



FIGURE 3-73

Install all the solenoid valves into their proper location.

REASSEMBLY - V-70

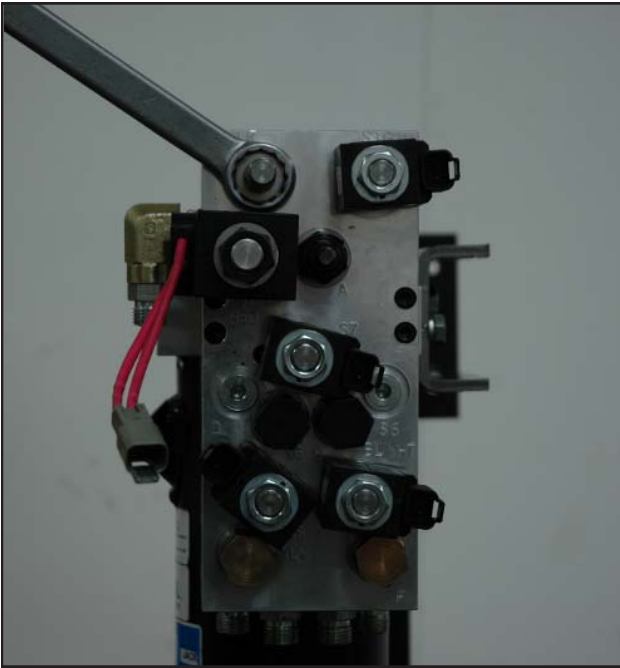

FIGURE 3-74

Tighten each solenoid valve using a 7/8" wrench.

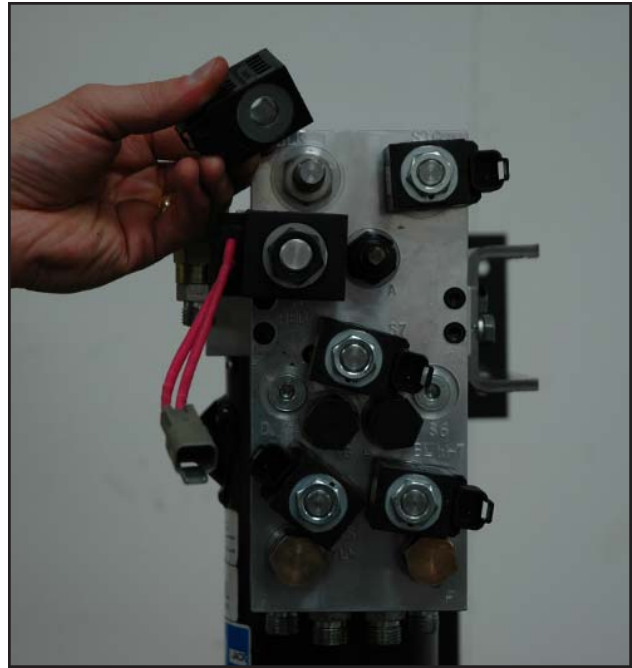

FIGURE 3-75

Install each coil to their respective locations on each solenoid valve.

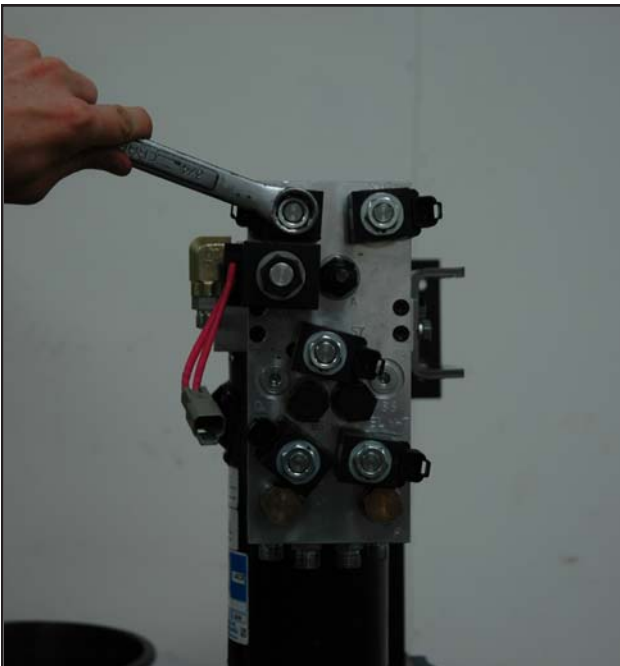

FIGURE 3-76

Tighten coil assembly nut to solenoid valve using a 3/4" wrench. (Do not overtighten)

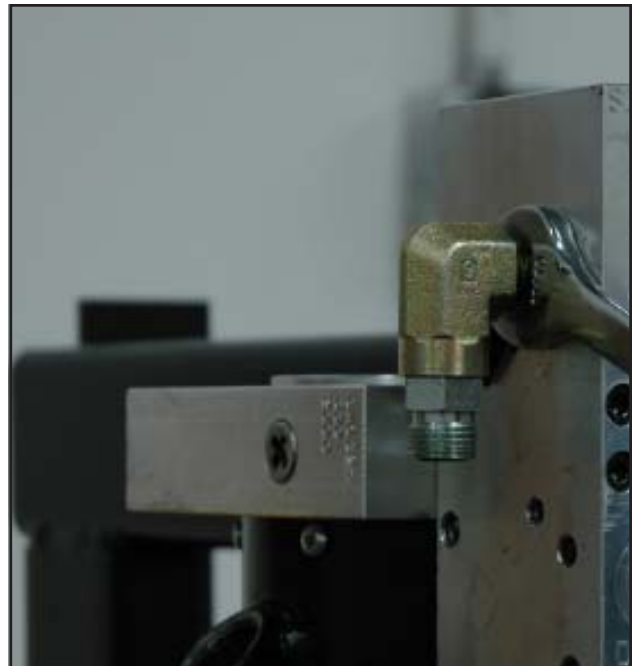

FIGURE 3-77

Install lift ram elbow assembly and tighten jam nut using a 3/4" wrench.

REASSEMBLY - V-70



FIGURE 3-78

Align pump shaft with motor shaft and carefully install motor to sump base. Tighten two motor screws using a 7/16" wrench.



FIGURE 3-79

Using a 1/4" allen wrench re-install and tighten reservoir drain plug.

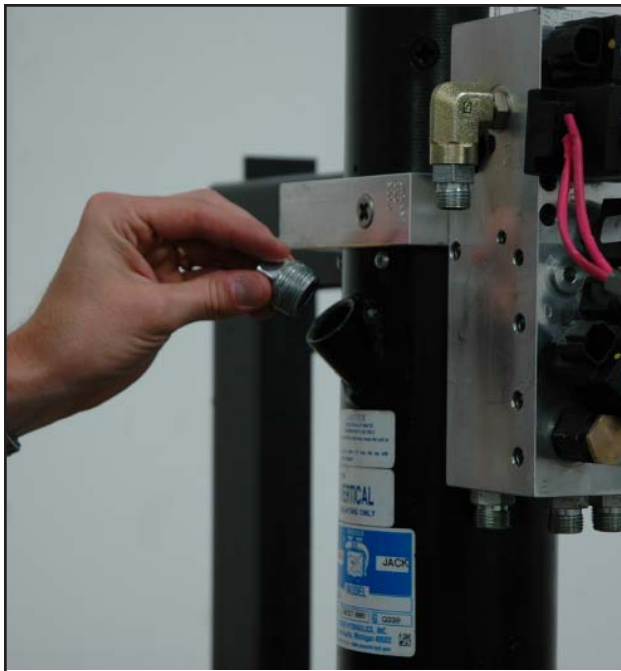

FIGURE 3-80

Remove reservoir fill plug.



FIGURE 3-81

Fill Hydraulic Unit with Meyer M-1 Fluid. Proper fluid level is just below the neck of the filler hole. It must be checked with the Lift Ram and both wing cylinders fully retracted.

HYDRAULIC SPECIFICATIONS

ELECTRICAL SPECIFICATIONS

MOTOR

Under load (pump operating in relief)

NOTE: Do not operate motor continuously for more than 5 seconds.

Applied Voltage	12 Volts DC
Max. Current Draw	250 Amperes

SOLENOID VALVES "S1", "S2", "S3", "S5", "S6" & "S7"

Applied Voltage	12 Volts DC
Current Draw	1.9 Amperes

Nominal resistance (ohm meter lead connected to coil lead) 8.0 ohms \pm 10%.

MOTOR SOLENOID

Applied Voltage	12 Volts DC
Max. Current Draw	5 Amperes

Nominal resistance (ohm meter lead connected to coil lead, other meter lead connected to metal foot) 2.65 to 4.5 ohms.

PUMP - Pressure Output

V-70 (Non Adjustable)	2000 P.S.I.
-----------------------	-------------

CROSSOVER RELIEF VALVE

Opening Pressure	2000 P.S.I.
------------------	-------------

HYDRAULIC FLUID CAPACITY

NOTE :1 Quart = 32 Fluid Ounces

Model V-70

Unit	1.55 qt., 0 oz.	(50 oz.)
Hoses, Lift Cylinder & D.A.	19 oz.	
Total	2 qt., 5 oz.	(69 oz.)

V-70 power unit service manual



Meyer Products LLC
18513 Euclid Ave. • Cleveland, Ohio 44112-1084
Phone 486-1313 (Area Code 216)
www.meyerproducts.com • email info@meyerproducts.com