

E-58H, E-68, E-78 & E-88 power unit service manual

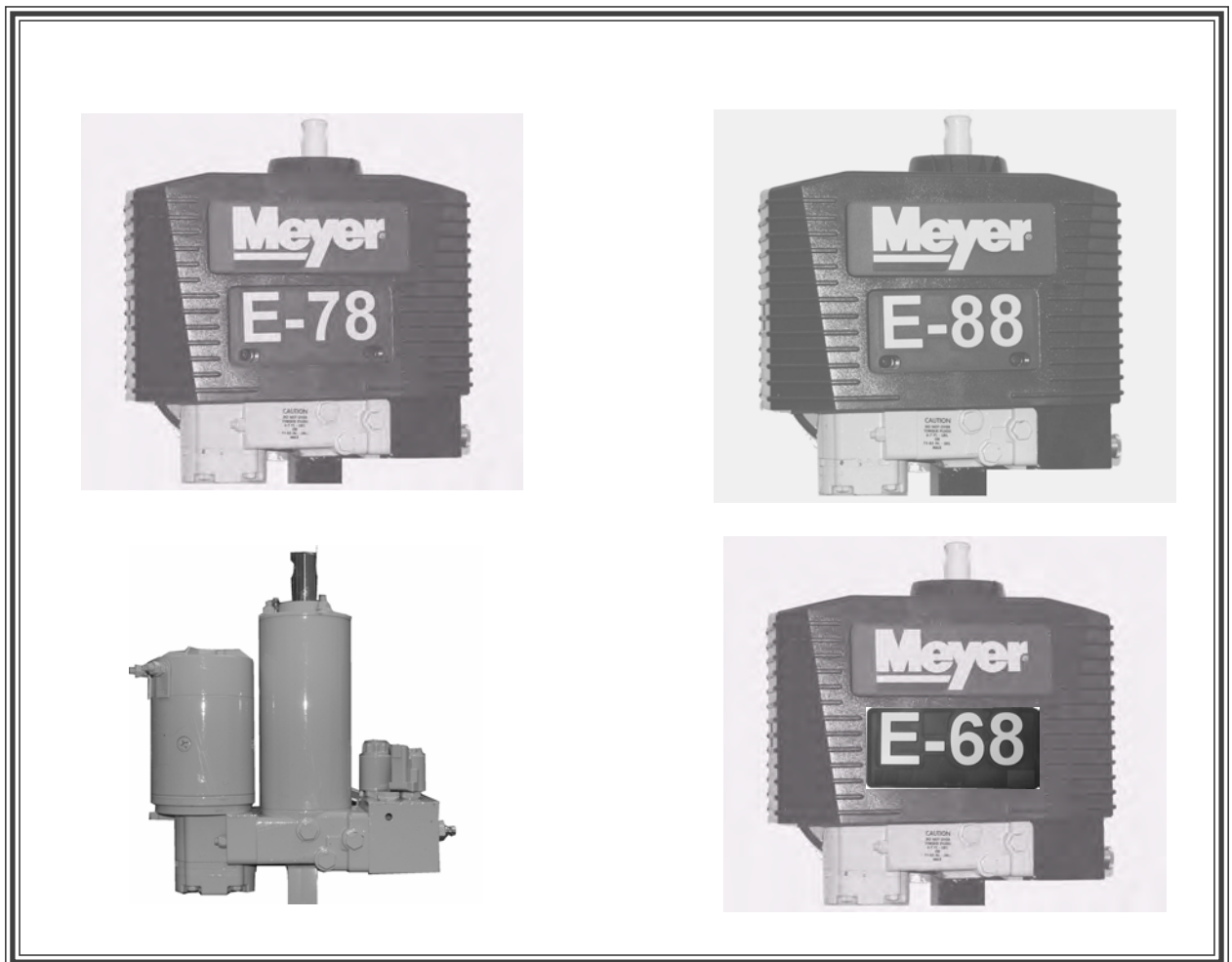

Meyer Products LLC
18513 Euclid Ave. • Cleveland, Ohio 44112-1084
Phone 486-1313 (Area Code 216)
www.meyerproducts.com • email info@meyerproducts.com

Meyer Products LLC
6 Angell Lane • Damariscotta, ME 04543-4507
Phone 563-2227 (Area Code 207)
www.meyerproducts.com • email info@meyerproducts.com

FOREWARD

This Service Manual includes complete information for servicing the following Electro Lift® Units:

E-58H

E-78 E-Z Mount Plus

E-68 E-Z Mount Xpress

E-88 E-Z Mount Xpress

IMPORTANT: Maintenance and repairs must be performed with the moldboard on the ground.

The information is grouped according to the type of work being performed, such as diagnosis and testing, disassembly and reassembly. Special tools and specifications are also included in this manual.

All information, illustrations and product descriptions contained in this manual are correct at publication time. We do, however, reserve the right to make changes at any time without prior notice.

MEYER PRODUCTS INC.

SECTION INDEX

Section Number	Section Title	Page
0	GENERAL INFORMATION AND MAINTENANCE	1
1	GENERAL DESCRIPTION AND THEORY OF OPERATION	4
2	DIAGNOSIS	19
3	REPAIR PROCEDURE	36
4	ELECTRONIC TROUBLESHOOTING	70
5	SPECIFICATIONS	75

SECTION 0 - GENERAL INFORMATION AND MAINTENANCE

CONTENTS

- GENERAL INFORMATION 2
 - MODEL IDENTIFICATION 2
 - MODEL IDENTIFICATION AND SERIAL NUMBER LOCATION 2
 - MOTOR IDENTIFICATION 2
- MAINTENANCE 2
 - GENERAL MAINTENANCE 2
 - CLEANLINESS 2
 - VEHICLE ELECTRICAL SYSTEM 2
 - CHECK REGULARLY 2
- POST-SEASON MAINTENANCE 2
 - MEYER HYDRAULIC FLUID M-1 2
 - REPLACEMENT OF HYDRAULIC FLUID 3
 - FILTERS 3
 - PROTECTION AGAINST RUST AND CORROSION 3

GENERAL INFORMATION

Model Identification

The E-58H, E-68, E-78 & E-88 unit is an electrically powered hydraulic mechanism specifically designed for use with the Meyer E-Z Mount Xpress and E-Z Mount Plus and E-Z Mount Classic Snow Plow systems.

Model Identification and Serial Number Location

Inclusion of the model number and serial number is extremely important when writing up warranty claim forms and product report forms for proper evaluation and follow up.

The basic model number is located on the name plate (plastic cover). The serial number is located on the name plate decal underneath the plastic cover.

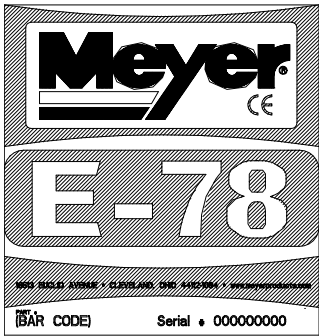
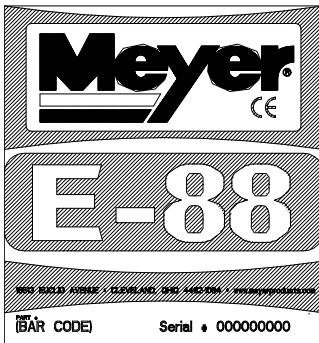

MAINTENANCE

The following maintenance information is intended as a basic guide for providing the E-58H, E-68, E-78 & E-88 unit with the proper service and care. Sustained heavy duty operation or operating under adverse conditions may necessitate more frequent servicing.

General Maintenance

Cleanliness

The greatest enemy to any hydraulic system is dirt or contamination. Therefore, cleanliness must be stressed at the time of installation, servicing and repairing.

Vehicle Electrical System

Maximum performance and efficiency of the Electro Lift® unit requires that the vehicle's electrical system be properly maintained and consist of:

Battery -----	70 Amp. Hr. Minimum or 550 Cold Cranking Amps.
Alternator -----	60 Amp. Minimum

Check Regularly

1. Battery Terminals - Must be clean and free of corrosion.
2. Electrical Connections - Must be free of corrosion and tight.
3. Battery - Must be in first-class condition.
4. Alternator (or Generator) and Regulator - Must be functioning to specifications.
5. Hydraulic Fluid Reservoir Level - A significant drop in hydraulic fluid level indicates a leak which must be located and corrected. Insufficient hydraulic fluid may result in severe damage.

POST-SEASON MAINTENANCE

Meyer Hydraulic Fluid M-1.

Meyer Hydraulic Fluid M-1 is a specially formulated mineral oil which maintains an almost constant viscosity from normal to sub-zero temperatures. Because it remains free flowing at extremely low temperatures, the performance and efficiency are not affected.

Meyer Hydraulic Fluid M-1 also contains an additive which neutralizes moisture accumulating in the fluid due to condensation. It is effective for a maximum of one year's use.

Meyer Products Inc. will not be liable for damages resulting from the use of inferior or other fluids or oils.

FIGURE 0-1 E-68 & E-88

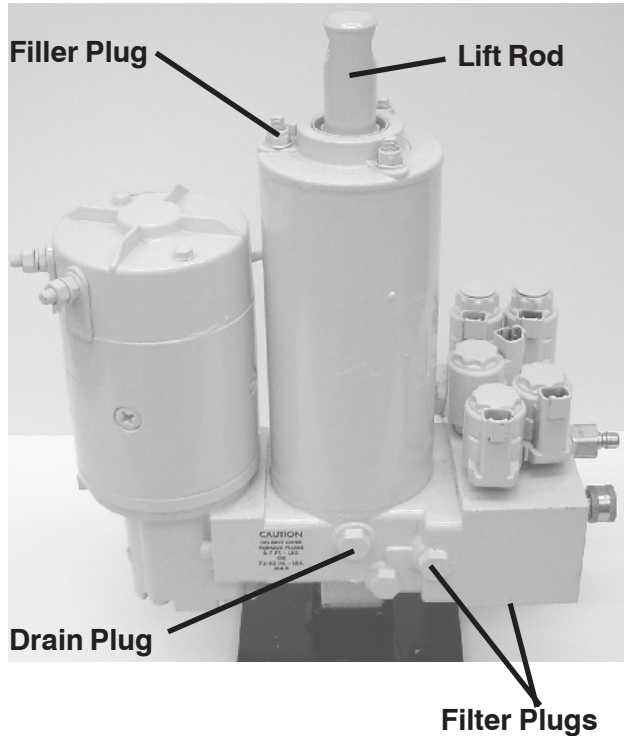

Replacement of Hydraulic Fluid

After a season's use, completely drain the hydraulic fluid (including hydraulic fluid in hoses and cylinders). Drain fluid through filler hole shown in Figure 0-1 or drain hole in base by completely retracting lift rod and unbolting unit to pour fluid out or using a suction pump. Disconnect the fittings at the Angling and Mount (E-88 only) cylinders and completely retract the cylinder rods and purge cylinders and hoses of all hydraulic fluid. Flush the complete system including unit, hoses and angling rams with the M-2 Flushing Fluid, or a non wax (Naphthenic) cleaner. If kerosene (Paraffinic) is used to flush the system, the system must be flushed again to remove any kerosene with M-2 Flushing Fluid, or a (Naphthenic) based cleaner that is wax free .

Refill E-58H, E-68, E-78 & E-88 unit with M-1 Fluid by fully retracting lift rod (Ram) and filling reservoir to 1-1/2 " below the filler hole. Fill and bleed hoses and Power Angling and Mount (E-68 & E-88 only) cylinders by loosening hydraulic fittings at cylinders until they leak. Power angle plow repeatedly from one side to the other until fluid flows steadily from the leaking fittings while maintaining a constant check on the reservoir fluid level. Repeat for mounting (E-68 & E-88 only) cylinder.

Raise and lower the plow several times and with lift rod fully retracted, give a final check to the fluid level and replace filler plug.

Filters

Clean the two filters located in base of unit and power angling block with mineral spirits or equivalent and blow out with compressed air. See Figure 0-1 for filter locations.

Protection Against Rust and Corrosion

When the E-58H, E-68, E-78 & E-88 unit is not used for extended periods, protect the chromed lift rod (Ram) by fully extending it and coating it with chassis lubricant. Full extension of the lift rod (Ram) fills the cylinder with hydraulic fluid. Coat the exposed portions of the Power Angling cylinder rods (Rams) and Mount cylinder (E-68 & E-88 only) of the E-Z Mount Xpress with chassis lubricant to protect them against rust and corrosion.

FIGURE 0-1 E-58H & E-78

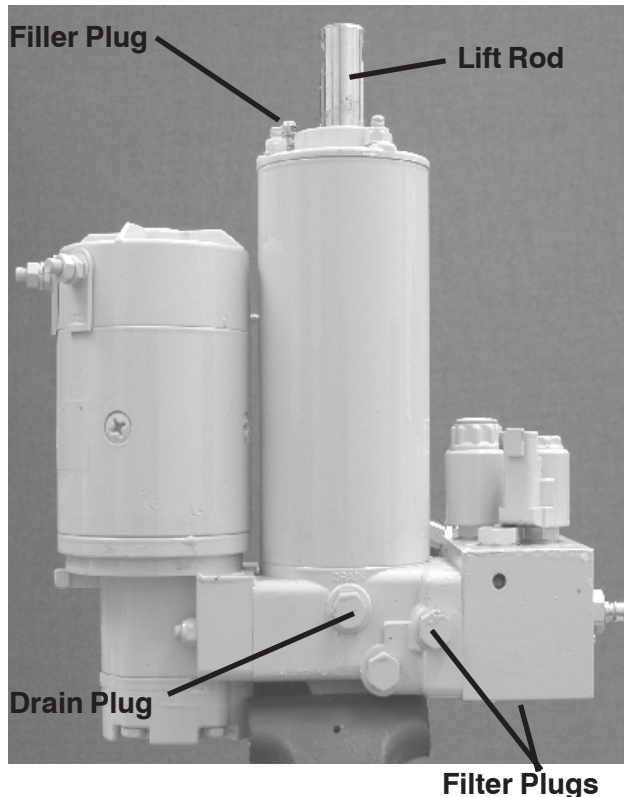

SECTION 1 - GENERAL DESCRIPTION AND THEORY OF OPERATION

CONTENTS

GENERAL DESCRIPTION	5
THEORY OF OPERATION	5
• FUNCTIONS E-58H, E-68, E-78 & E-88	5
• ELECTRICAL AND FLOW CHARTS	6-15
•• E-68 & E-88	6-11
•• E-78	12-15
•• E-58H	31-35
ELECTRO LIFT® UNIT COMPONENTS	16
• MOTORS	16
•• Iskra	16
• HYDRAULIC PUMP	16
• PRESSURE RELIEF VALVE	16
• SOLENOID VALVES	16-17
•• Cartridge	16
•• Coil	17
“A” Solenoid Valve	17
“B” Solenoid Valve	17
“C” Solenoid Valve	17
“D” Solenoid Valve (E-68 & E-88 only)	17
“E” Solenoid Valve (E-68 & E-88 only)	17
• CHECK VALVES	18
• PILOT CHECK VALVE	18
• CROSSOVER RELIEF VALVES	18
• SOLENOID SWITCH	18
• FILTERS	18

GENERAL DESCRIPTION

E-58H, E-68, E-78 & E-88 unit is an electrically powered and electrically controlled hydraulic mechanism specifically designed for use with Meyer Snow Plows. The E-58H, E-68, E-78 and E-88 raises and lowers the plow with an integral 8" stroke hydraulic cylinder. The E-68 & E-88 will also mount and dismount the Xpress plow system from the vehicle using a hydraulic Mount/Dismount Cylinder.

In addition to raising and lowering the plow hydraulically, the E-58H, E-68, E-78 & E-88 angles the plow hydraulically, left and right, via remote hydraulic cylinders.

The Electro Lift® unit consists of a specially designed high torque 12-volt DC motor which is directly coupled to a gear-type hydraulic pump. The pump obtains its supply of hydraulic fluid from an integral reservoir which totally surrounds the integral hydraulic cylinder which raises and lowers the plow.

The E-68 & E-88 includes an integral valve body which contains five electrically controlled solenoid valve cartridges. Solenoid valve cartridge "A" which is energized to allow the plow to lower by gravity. Solenoid valve cartridge "B" is energized to route the pressurized hydraulic fluid to the integral hydraulic cylinder to raise the plow. Solenoid valve cartridge "C" is energized to route the pressurized hydraulic fluid to the left remote hydraulic cylinder to angle the plow to the right. Solenoid valve cartridge "D" is energized to route the pressurized hydraulic fluid to the right remote hydraulic cylinder to angle the plow to the left. Solenoid valve cartridge "E" is energized to route the pressurized hydraulic fluid to extend the mount/dismount hydraulic cylinder to remove the plow from the vehicle. Mounting the plow to the vehicle only requires energizing the electric motor since the normal route for the pressurized hydraulic fluid is to retract the mount hydraulic cylinder.

The E-58H & E-78 includes an integral valve body which contains three electrically controlled solenoid valve cartridges. Solenoid valve cartridge "A" which is energized to allow the plow to lower by gravity. Solenoid valve cartridge "B" is energized to route the pressurized hydraulic fluid to the integral hydraulic cylinder to raise the plow. Solenoid valve cartridge "C" is energized to route the pressurized hydraulic fluid to the left remote hydraulic cylinder to angle the plow to the right. When all cartridge are not energized and the motor is running the pressurized hydraulic fluid will flow to the right remote hydraulic cylinder to angle the plow to the left.

Additional components which control and supply electrical current to the E-58H, E-68, E-78 & E-88 units are an operator controlled Touchpad (E-58H & E-68 only), RCM (Remote Control Module); a solenoid switch to supply high amperage current to the unit's motor (motor solenoid); a PCM (Plow Control Module) (E-78 & E-88 only) and a HCM (Headlight Control Module)(E-78 & E-88 only). valve cartridge(s); and short heavy gauge cables to distribute high amperage current directly from the positive terminal of the vehicle's battery and ground the unit directly to the negative terminal of the vehicle's battery.

THEORY OF OPERATION

FUNCTIONS

The E-68 & E-88's six basic functions performed are:

- Raise snow plow
- Lower snow plow
- Angle snow plow to right
- Angle snow plow to left
- Mount Xpress Snow Plow System
- Dis-mount Xpress Snow Plow System

Refer to Figures 1-1 through 1-6 (pages 6 thru 11) for electrical and hydraulic flow chart for each function. Each figure explains which component is actuated and related in each function.

The E-58H & E-78's four basic functions performed are:

- Raise snow plow
- Lower snow plow
- Angle snow plow to right
- Angle snow plow to left

Refer to Figures 1-7 through 1-10 (pages 12 thru 15) for electrical and hydraulic flow chart for each function. Each figure explains which component is actuated and related in each function.

E-68 & E-88 Mount, Motor Only

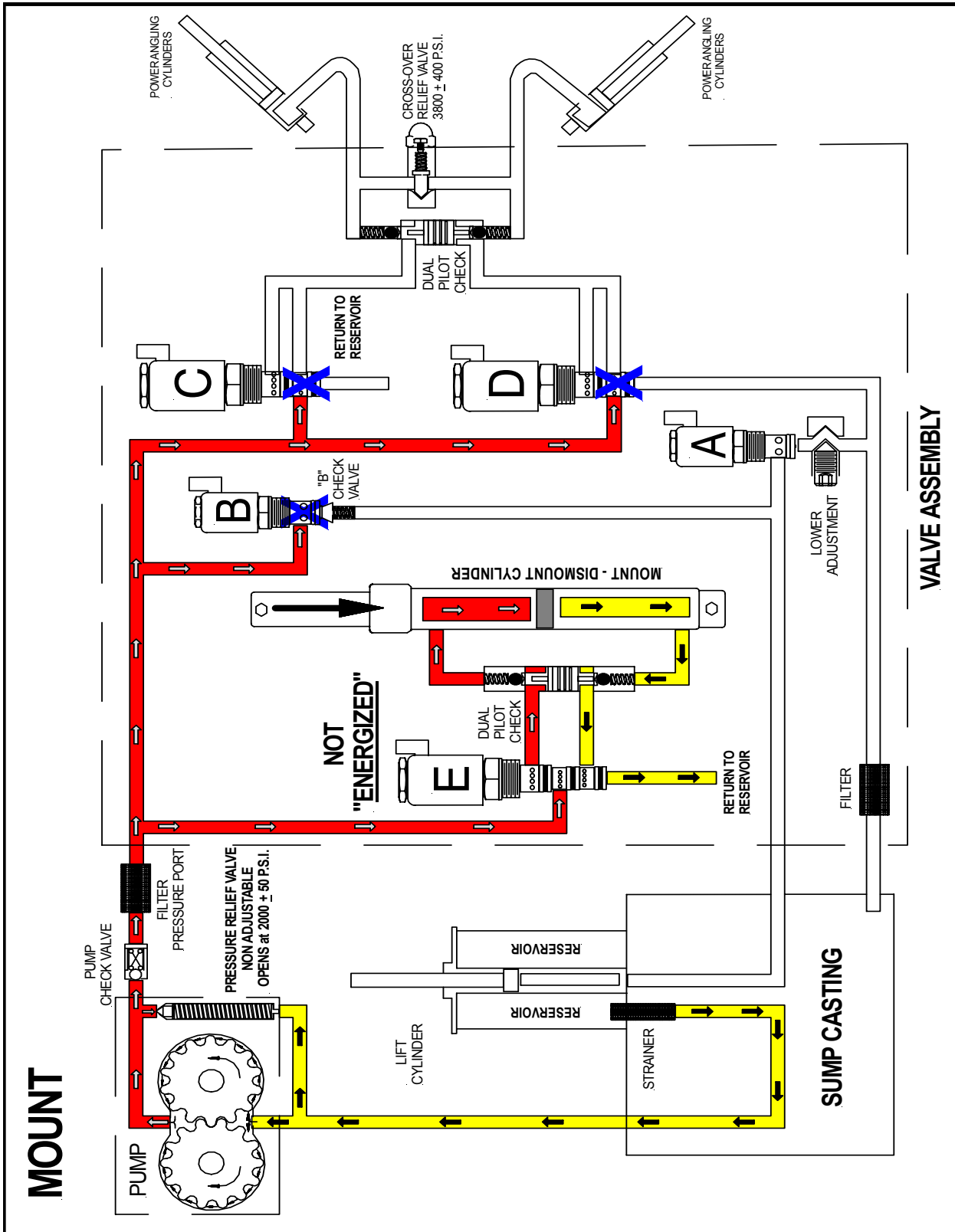

FIGURE 1-1

E-68 & E-88 Dismount, Motor and "E" Solenoid

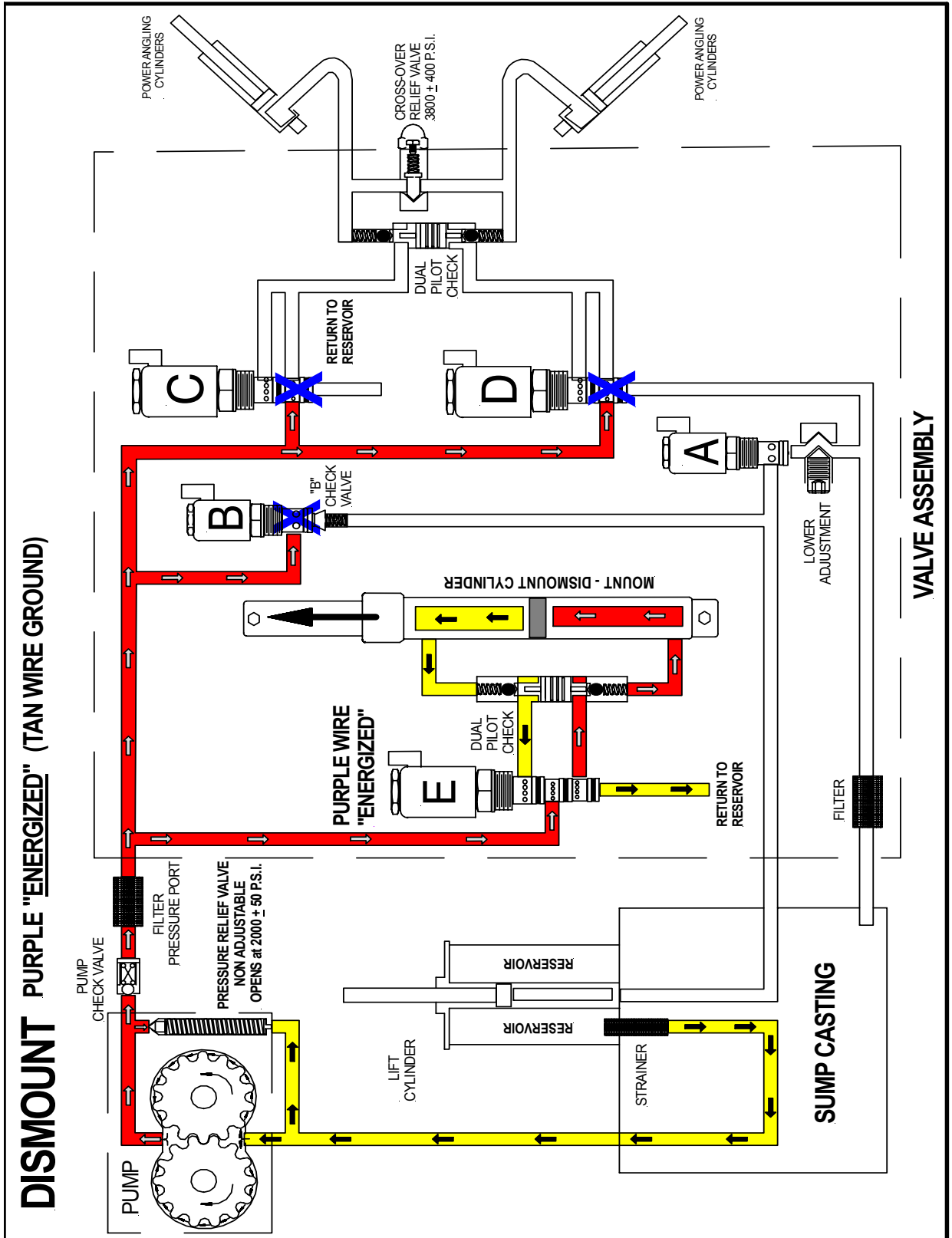

FIGURE 1-2

E-68 & E-88 Raise, Motor and "B" Solenoid

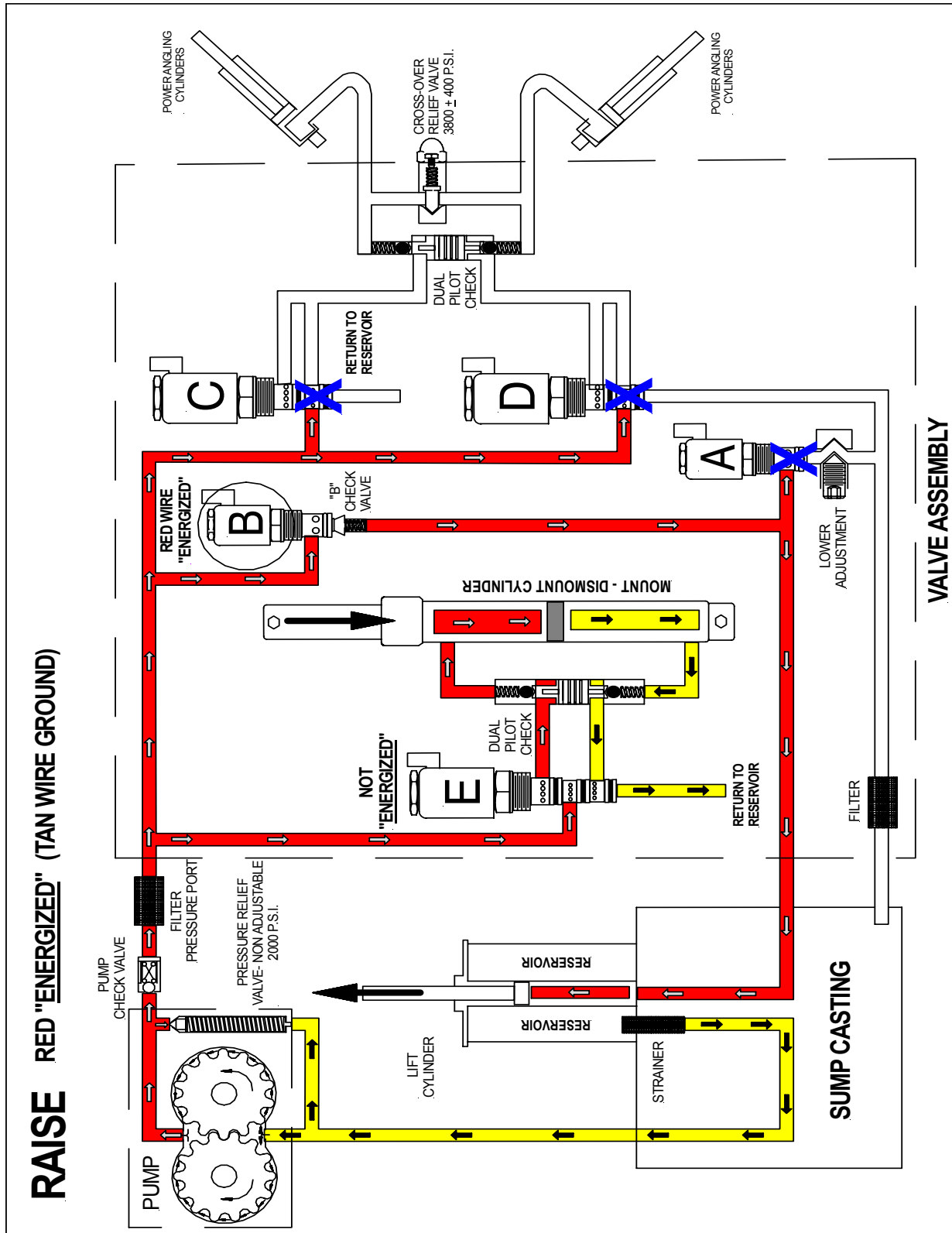

FIGURE 1-3

E-68 & E-88 Lower, "A" Solenoid

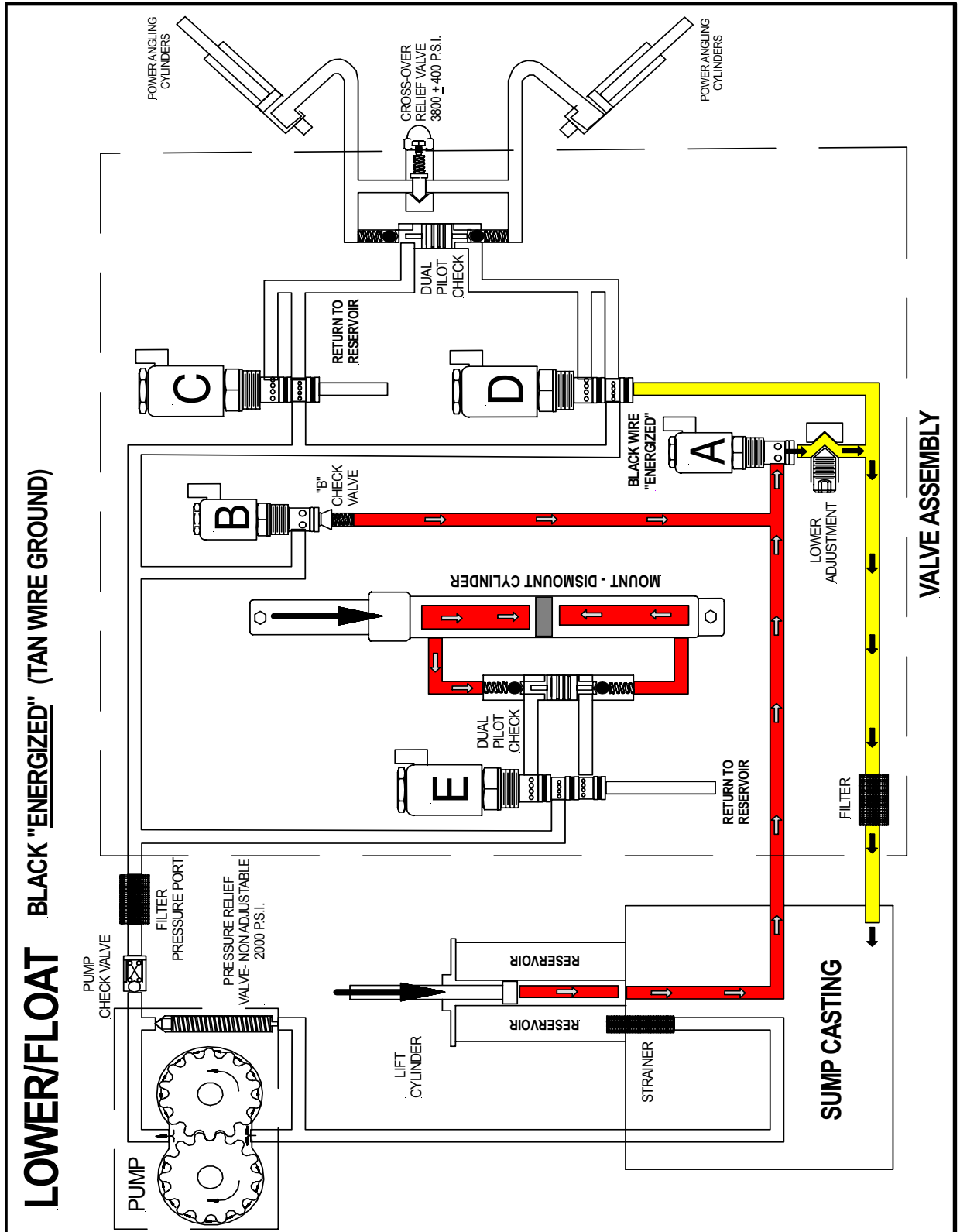

FIGURE 1-4

E-68 & E-88 Angle Left, Motor and "D" Solenoid

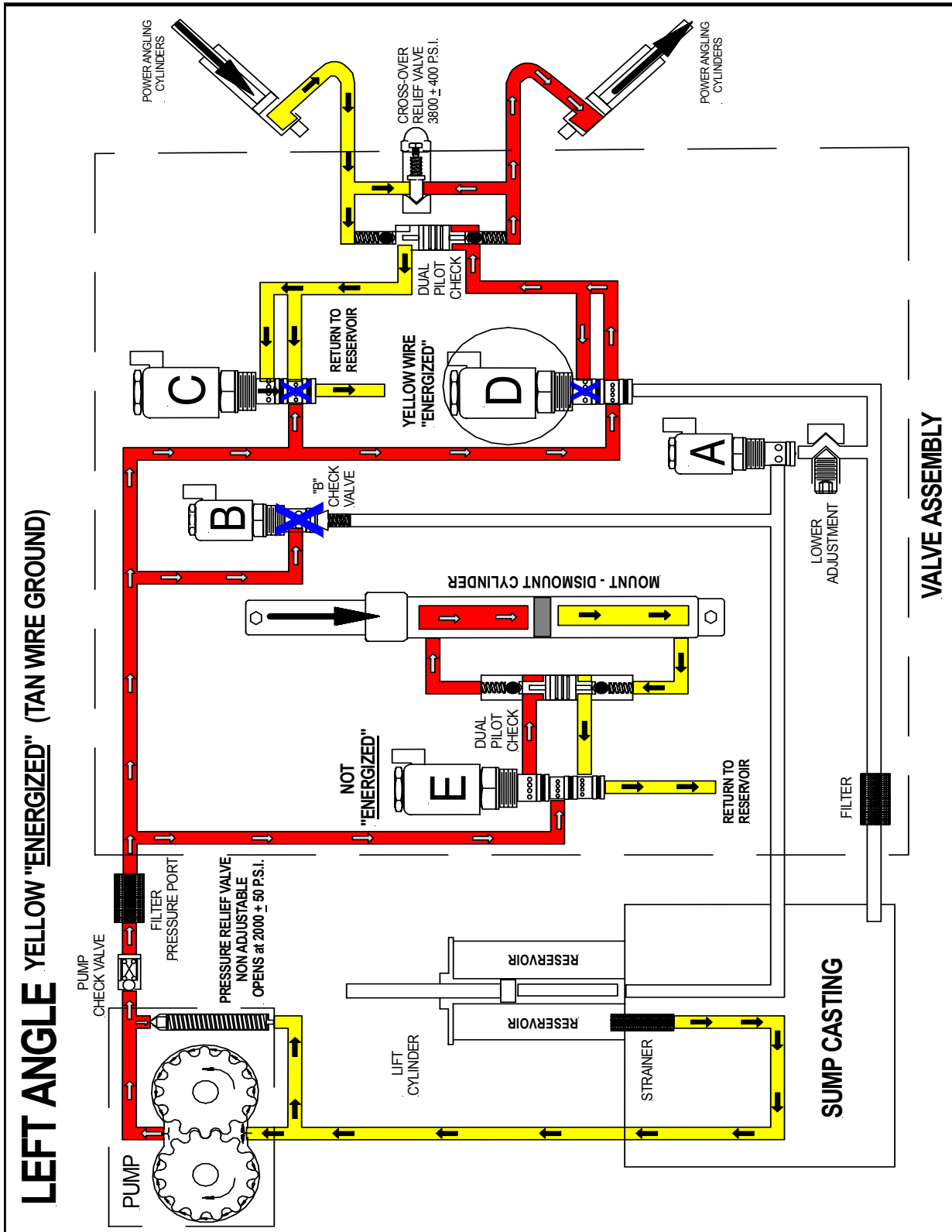

FIGURE 1-5

E-68 & E-88 Angle Right, Motor and "C" Solenoid

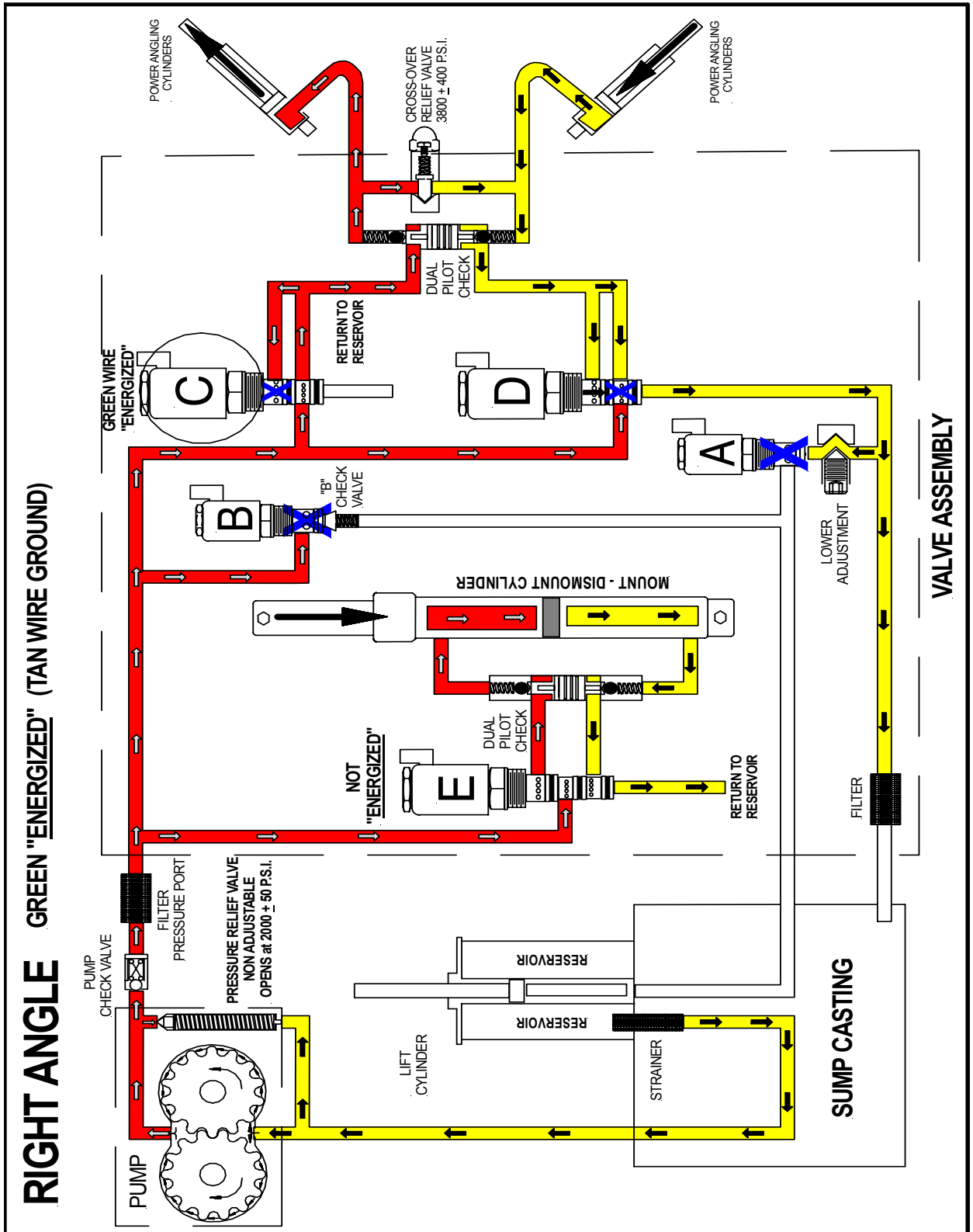

FIGURE 1-6

E-58H & E-78 Raise, Motor and "B" Solenoid

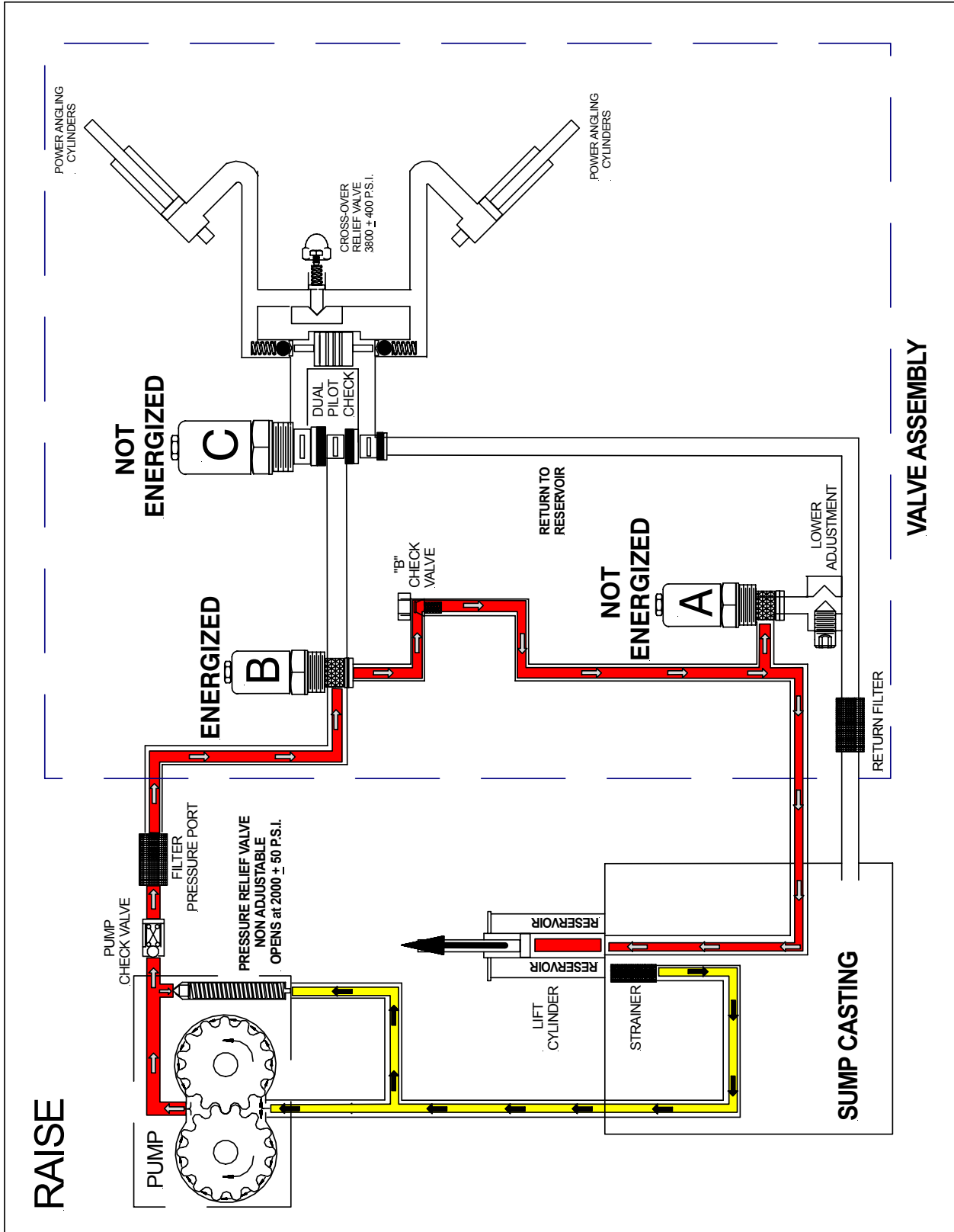

FIGURE 1-7

E-58H & E-78 Lower, "A" Solenoid

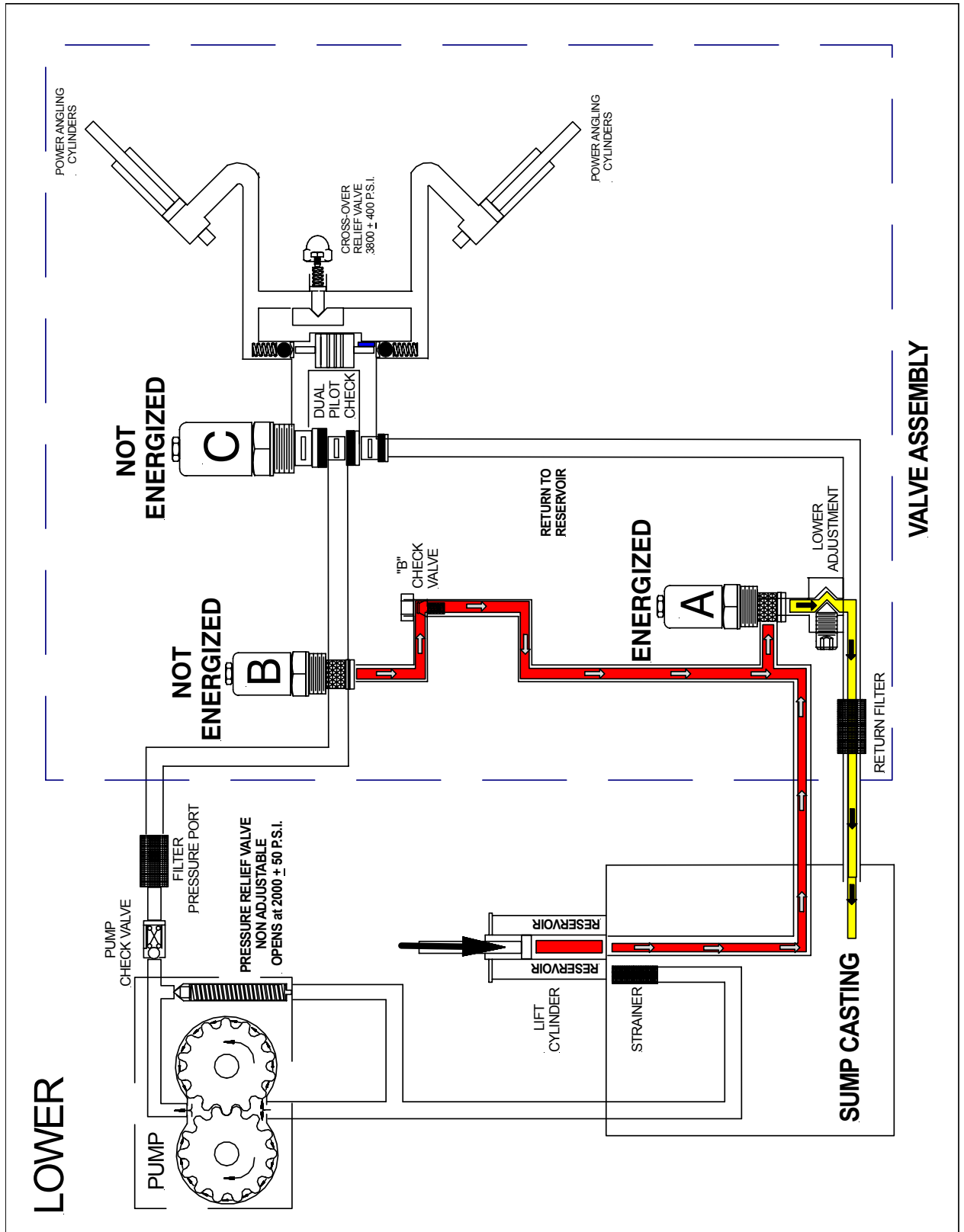

FIGURE 1-8

E-58H & E-78 Angle Left, Motor only

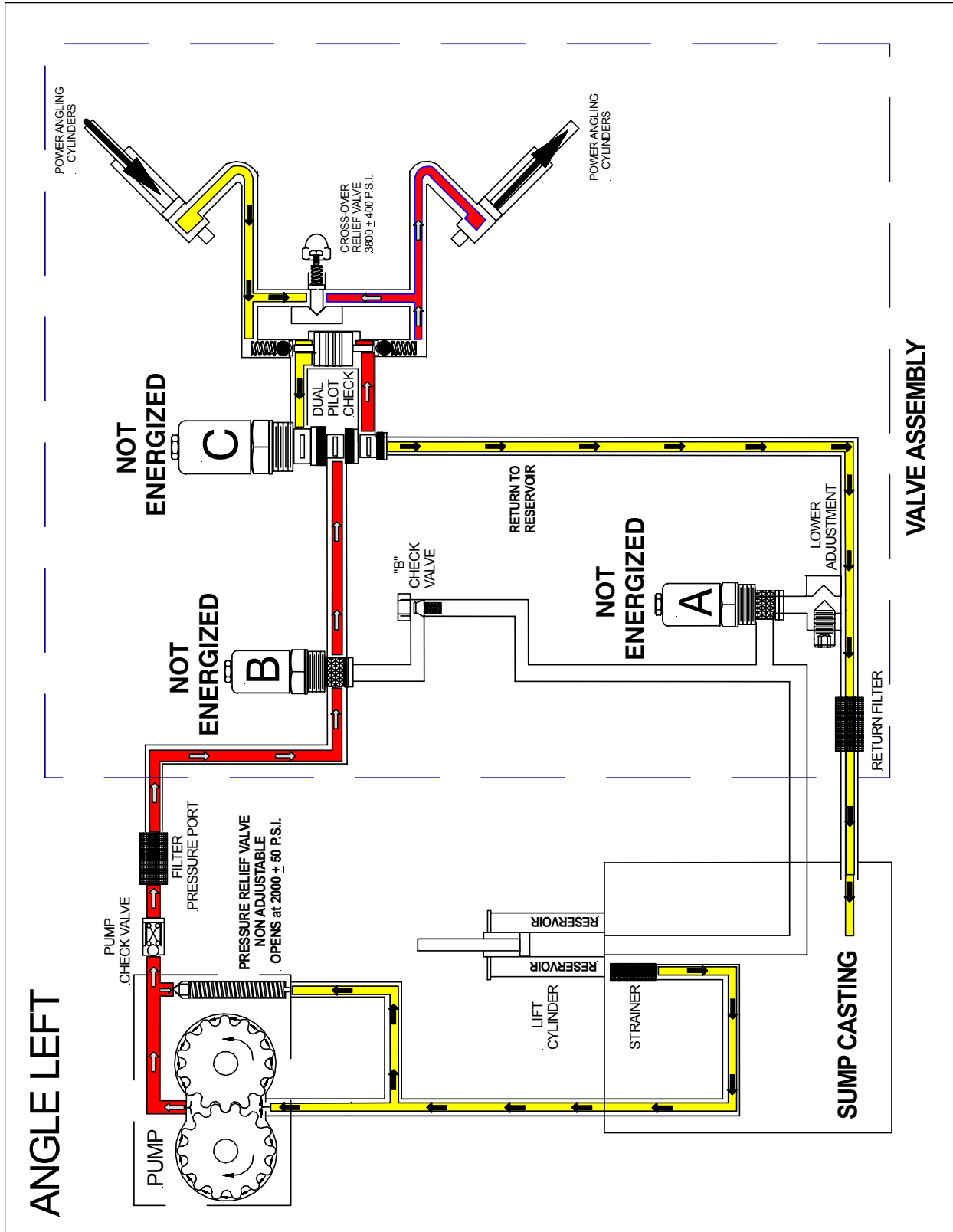

FIGURE 1-9

E-58H & E-78 Angle Right, Motor and "C" Solenoid

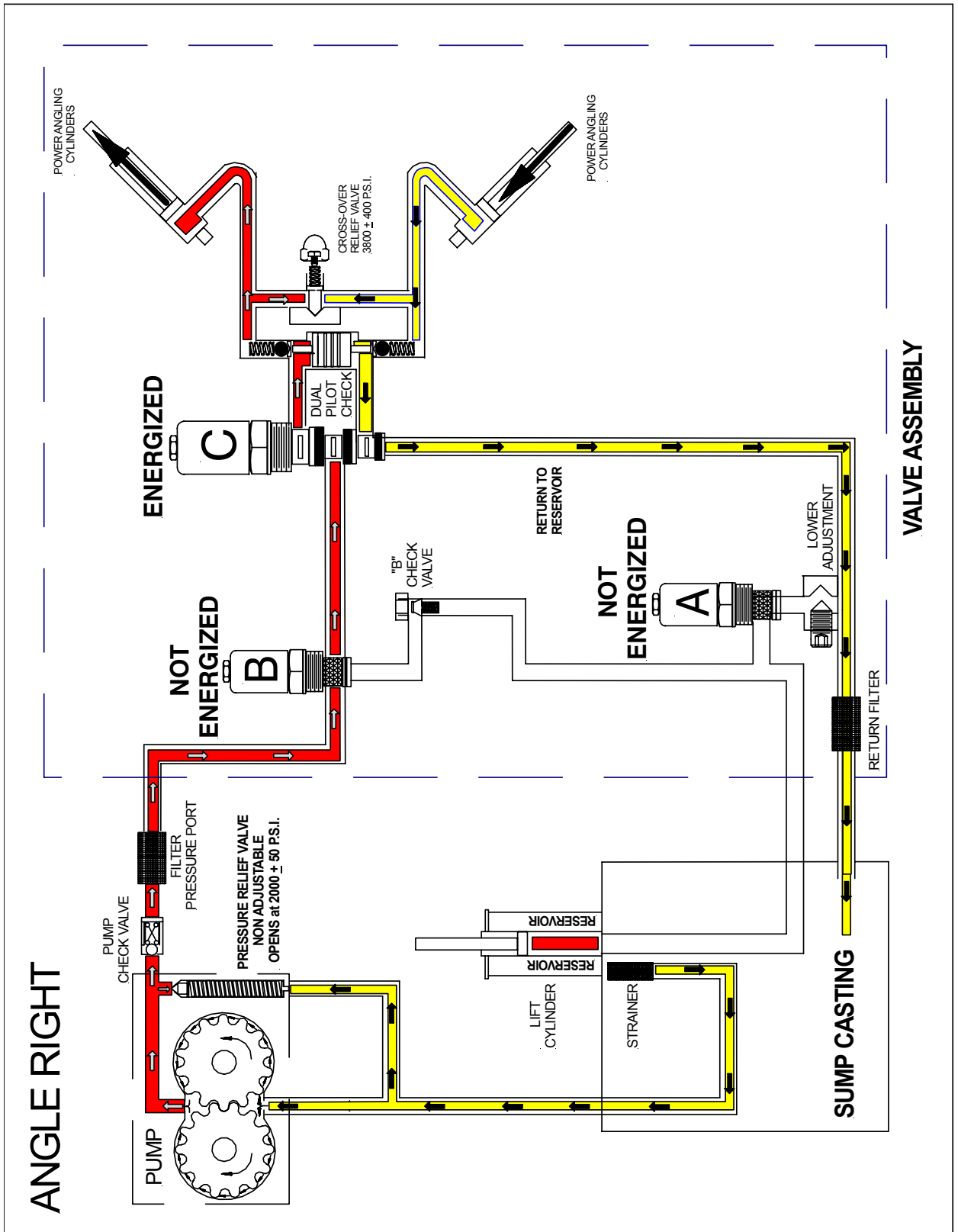

FIGURE 1-10

ELECTRO LIFT® UNIT COMPONENTS

E-58H, E-68, E-78 & E-88 UNIT COMPONENTS

MOTOR (4-1/2")

Iskra - Two terminal

The Iskra motor is a four pole, electromagnet motor which consists primarily of a 4-1/2" diameter solid steel frame, armature, brushes, field coils and pole pieces. This motor can be used on vehicles with either the common negative ground electrical system or the positive ground electrical system.

HYDRAULIC PUMP

The pump in a hydraulic system employs an external source of power to apply a force to a liquid. A pump develops no power of its own. It simply transfers power from an external source (the electric motor on the E-58H, E-68, E-78 & E-88 unit) to the liquid in the hydraulic system.

The basic operating principles of the hydraulic pump used in the E-58H, E-68, E-78 & E-88 units are quite simple. Figure 1-11 illustrates the basic components of a positive displacement gear type pump and their functions. The pumping action takes place within the pump chamber which is connected to the reservoir by the intake line. The pump chamber has an outlet line in which the liquid under motion and pressure leaves the pump to perform work.

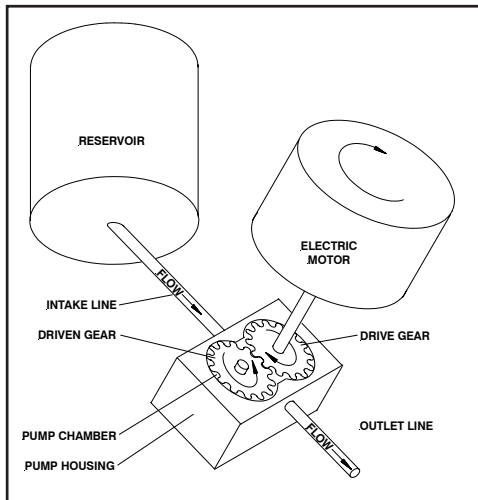

FIGURE 1-11

PRESSURE RELIEF VALVE

A basic pressure relief valve is shown in Figure 1-12. It consists of a poppet valve and a valve spring. Both are located in a passage which connects the inlet passage to the outlet passage. The poppet valve is normally held closed by the valve spring, sealing the connecting passage from the pressurized outlet passage. The poppet valve, being a piston, is exposed to the pressurized hydraulic fluid in the outlet passage. Whenever the hydraulic pressure against the poppet valve becomes greater than the pressure being exerted

on the poppet valve from the opposite direction by the valve spring, the poppet valve will open. This allows some of the pressurized hydraulic fluid to flow through the connecting passage to the non pressurized inlet passage. The effect is to lower the pressure in the outlet passage which will allow the valve spring to close the poppet valve again.

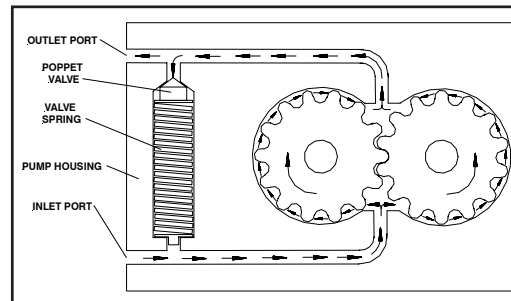

FIGURE 1-12

Under a condition, such as when a hydraulic cylinder is extended to the end of its stroke, eliminating additional space for the pressurized hydraulic oil to be pumped into, the alternate opening and closing of the poppet valve controls the pump's pressure output and provides an escape for the pressurized hydraulic fluid.

The pressure relief valve used in the E-58H, E-68, E-78 & E-88 pump, while more sophisticated than the one described, functions in the same manner. The pump pressure relief valve may be adjusted to the specified pressure of 2000 P.S.I. by adjusting the set screw after installing a suitable pressure gauge of 2500 P.S.I. in the circuit.

SOLENOID VALVES

Hydraulic valves are simple in concept and all have the same basic function: Control the direction of oil flow.

Each Solenoid Valve consists of two components: the Cartridge and the Coil.

Cartridge

The Cartridge consists of the hydraulic valve mechanism and an armature which enables the valve mechanism to be operated and controlled electrically. The Cartridge is designed to screw in and out of the E-58H, E-68, E-78 & E-88 units much like the typical "spark plug".

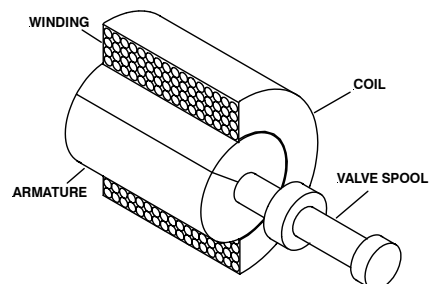

FIGURE 1-13

ELECTRO LIFT® UNIT COMPONENTS CONT.

Coil

The Coil is the electrical component which operates the Cartridge's valve mechanism by producing magnetism which pulls the Cartridge's armature toward it. Since the armature is connected to the valve mechanism's only moving part, it is pulled by the armature.

Figure 1-13 illustrates the typical Coil. Whenever electrical current flows to the Coil, it flows through the winding, which consists of numerous turns of copper wire. The flow of current through the winding produces a magnetic field which pulls the soft iron armature further into the Coil.

The armature pulls the valve spool or poppet valve into its alternate (energized) position. Not illustrated is an integral coil spring, which is compressed when the armature is pulled by the magnetism.

When the current flow ceases, the magnetic field disappears and the compressed coil spring pushes the armature back to its original (de-energized) position.

"A" Solenoid Valve E-58H, E-78 & E-88

The "A" Cartridge contains a poppet valve whose static or de-energized position is closed. Its energized position is open.

The "A" Solenoid Valve retains hydraulic fluid in the lift cylinder. It is energized (opened) to allow the hydraulic fluid to flow from the lift cylinder back to the reservoir, enabling the plow to lower by gravity.

The "A" Solenoid Valve is designed to remain energized (open) while the plow is lowered, plowing snow. This is the "float" feature which insures that the plow maintains contact with the ground contour.

"B" Solenoid Valve E-58H, E-78 & E-88

The "B" Cartridge contains a poppet valve whose static or de-energized position is closed. Its energized position is open.

The "B" Cartridge contains a spool valve whose (energized) position allows the pressurized hydraulic fluid to flow to the lift cylinder, raising the plow.

The "B" Cartridge de-energized position retains the hydraulic fluid in the lift cylinder, holding the plow up.

"C" Solenoid Valve E-88 only

The "C" Cartridge contains a spool valve when in the energized position, the pressurized hydraulic fluid is diverted to the left power angling cylinder, angling the plow to the right. Also, the hydraulic fluid being forced from the retracting right power angling cylinder flows through the "D" Cartridge when de-energized back to the reservoir.

"C" Solenoid Valve E-58H & E-78 only

The "C" Solenoid valve is used on the E-58H & E-78 hydraulic unit for power angling. The "C" Cartridge contains a spool valve whose static (de-energized) position allows the pressurized hydraulic fluid to flow to the right power angling cylinder which angles the plow to the left. At the same time, it allows the hydraulic fluid being forced from the retracting left power angling cylinder to flow through the "C" Cartridge back to the reservoir.

In the energized position, the pressurized hydraulic fluid is diverted to the left power angling cylinder, angling the plow to the right. Also, the hydraulic fluid being forced from the retracting right power angling cylinder flows through the "C" Cartridge back to the reservoir.

"D" Solenoid Valve E-88 only

The "D" Cartridge contains a spool valve when in the energized position, the pressurized hydraulic fluid is diverted to the left power angling cylinder, angling the plow to the right. Also, the hydraulic fluid being forced from the retracting right power angling cylinder flows through the "C" Cartridge when de-energized back to the reservoir.

"E" Solenoid Valve E-88 Only

The "E" Solenoid valve is used on the E-88 E-Z Mount Xpress for mounting and dismounting of the plow from the vehicle. The "E" Cartridge contains a spool valve whose static (de-energized) position allows the pressurized hydraulic fluid to flow to the live end of the mount cylinder which mounts the plow to the vehicle. At the same time, it allows the hydraulic fluid being forced from the dead end of the double acting mount/dismount cylinder to flow through the "E" Cartridge back to the reservoir.

In the energized position, the pressurized hydraulic fluid is diverted to the to the dead end of the mount cylinder which dismounts the plow from the vehicle. At the same time, it allows the hydraulic fluid being forced from the live end of the double acting mount/dismount cylinder to flow through the "E" Cartridge back to the reservoir.

ELECTRO LIFT® UNIT COMPONENTS CONT.

CHECK VALVES

Check valves are very simple devices that have two basic functions: They prevent fluid from passing through them in one direction, but they allow fluid to pass through them in the opposite direction.

In the E-58H, E-68, E-78 & E-88 a pump check valve is used to prevent hydraulic fluid from leaking back through the pump to the reservoir.

The E-58H, E-68, E-78 & E-88 unit uses one check valve located between the "B" Solenoid Valve and the lift cylinder. It prevents the hydraulic fluid in the lift cylinder from leaking back through the "B" Solenoid Valve which could cause the plow to drift down.

DOUBLE ACTING PILOT CHECK VALVE

The pilot check valve is more sophisticated in that it incorporates a piston in addition to the ball, seat and spring. It is located between the "C" and "D" Solenoid Valves on the E-68 & E-88 and next to the "C" valve on the E-58H & E-78. It has two functions: The first is to prevent the hydraulic fluid in either power angling cylinder from leaking back to the reservoir. The second is to allow the hydraulic fluid from the retracting power angling cylinder during the angling cycle to return to the reservoir. This is accomplished by the pressurized hydraulic fluid moving the piston which forces the check ball off its seat. The E-68 & E-88 also uses an additional pilot check valve located next to the "E" valve. This allows the "E" valve to control the mount/dismount function.

CROSSOVER RELIEF VALVE

When plowing snow, a snow plow can be exposed to damaging forces caused by impact with hidden obstructions, ends of curbs, etc. With power angling, these damaging forces can damage not only the snow plow but also the vehicle. The crossover relief valve has the function of protecting the snow plow system against these damaging forces under normal snow plowing conditions. The crossover relief valve, cannot protect the system from damaging forces that are too great due to abusive snow plowing conditions.

Basically, the crossover relief valve functions exactly like the previously described pump relief valve. It's designed to open at a specific pressure. In this instance, the pressure is not produced by the pump but rather by the damaging force. As an example, assume that the right corner of the plow runs into the end of a curb. The impact will attempt to collapse the right power angling cylinder. As a result, very high hydraulic pressure is produced within the cylinder. When the produced pressure is high enough, it opens the crossover relief valve,

allowing the highly pressurized hydraulic fluid to flow directly to the left power angling cylinder.

When the crossover relief valve functions in this manner, the excessive pressure is released, the excessive energy produced by the impact is absorbed, and the result is only a change in angled position of the plow.

The crossover relief valve is factory set to the specified pressure of 3800 P.S.I. \pm 400 this setting

SOLENOID SWITCH

The E-58H, E-68, E-78 & E-88 motor requires more current or amperage to operate than the vehicle wiring, vehicle ignition switch or toggle switches have the capacity to handle. The solenoid switch is essentially a heavy duty switch with the capacity to handle the heavy current required by the motor. It is closed electrically by the solenoid to convey the heavy current directly from the vehicle battery via heavy gauge electrical cable. The solenoid, which functions essentially the same as the previously described solenoid valves, receives its low amperage current at the proper times via the wiring harness. This solenoid must be grounded to operate properly.

FILTERS

Cleanliness is perhaps the single most important ingredient in assuring a hydraulic system's reliability. Should the hydraulic fluid become contaminated, malfunction and permanent damage to the hydraulic system may occur. For this reason, all the E-58H, E-68, E-78 & E-88 units are equipped with a filter system consisting of:

- A fine screen strainer on the reservoir pump inlet.
- A high pressure filter on the pressure side of the pump.
- A return filter on the power angling block leading back to the reservoir.

With this system, the hydraulic fluid is filtered as it leaves the reservoir on its way to the pump and on the Power Angling units filtered again as it leaves the pump. Because clean hydraulic fluid is most important to insure Solenoid Valve reliability, the hydraulic fluid leaving all cylinders is filtered before passing returning to the reservoir. The filter screen, high pressure and return filter are easily removed for periodic cleaning or replacement.

IMPORTANT:

Should the hydraulic fluid become contaminated, it will be necessary to replace all the hydraulic oil in the system. The complete system (hydraulic unit, power angling cylinders, mount cylinder and hoses) should be flushed. Flush the system with Meyer Hydra-Flush™ Fluid M-2.

SECTION 2 - DIAGNOSIS

CONTENTS

	E-68 & E-88	E-58H	E-78
GENERAL INFORMATION	20	26	26
TESTING TIPS	20	26	26
“RAISE” Troubleshooting	21	31	27
“LEAK DOWN” Troubleshooting	22	32	28
“LOWER” Troubleshooting	22	32	28
“ANGLE LEFT” Troubleshooting	23	33	29
“ANGLE RIGHT” Troubleshooting	24	34	30
“WILL NOT HOLD ANGLE” Troubleshooting	25	34	29
“MOUNTING” Troubleshooting	25	N/A	N/A
“DIS-MOUNTING” Troubleshooting	25	N/A	N/A

DIAGNOSTIC FLOW CHART FOR E-68 & E-88 Unit

These charts are intended to be used as an aid in diagnosing problems on the E-88 unit. They are not a substitute for factory training and experience. Be certain to read the General Information and Testing Tips sections before attempting any troubleshooting.

IMPORTANT: Maintenance and repairs must be performed with the moldboard on the ground.

General Information

Before any troubleshooting is started, make certain the following conditions are met.

1. The moldboard is pointing straight ahead. This can often be done by coupling the left cylinder into the right cylinder and pushing the moldboard by hand.
2. The power angling cylinders must be installed correctly on to the plow assembly. The left cylinder (Driver's side) has a hose attached with a female half of a coupler at the end; the right cylinder (Passenger side) has a hose attached with a male half of a coupler at the end.
3. The solenoid wires must be on their proper coil. The "A" coil (black and tan wires) on power angling block labeled "BLK". The "B" coil (red and tan wires) on power angling block labeled "RED". The "C" coil (green and tan wires) on power angling block labeled "GRN". The "D" coil (yellow and tan wires) on power angling block labeled "YEL". The "E" coil (purple and tan wires) on power angling block labeled "PUR".

TESTING TIPS

Many tests do not require removing the Electro Lift® unit from the vehicle. However, more thorough testing can be performed using the Meyer Test Stand which allows direct pressure and amperage readings.

1. Using a screwdriver or other small tool to check for magnetism of the solenoid coils "A", "B", "C", "D" and "E". Place the tool on the nut securing the coil and have an assistant operate the switch. You should feel strong magnetic attraction.
2. Use a test light or volt meter to determine whether there is power at the harness.
3. When determining AMP draw of the motor, always obtain the highest value possible, i.e, at maximum raise or maximum angle with motor running.
4. Proper rotation for the motor is indicated by an arrow located on top side of the (Part # 15889) pump.
5. The pump shaft of a good pump can be turned smoothly using two fingers. If it can't be turn easily, the pump is too tight and must be replaced.
6. Pump pressure can be measured at an angle hose (note pressure at full angle) or in the pressure filter port (an adaptor is necessary for the filter port). Note: The E-68 & E-88 Unit has a non adjustable pressure relief valve.
7. Flush the complete system including unit, hoses and power angling rams with Meyer Hydra-Flush™ Fluid M-2.

E-68 CONTROLLER OPERATION

- The snow plow should only be in operation when the vehicle ignition switch and the control switch are in the "ON" position. Care should be taken to insure that the control switch is kept dry and free from moisture during normal operation.
- When the control switch is turned "On," the on/off button will illuminate. Individual touch pads operate the functions of the snow plow: (Up), (Angle Left), (Angle Right), and (Down).
- Lowering of the snow plow an inch at a time is possible by tapping the down arrow in short intervals. Holding down the down arrow will activate a float light located in the upper right corner of the control switch. This light indicates the snow plow is now in the Lower/Float position. In this position the snow plow will be able to follow the contour of the road and the snow plow can also be angled to the left or right. Touching the up arrow automatically cancels the Lower/Float position.
- While angling left or right or raising the snow plow if the button is pressed for more than four seconds the operation will be cancelled. This feature eliminates unnecessary amp draw from the vehicle charging system.
- The auto lower button when pressed will illuminate the light above it and allows the plow to lower automatically when the vehicle is shifted into reverse and raise automatically when shifted out of reverse. To turn off the auto lower mode simply press the auto lower button again.
- The Shake button when pressed will shake the plow left and right for three seconds. This function is used to shake off any snow which may be stuck to the plow. This function is only available within the last ten seconds of an angle, raise or lower operation. If you want to cancel shake once it is presses simply press the shake button again.
- The mount button when pressed will allow the mount/dismount switch on the hydraulic unit to mount or dismount the plow at the same time none of the other function will operate. (angle left, angle right, raise or lower will not work). When the mount button is pressed again the mount/dismount switch will not work. All plow functions (left, right, raise and lower) will now be available. Once the mount button is pressed it will only allow the plow to be removed or attached to the vehicle within ten minutes. When the ten minutes expires the mount/dismount switch will not work. If the mount/dismount switch is pressed for more than ten seconds the operation will be cancelled. This feature eliminates unnecessary amp draw from the vehicle charging system.
- This switch is self diagnosing. The monitor light is located in the upper left corner next to the float light of the control switch. When the monitor light turns on and begins to flash the control switch is sensing a problem with a specific coil/connection on the hydraulic unit. The diagnostic key is on the back side of your control switch.

E-68 & E-88 ONLY

SNOW PLOW WILL NOT RAISE

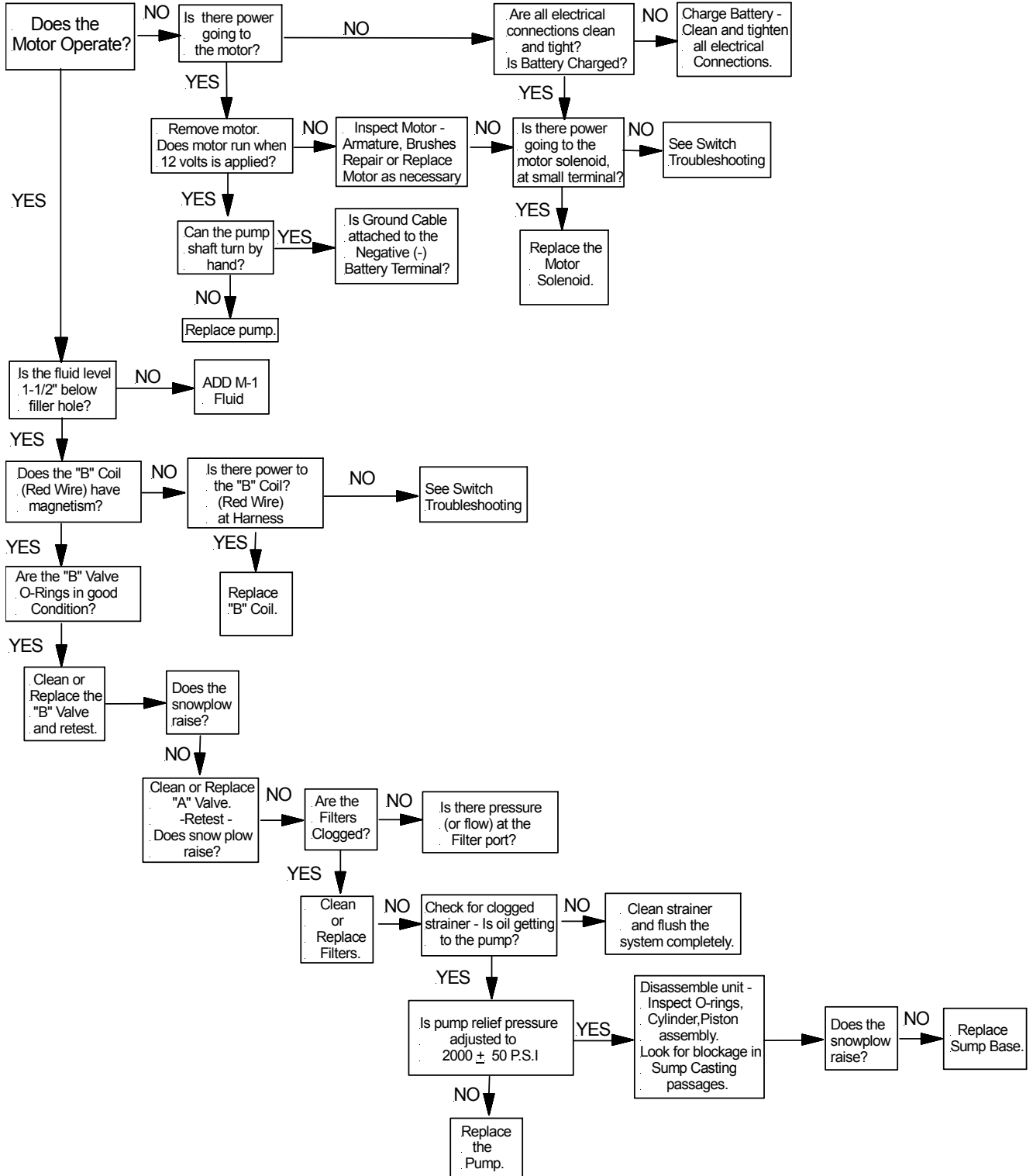

E-68 & E-88 ONLY

SNOW PLOW LEAKS DOWN

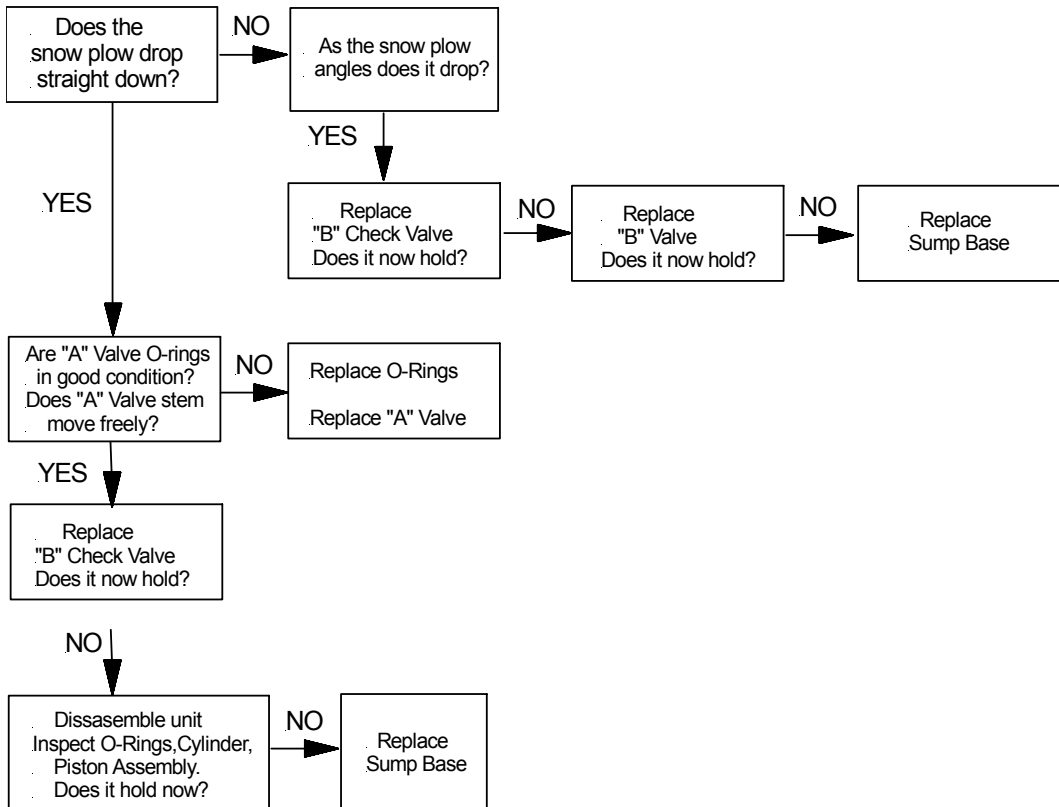

SNOW PLOW WILL NOT LOWER

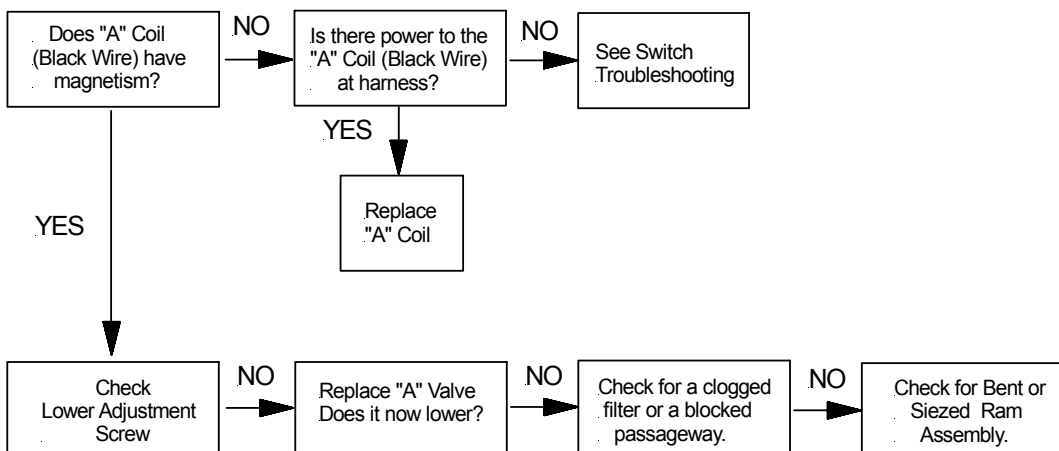

E-68 & E-88 ONLY

SNOW PLOW WILL NOT ANGLE LEFT

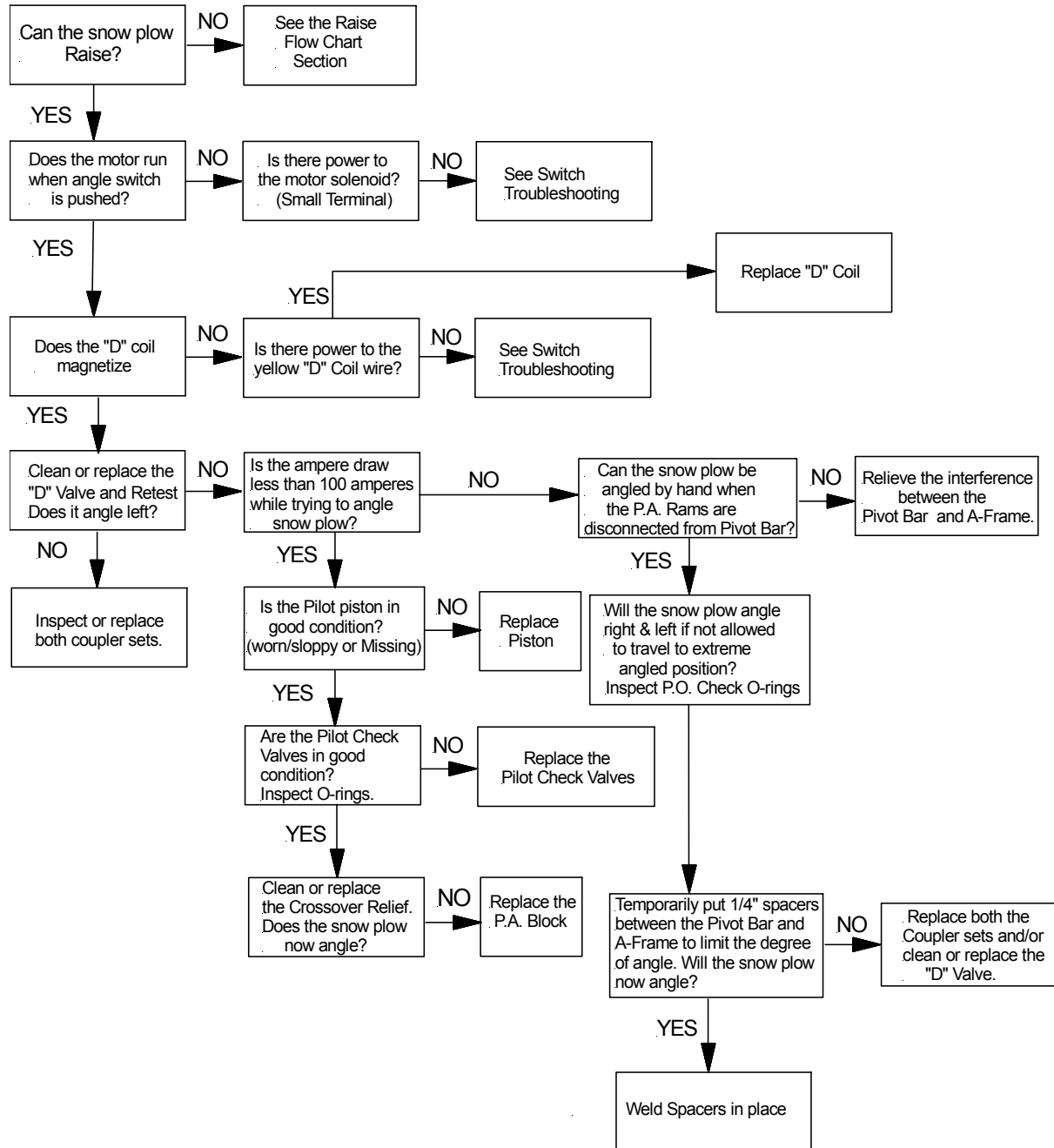

E-68 & E-88 ONLY

SNOW PLOW WILL NOT ANGLE RIGHT

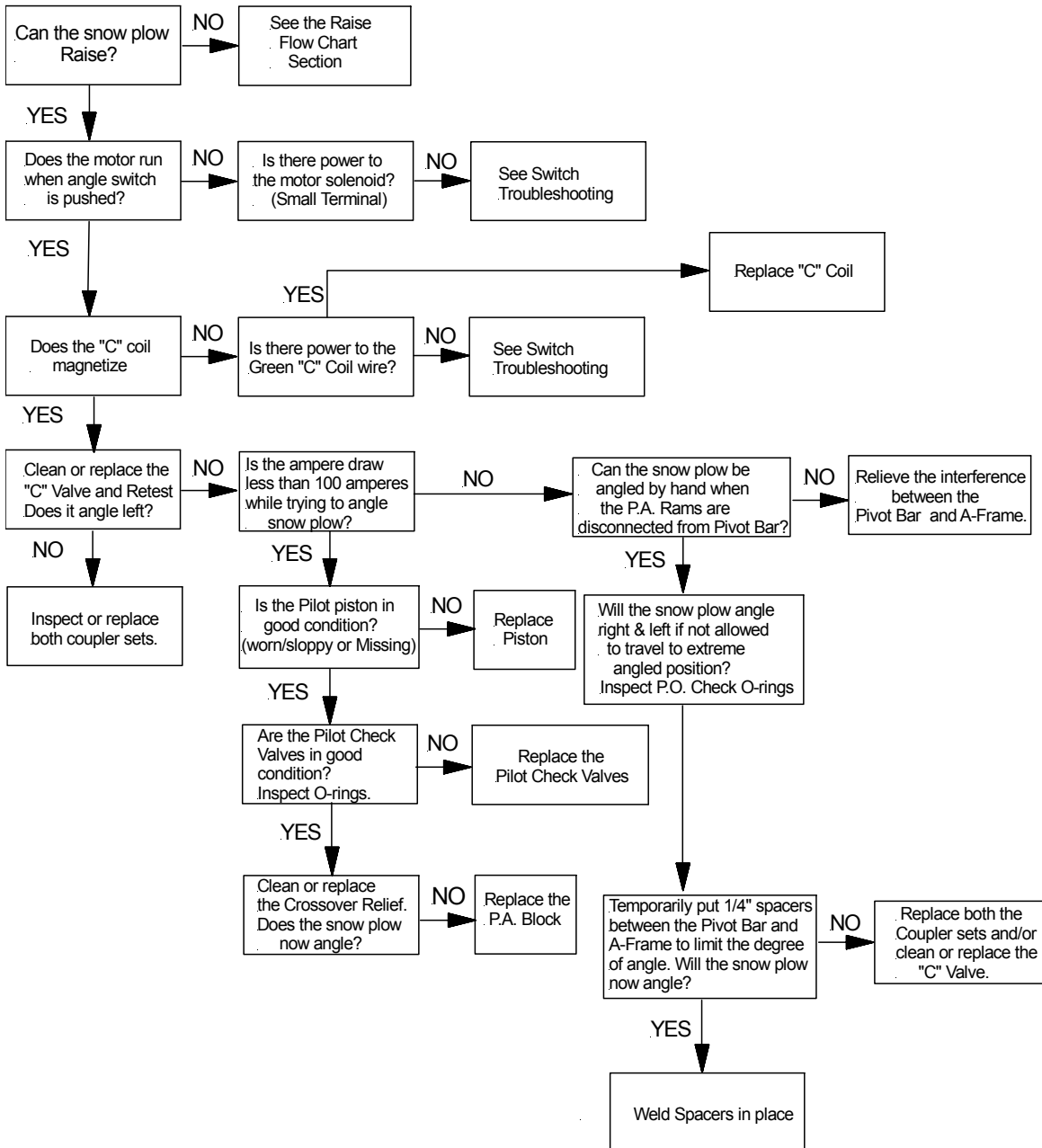

E-68 & E-88 ONLY

SNOW PLOW WILL NOT HOLD ANGLE

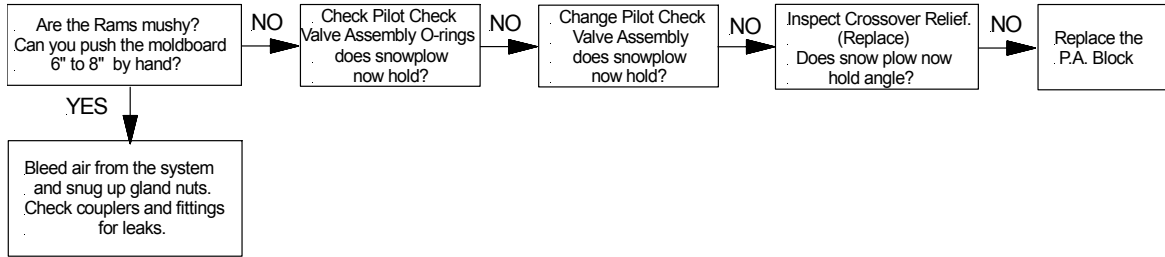

SNOW PLOW WILL NOT MOUNT

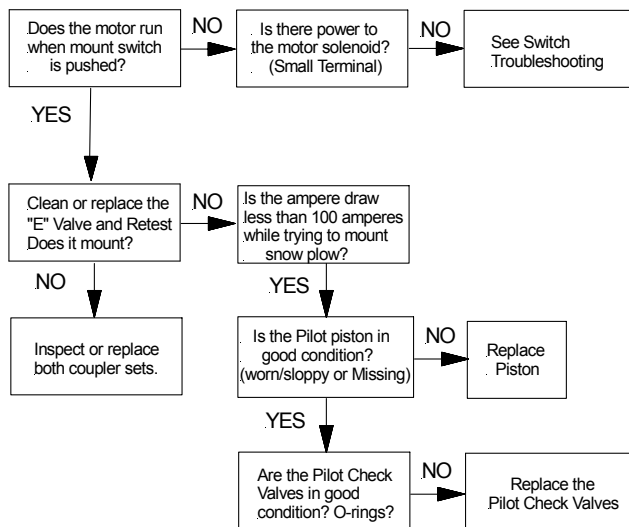

SNOW PLOW WILL NOT DIS-MOUNT

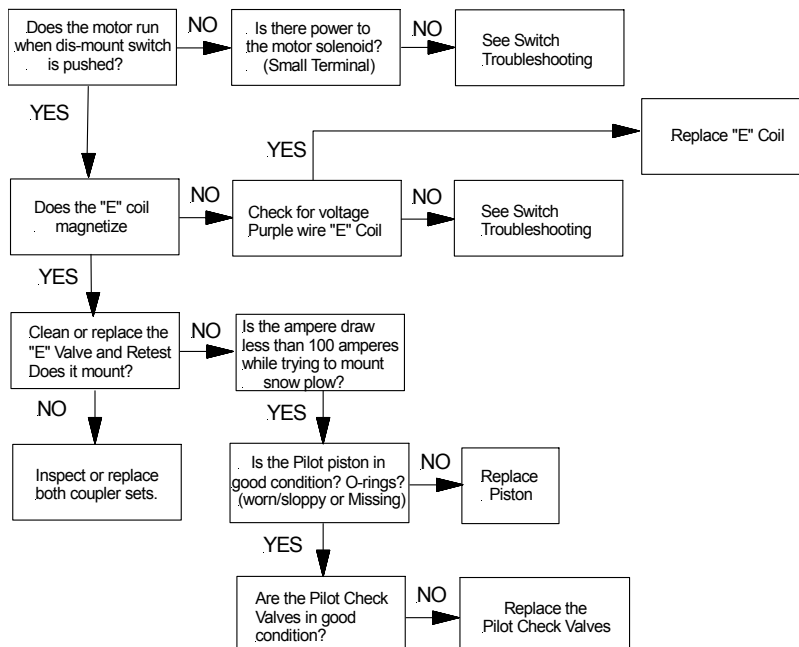

DIAGNOSTIC FLOW CHART FOR E-58H & E-78 Unit

These charts are intended to be used as an aid in diagnosing problems on the E-58H & E-78 unit. They are not a substitute for factory training and experience. Be certain to read the General Information and Testing Tips sections before attempting any troubleshooting.

IMPORTANT: Maintenance and repairs must be performed with the moldboard on the ground.

General Information

Before any troubleshooting is started, make certain the following conditions are met.

1. The moldboard is pointing straight ahead. This can often be done by coupling the left cylinder into the right cylinder and pushing the moldboard by hand.
2. The power angling cylinders must be installed correctly on to the plow assembly. The left cylinder (Driver's side) has a hose attached with a female half of a coupler at the end; the right cylinder (Passenger side) has a hose attached with a male half of a coupler at the end.
3. The solenoid wires must be on their proper coil. The "A" coil (black and tan wires) on power angling block labeled "BLK". The "B" coil (red and tan wires) on power angling block labeled "RED". The "C" coil (green and tan wires) on power angling block labeled "GRN".

TESTING TIPS

Many tests do not require removing the Electro Lift® unit from the vehicle. However, more thorough testing can be performed using the Meyer Test Stand which allows direct pressure and amperage readings.

1. Using a screwdriver or other small tool to check for magnetism of the solenoid coils "A", "B" and "C". Place the tool on the nut securing the coil and have an assistant operate the switch. You should feel strong magnetic attraction.
2. Use a test light or volt meter to determine whether there is power at the harness.
3. When determining AMP draw of the motor, always obtain the highest value possible, i.e, at maximum raise or maximum angle with motor running.
4. Proper rotation for the motor is indicated by an arrow located on top side of the (Part # 15889) pump.
5. The pump shaft of a good pump can be turned smoothly using two fingers. If it can't be turn easily, the pump is too tight and must be replaced.
6. Pump pressure can be measured at an angle hose (note pressure at full angle) or in the pressure filter port (an adaptor is necessary for the filter port). Note: The E-58H & E-78 Unit has a non adjustable pressure relief valve.
7. Flush the complete system including unit, hoses and power angling rams with Meyer Hydra-Flush™ Fluid M-2.

E-58H Only

The **current 22154 Electro-Touch Control** has been redesigned. The Touch Pad now has raised buttons and its circuitry has been changed from analog to digital, functions have not changed. For troubleshooting for power at the solenoids do not disconnect wires. To check for power, prick the wire through the insulation for testing. The **Electro-Touch Control** knows when a short or an open connection occurs and will go into overload mode for the function being activated. To reset the Touch Pad turn the switch on and off.

E-78 ONLY

SNOW PLOW WILL NOT RAISE

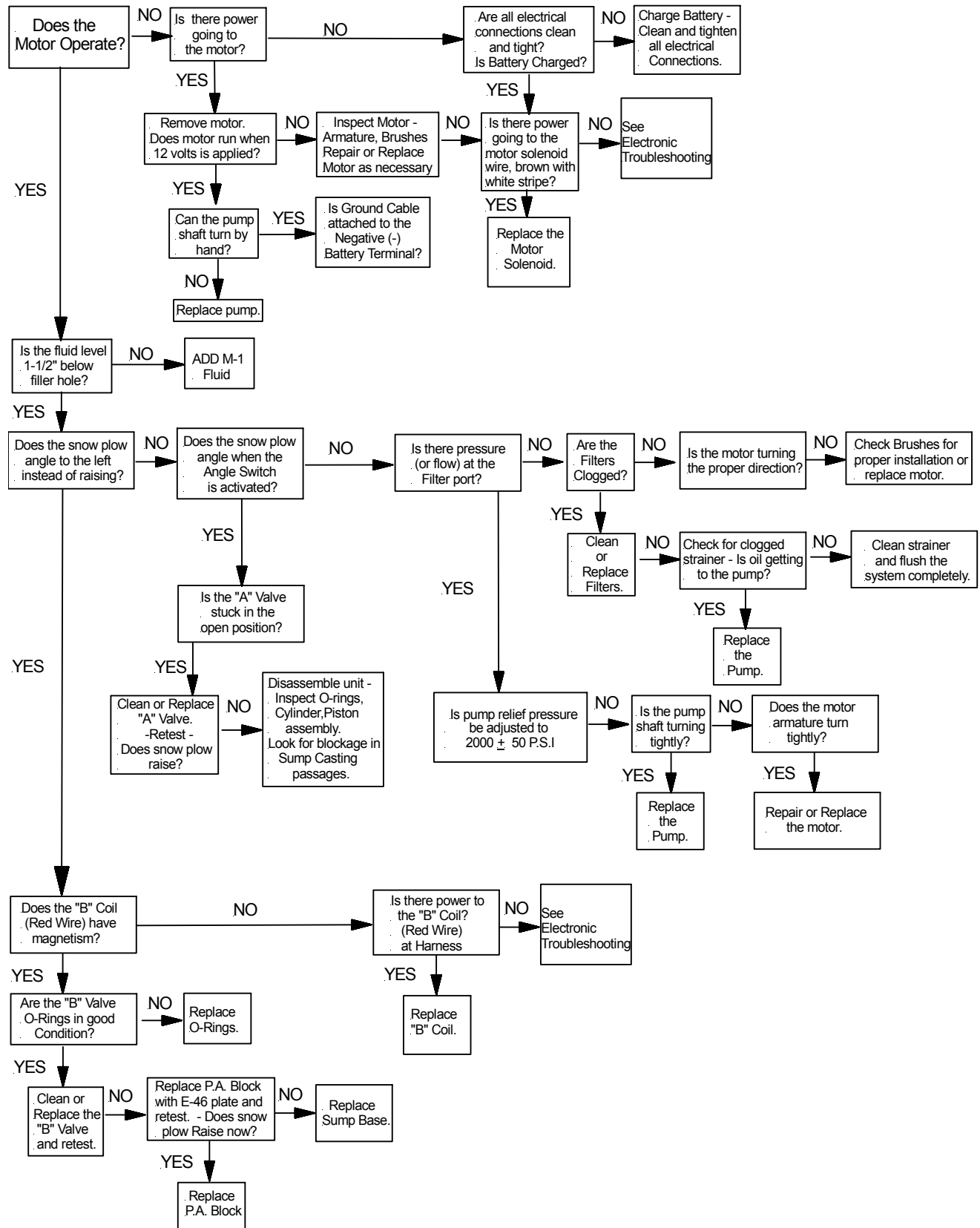

E-78 ONLY

SNOW PLOW LEAKS DOWN

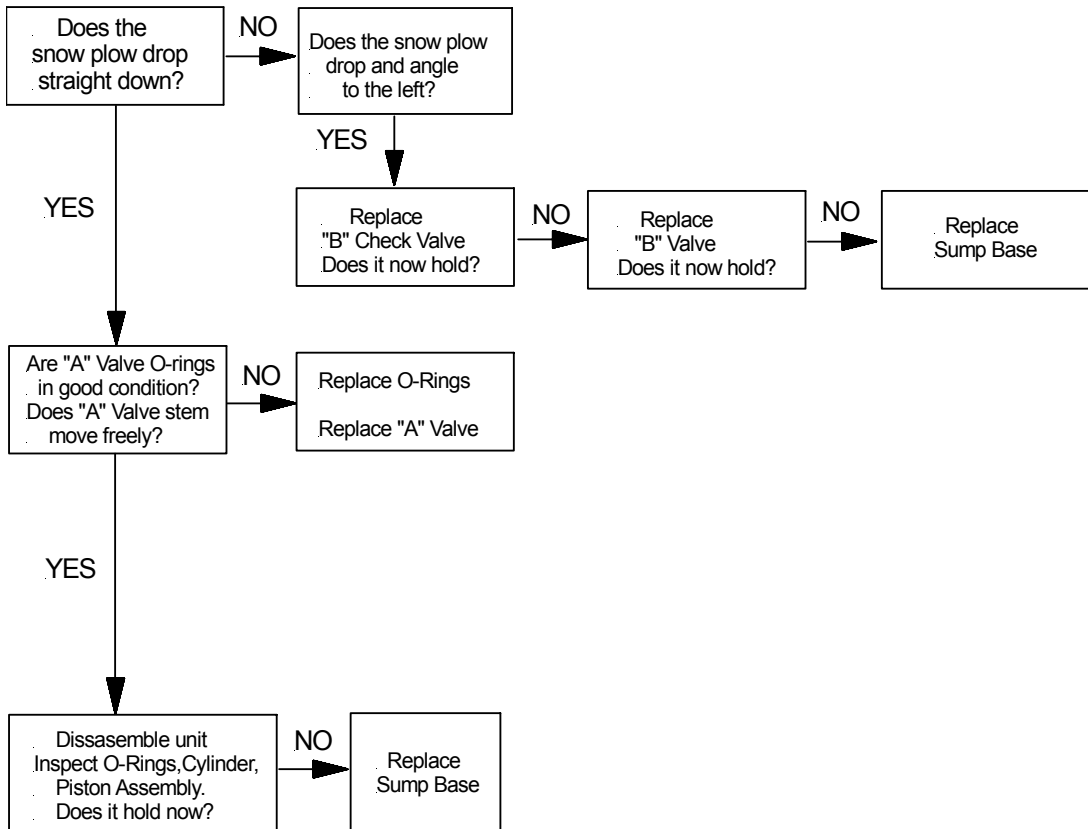

SNOW PLOW WILL NOT LOWER

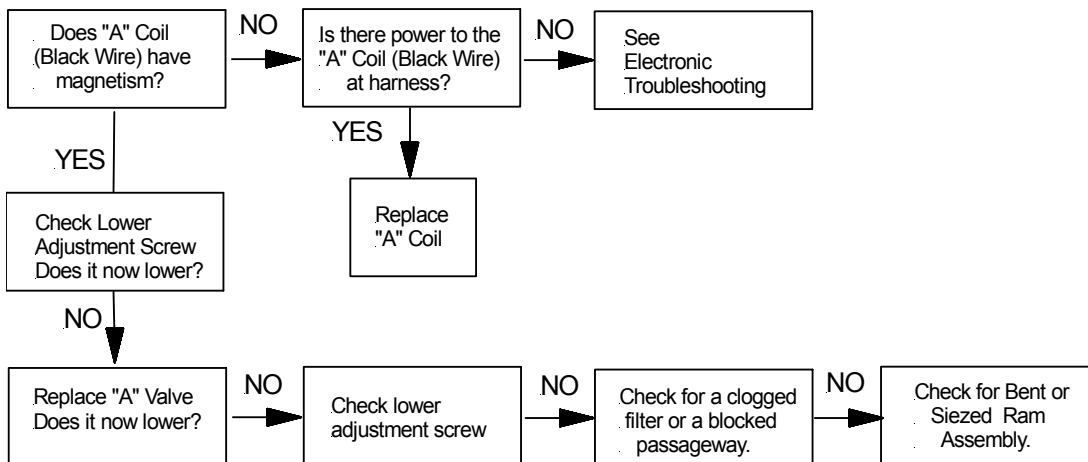

E-78 ONLY

SNOW PLOW WILL NOT ANGLE LEFT

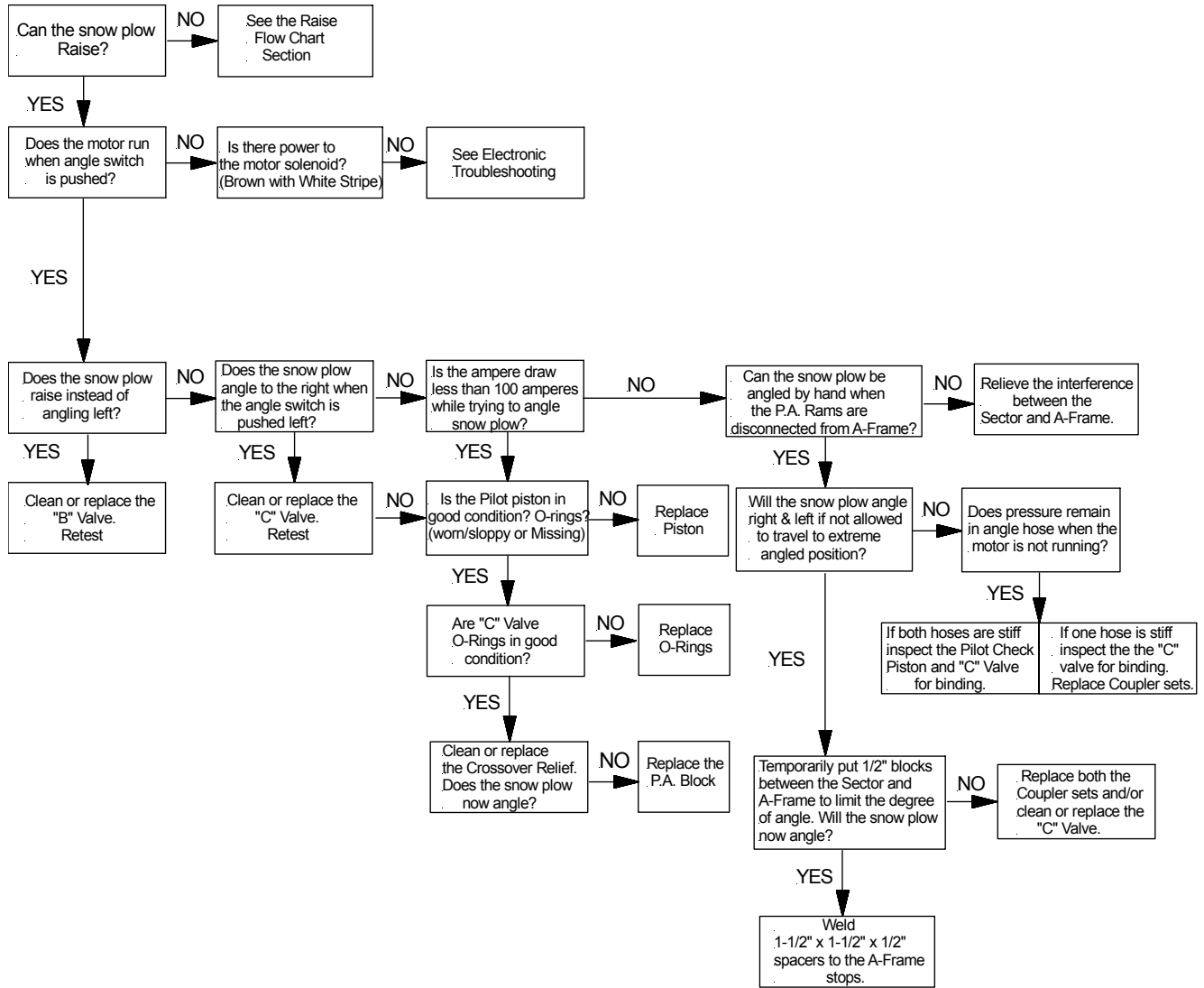

SNOW PLOW WILL NOT HOLD ANGLE

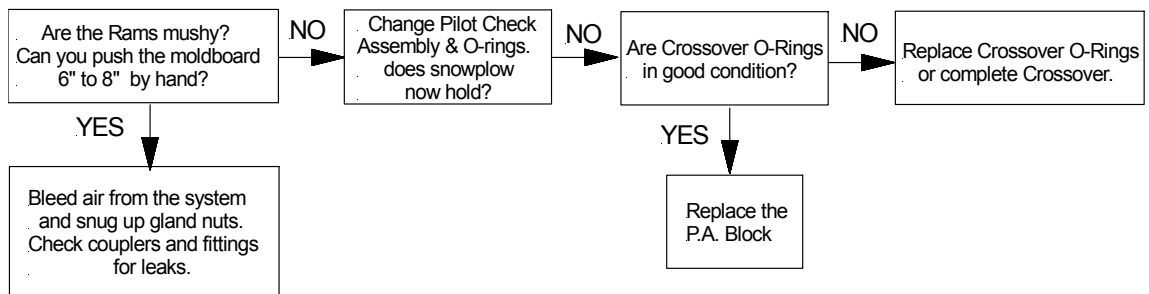

E-78 ONLY

SNOW PLOW WILL NOT ANGLE RIGHT

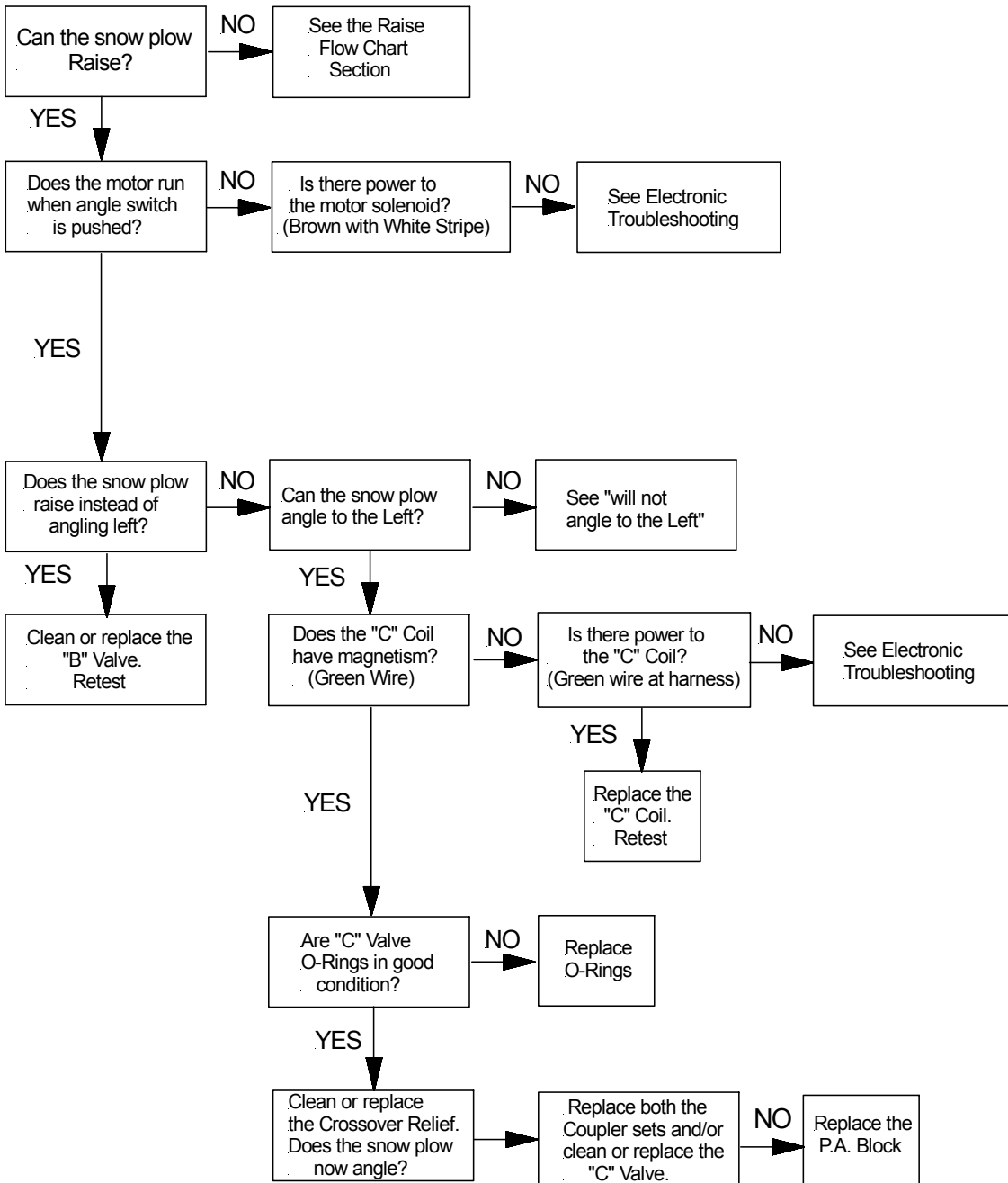

E-58H ONLY

SNOW PLOW WILL NOT RAISE

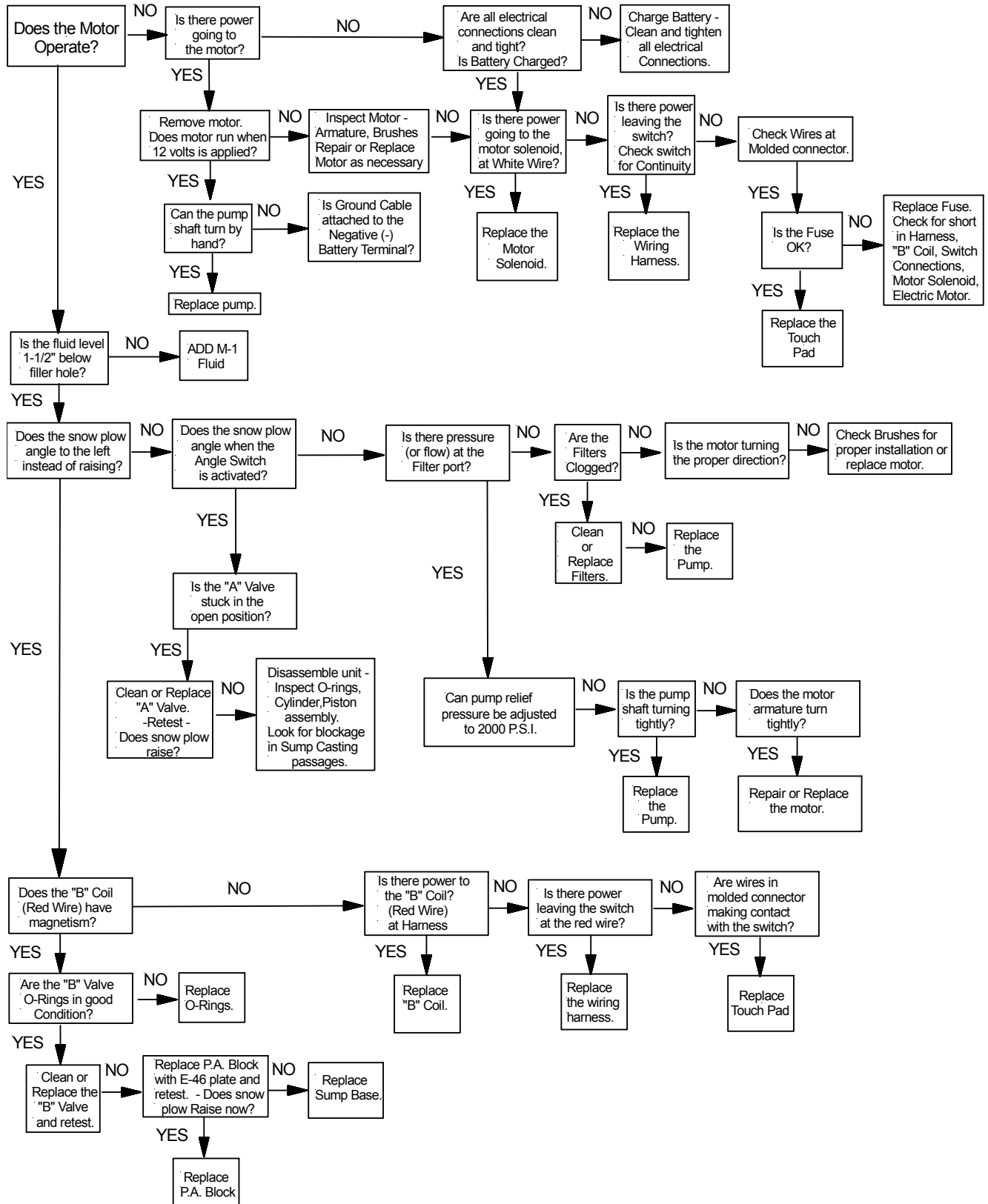

E-58H ONLY

SNOW PLOW LEAKS DOWN

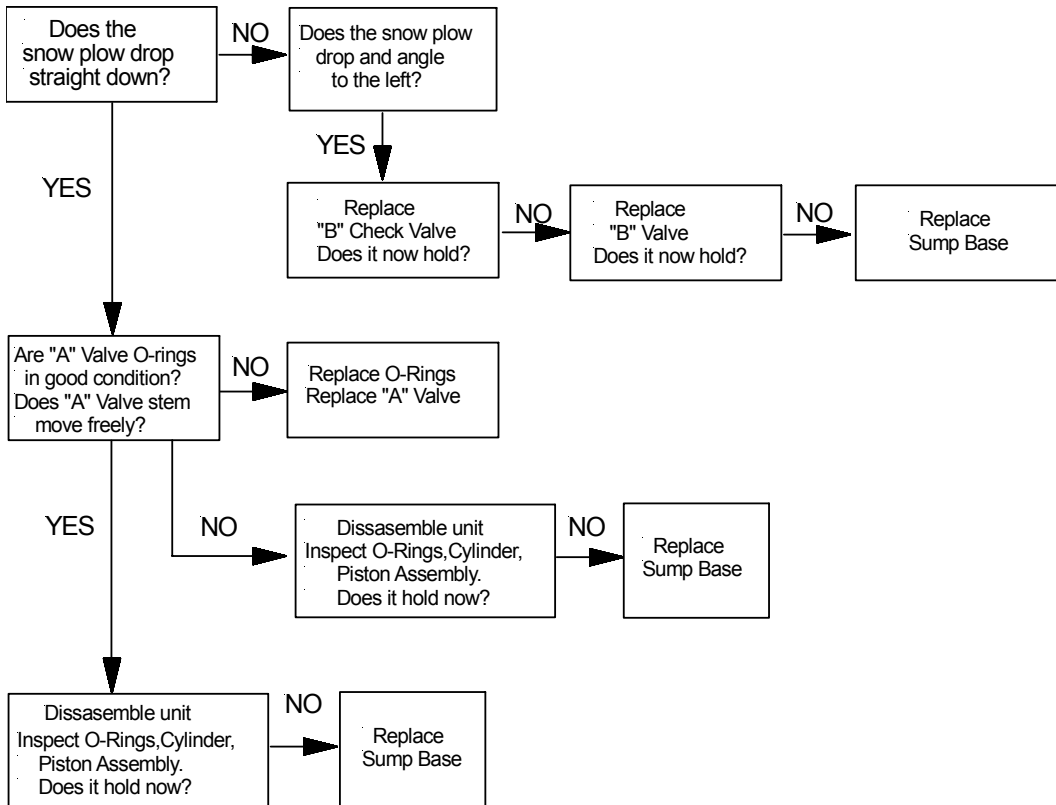

SNOW PLOW WILL NOT LOWER

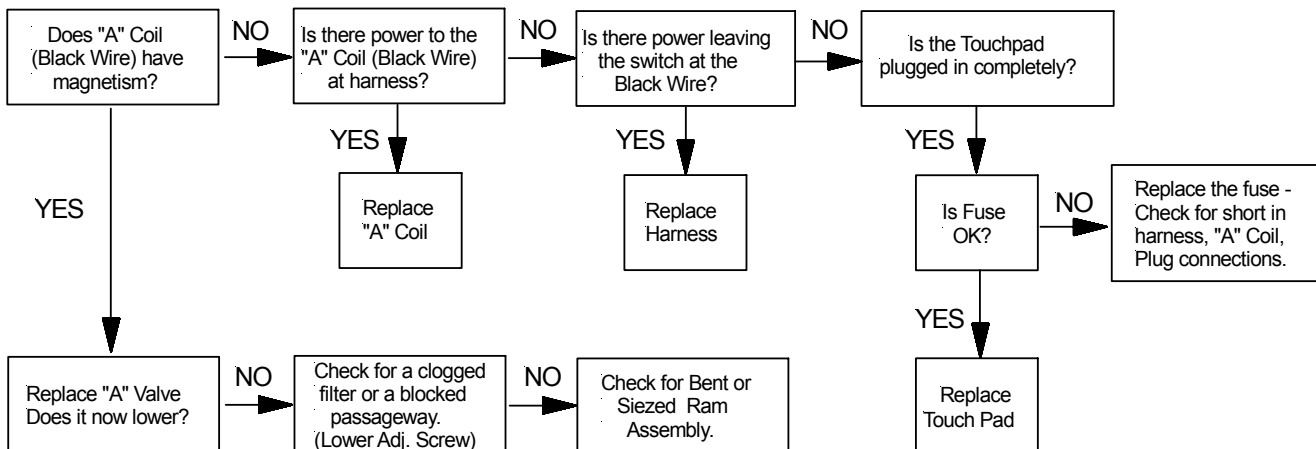

E-58H ONLY

SNOW PLOW WILL NOT ANGLE LEFT

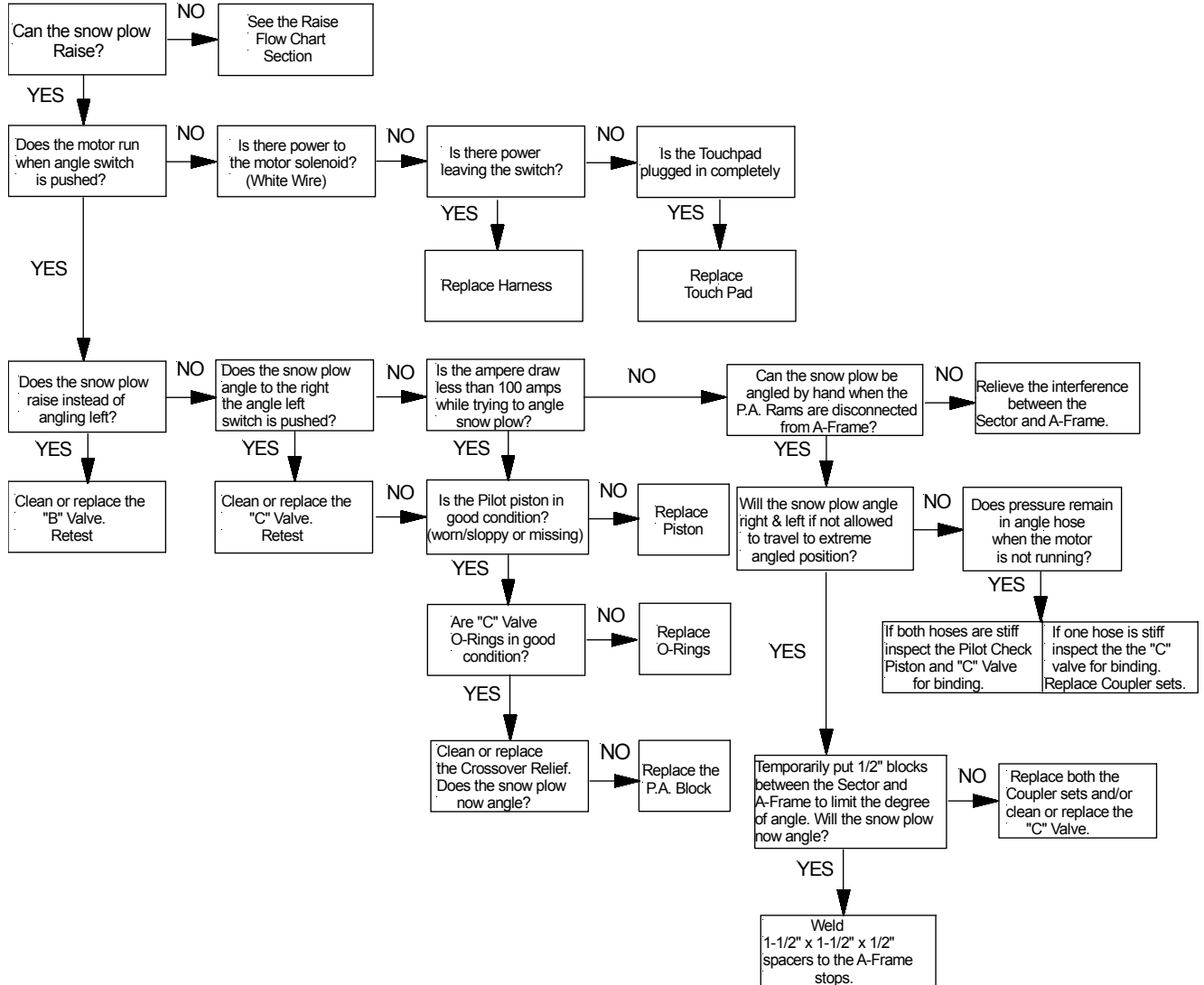

E-58H ONLY

SNOW PLOW WILL NOT ANGLE RIGHT

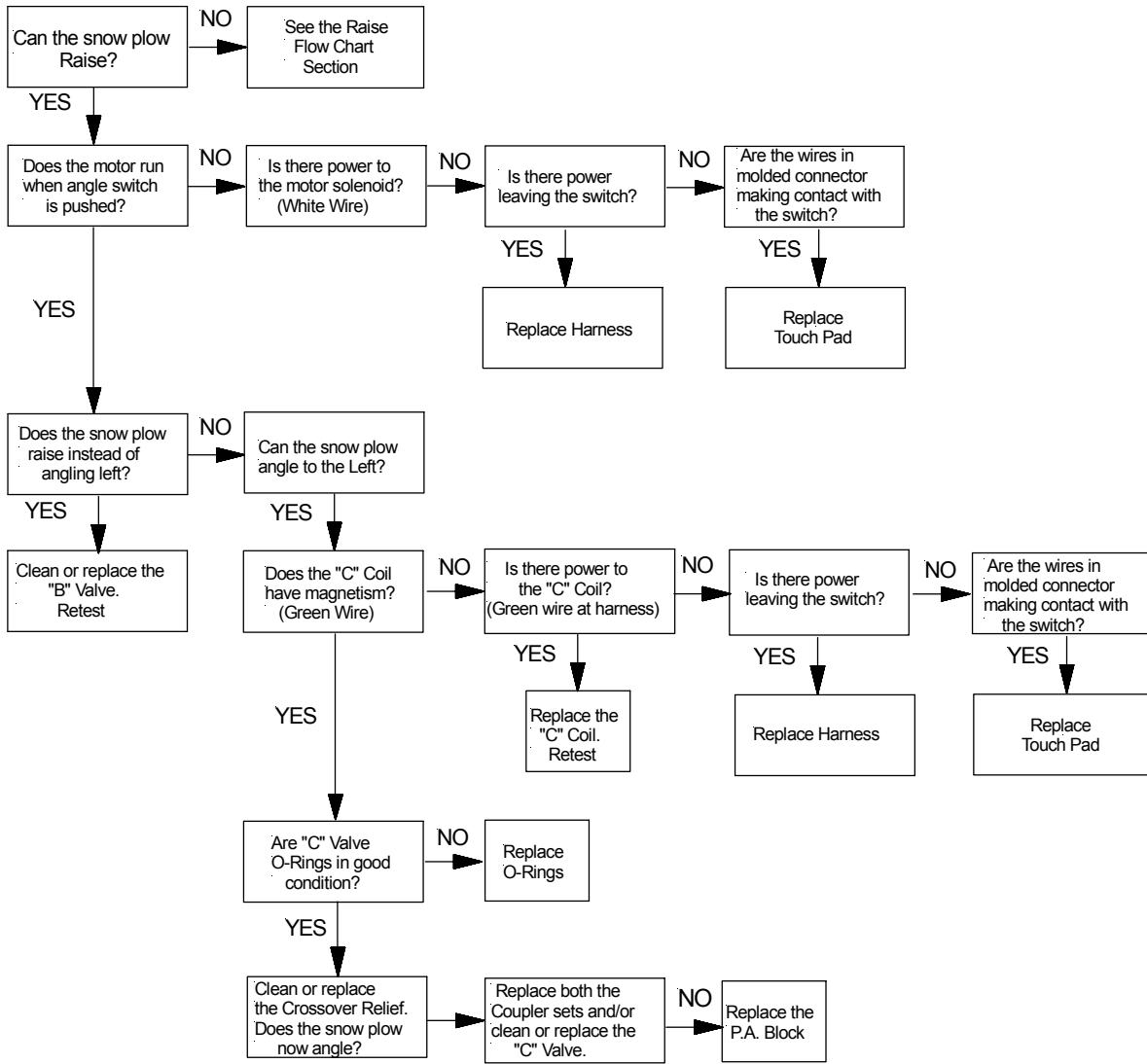

SNOW PLOW WILL NOT HOLD ANGLE

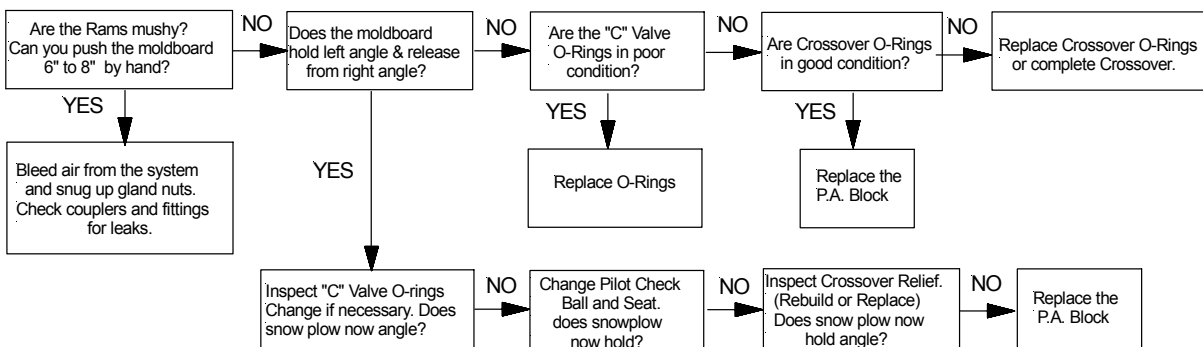

E-58H Wiring

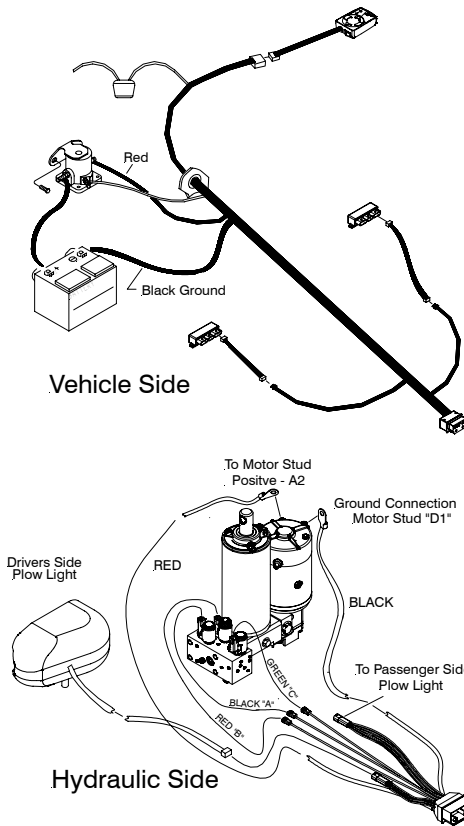

E-68 Wiring

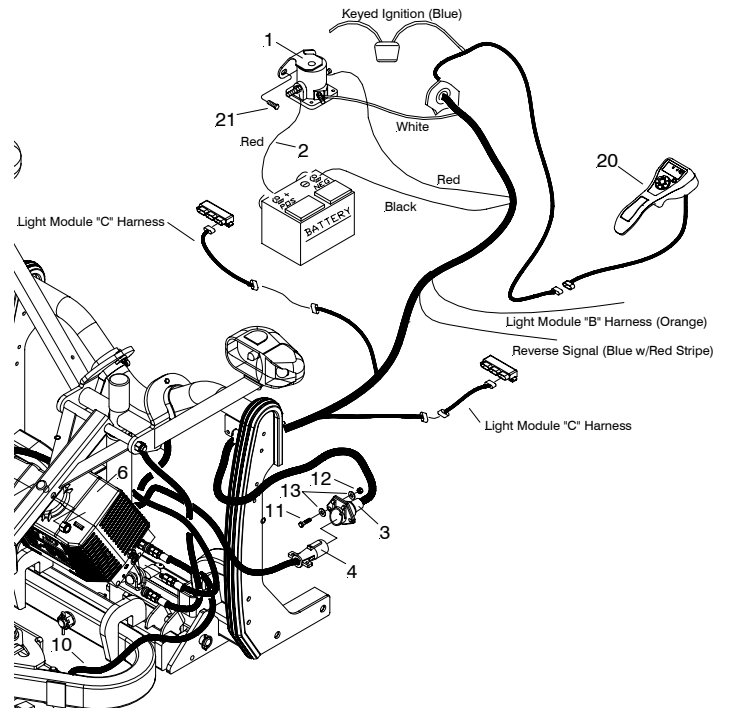

E-78 & E-88 Wiring

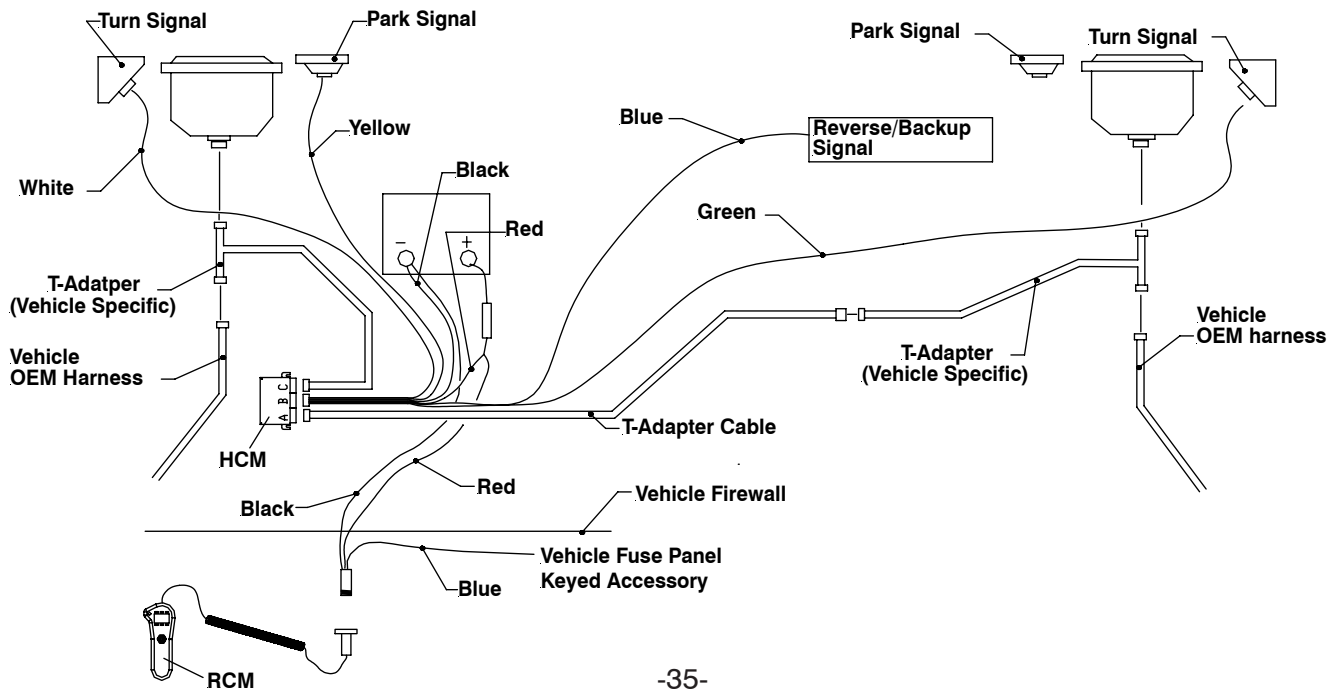

SECTION 3 - REPAIR PROCEDURES

CONTENTS

GENERAL INFORMATION	37		
UNIT DISASSEMBLY AND REASSEMBLY	37		
Disassembly	37		
Reassembly	37		
• Additional Reassembly Points	37		
PUMP	37		
Shaft Seal Replacement	37		
ELECTRO LIFT®	E-68 & E-88	E-58H & E-78	
Exploded View	38	38	
Parts Breakdown	39	39	
Disassembly Photos	40-59	40-59	
Reassembly Photos	59-69	59-69	
CROSSOVER RELIEF VALVE E-58H, E-68, E-78 & E-88			
Disassembly	62-63		
Reassembly	64-67		
BRUSH REPLACEMENT			
Iskra Brush Replacement	69		
SPECIFICATIONS	75		

GENERAL INFORMATION

Using the proper guidelines and precautions, the E-58H, E-68, E-78 & E-88 units are easy to disassemble and reassemble. Figure 3-1 (page 38) is an exploded view which applies to the E-68 & E-88. Figure 3-2 is an exploded view which applies to the E-58H & E-78. It should be used as the primary reference for proper reassembly. Where necessary, this section includes additional information, photographs and illustrations to assure proper and efficient repairs.

UNIT DISASSEMBLY AND REASSEMBLY

Many repair procedures, including removal and replacement of the "A", "B", "C", "D" and "E" Solenoid Valves, can be accomplished without removing the unit from the vehicle. While Figures 3-3 through 3-120 show the unit clamped in a vise, make all possible repairs on the vehicle when possible.

NOTE: Pump Assembly should not be disassembled since it cannot be serviced with the exception of the pressure relief valve (pages 43) and pump shaft seal which is covered separately in this section.

Disassembly

See Figures 3-3 through 3-31 (pages 40-59).

Reassembly

See Figures 3-32 through 3-120 (pages 59-69) for important reassembly points.

See Figures 3-91 through 3-110 (Pages 62-66) for Crossover Relief reassembly.

Additional Reassembly Points

- O-Rings- Coat liberally with hydraulic fluid and position carefully to minimize possibility of damage during assembly.
- Fasteners- Torque all fasteners which are specified to insure proper reliability and prevent damage due to over-tightening.

PUMP

Shaft Seal Replacement

NOTE: Do not disassemble pump assembly.

1. Remove motor as shown in Figures 3-13 and 3-14 (page 42).
2. Using an appropriate tool, pry out the original shaft seal, being careful not to damage the shaft or pump housing.
3. Liberally coat the replacement seal I.D. with hydraulic fluid and apply a very light film of Permatex Form-A-Gasket No. 2 or equivalent to the replacement seal O.D.
4. Carefully slide the replacement seal (metal side up) over the shaft until it is squarely against the pump housing.
5. Center a 11/16" hex deep socket over the seal and use it and a plastic or leather mallet to squarely drive the seal into the pump.
6. Replace the motor as shown in Figures 3-88 & 3-89 (page 61).

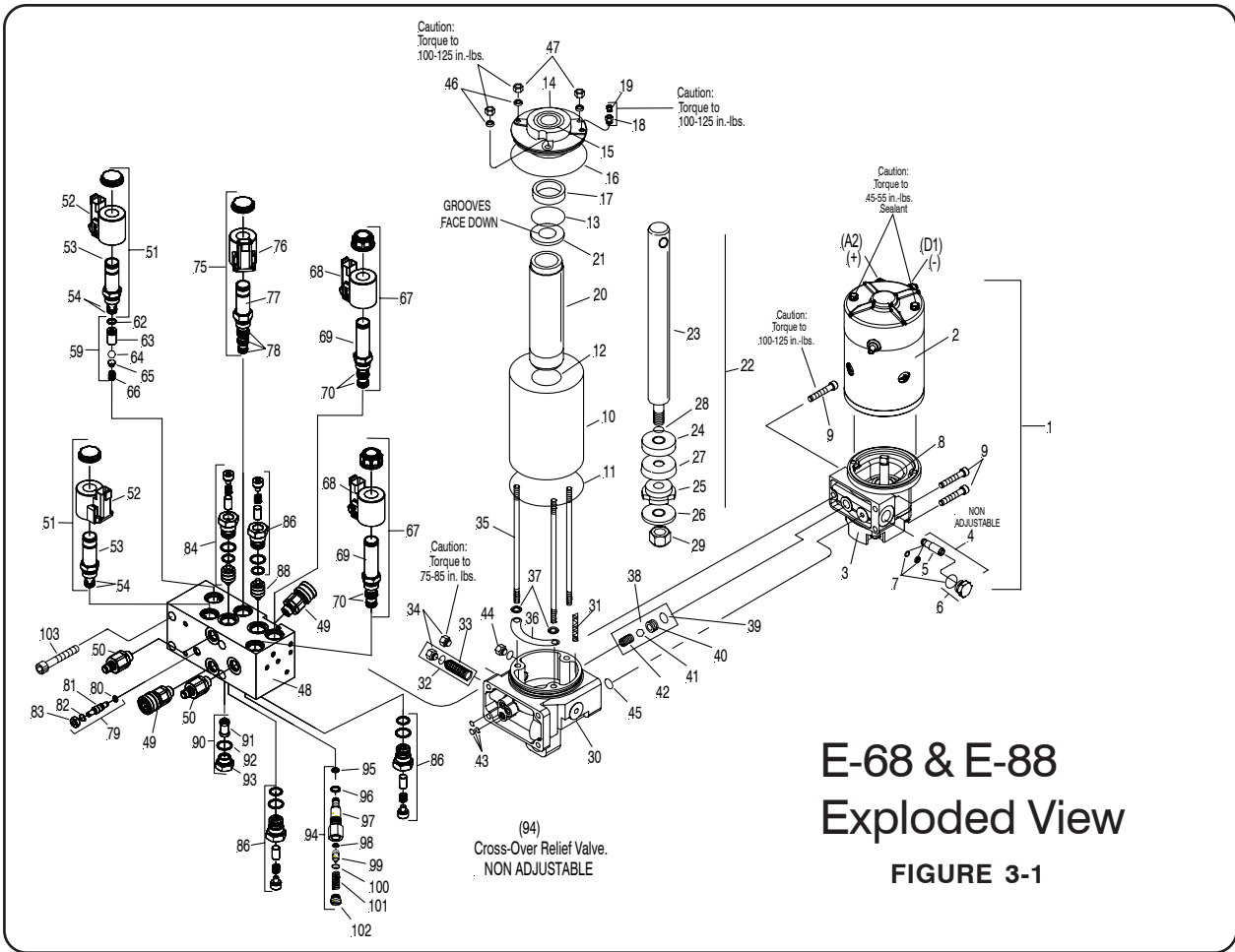

**E-68 & E-88
Exploded View**
FIGURE 3-1

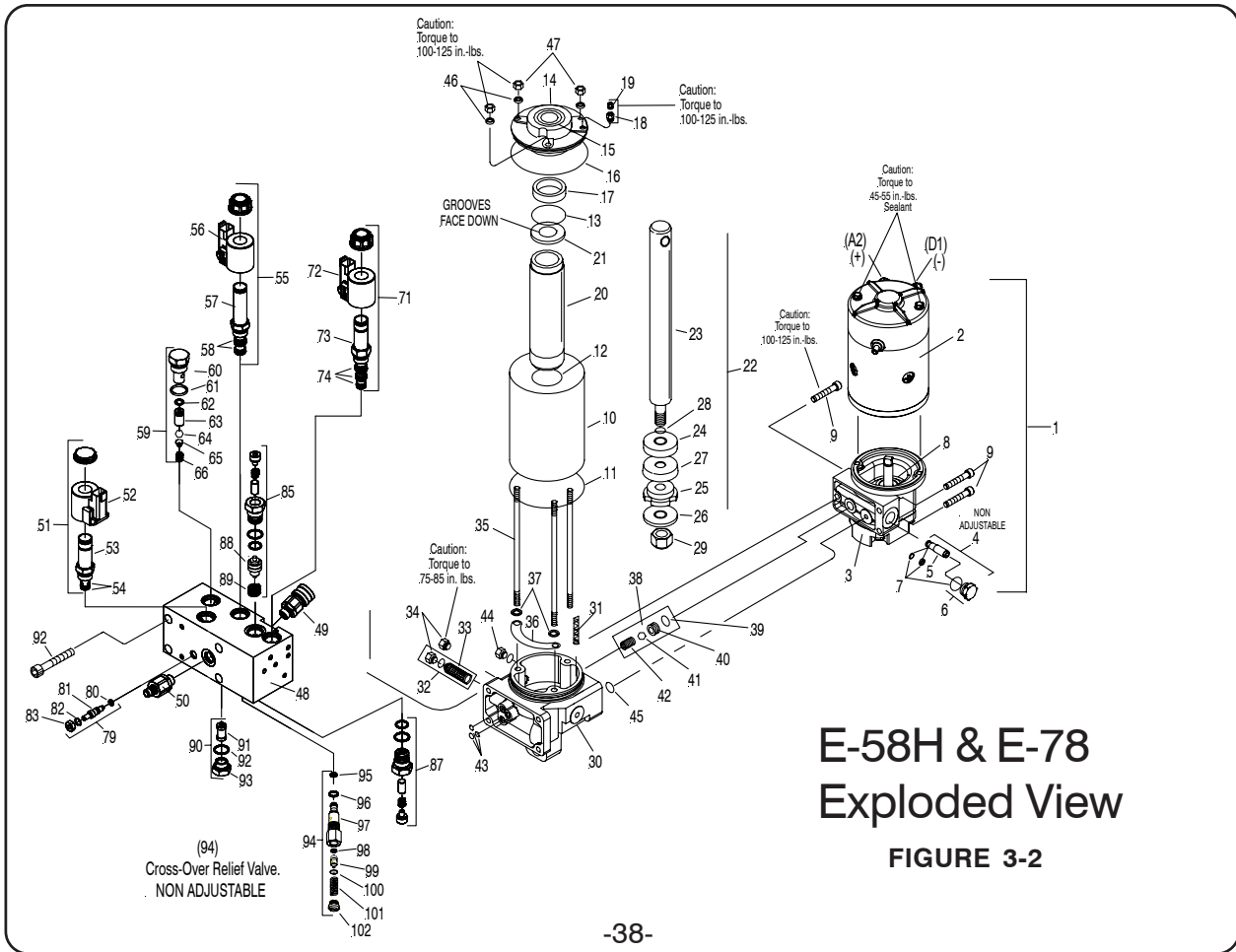

**E-58H & E-78
Exploded View**
FIGURE 3-2

PARTS BREAKDOWN

PARTS LIST

ITEM	All	QTY	DESCRIPTION
1	15869	1	Pump & Motor Assy. (12 volt)
2	15727	1	• Motor - 12 Volt (2 Terminal)
3	15889	1	• Pump Assy.
4	15874	1	••Kit - Pump Relief Valve
5	15870	1	•• Relief Valve Assy.
6	15878	1	•• Plug w/O-Ring
7*	15875	1	Seal Kit Relief Valve
8	15877	1	Pump Shaft Seal
9	22339	3	Soc. Head 5/16-18 x 1-3/4"
10	15204	1	Cylinder Tank
11*	15131	1	O-Ring 3-1/2 I.D.
12*	15163	1	O-Ring 1-15/16 I.D.
13*	15198	1	O-Ring 1-1/8 I.D.
14	15738	1	Cover & Seal Assy.
15*	05119	1	• Wiper
16*	15131	1	• O-Ring 3-1/2 I.D.
17	15737	1	• Sleeve
	08473	1	Pressure Relief Valve Kit
18	21805	1	• Reducer Bushing 1/4 x 1/8
19	21806	1	• Pressure Relief Valve
20	15205	1	Cylinder
21	15209	1	Washer (Grooves Down)
22	15761	1	Ram Assembly
23	15206	1	• Ram
24	15158	1	• Piston
25	15219	1	• Piston Follower
26	15760	1	• Spacer
27*	15162	1	• Packing Cup
28*	15125	1	• O-Ring 7/16 I.D.
29	20316	1	• Locknut 1/2-13
30	15980	1	Base & Strainer Assy.
31	15326	1	• Strainer
32	15641	1	• Filter Kit - 9/16"
33	15619	1	•• Filter
34	21999	1	•• Plug w/O-Ring - 9/16"
35	15203	3	Stud
36	15621	1	Baffle
37	21980	2	Retainer Ring
38	15574	1	Pump Check Valve Kit
39*	15124	1	• O-Ring 3/8 I.D.
40	15354	1	• Seat
41	15603	1	• Ball, 9/32
42	15604	1	• Spring
43*	15122	3	O-Ring 1/4 I.D.
44	21999	2	Drain Plug w/O-Ring - 9/16"
45*	15127	1	O-Ring 5/8 I.D.
46*	21929	3	Washer, Nyltite 5/16
47	20697	3	Locknut 5/16 - 24

Parts indented are included in assembly under which they are indented.

*Parts included in Master Seal Kit Part No. 15969 (E-58H & E-78), 15978 (E-68 & E-88)

Basic Seal Kit Part No. 15254

Pump Relief Valve @ 2000 ± 50 P.S.I. full flow. **Non Adjustable**

Crossover Relief Valve @ 3800 ± 400 P.S.I. @ 2-1/2 G.P.M. **Non Adjustable**

ITEM	E-58H & E-78	E-68 & E-88	QTY	DESCRIPTION
48	15612	15941	1	• Valve Assy. w/Coup. (12V)
49	-----	22445	2	• Coupler, Female Half
49	22445	-----	1	• Coupler, Female Half
50	-----	22442	2	• Coupler, Male Half
50	22442	-----	1	• Coupler, Male Half
51	15925	15925	1	"A" Solenoid Assembly
52	15916	15916	1	•• Coil (12V)
53	15917	15917	1	•• "A" Cartridge Valve
54	15928	15928	1	••• Seal Kit, "A" Valve
55	15926	15925	1	"B" Solenoid Assembly
56	15916	15916	1	•• Coil (12V)
57	15918	15917	1	•• "B" Cartridge Valve
58	15929	15928	1	••• Seal Kit, "B" Valve
59	15959	15959	1	• Kit- "B" Check Valve
60	-----	-----	1	•• "B" Check Valve Nut
61	-----	-----	1	•• O-ring
62	-----	-----	1	•• O-ring
63	-----	-----	1	•• "B" Valve Check Body
64	-----	-----	1	•• "B" Valve Check Ball
65	-----	-----	1	•• Ball holder
66	-----	-----	1	•• Spring
67	-----	15926	2	"C" & "D" Solenoid Assembly
68	-----	15916	1	•• Coil (12V)
69	-----	15918	1	•• "C" & "D" Cartridge Valve
70	-----	15929	1	••• Seal Kit "C" & "D" Cartridge
71	15987	-----	2	"C" Solenoid Assembly
72	15916	-----	1	•• Coil (12V)
73	15958	-----	1	•• "C" Cartridge Valve
74	15930	-----	1	••• Seal Kit "C" Cartridge
75	-----	15927	1	"E" Solenoid Assembly
76	-----	15916	1	•• Coil (12V)
77	-----	15919	1	•• "E" Cartridge Valve
78	-----	15930	1	••• Seal Kit "E" Cartridge
79	15950	15950	1	Kit Needle Valve (Lower Adj.)
80	-----	-----	1	• O-ring
81	-----	-----	1	• Needle Valve
82	-----	-----	1	• Needle Valve Retaining Ring
83	-----	-----	1	• Nut M6 x 1/2" nut
84	-----	15965	2	• Kit Dual PO Check Valve
85	15965	-----	1	• Kit Dual PO Check Valve
86	-----	15944	2	•• Check Valve Assembly
87	15944	-----	2	•• Check Valve Assembly
88	15943	15943	1	•• P.O. Pilot Spool
89	15999	-----	1	•• Spring
90	15951	15951	1	Kit P.A. Block Filter
91	15936	15936	1	• Tank Filter
92	15938	15938	1	• O-ring
93	15937	15937	1	• M16 x 1 Filter Cap
94	15974	15974	1	• Kit-Crossover Valve
95	-----	-----	1	•• O-ring
96	-----	-----	1	•• O-ring
97	-----	-----	1	•• Body
98	-----	-----	1	•• O-ring w/Glyd. Ring
99	-----	-----	1	•• Poppet
100	-----	-----	1	•• Washer
101	-----	-----	1	•• Spring
102	-----	-----	1	•• Plug
*	15975	15975	1	•• Seal Kit-Crossover Valve (includes items 95,96,98)
103	21826	21826	4	Soc. Head 5/16-18 x 1-1/2"

DISASSEMBLY - E-78 & E-88



FIGURE 3-3
Remove two phillips head screws from the front cover.

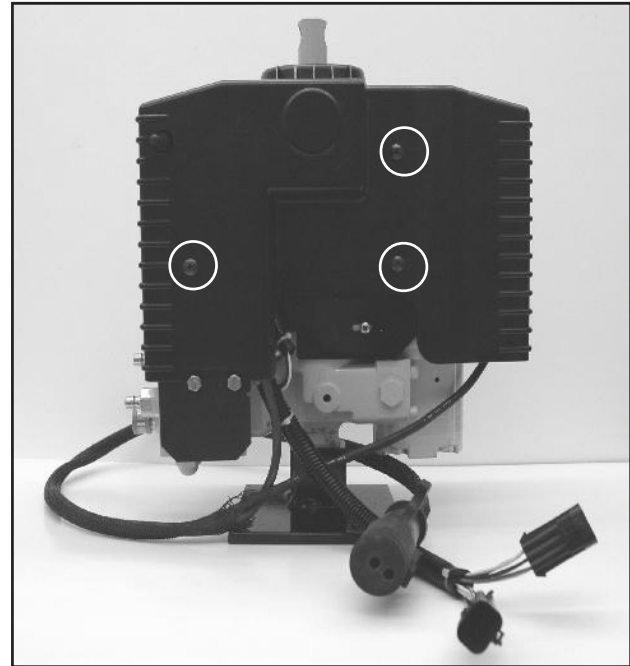

FIGURE 3-4
Remove three phillips head screws from the rear cover.

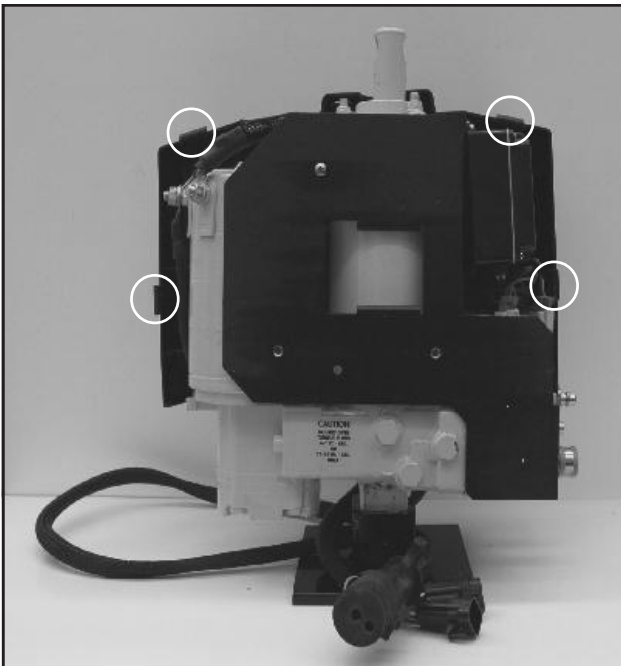

FIGURE 3-5
Carefully press in the four tabs holding the front and rear covers together and pill the covers apart.

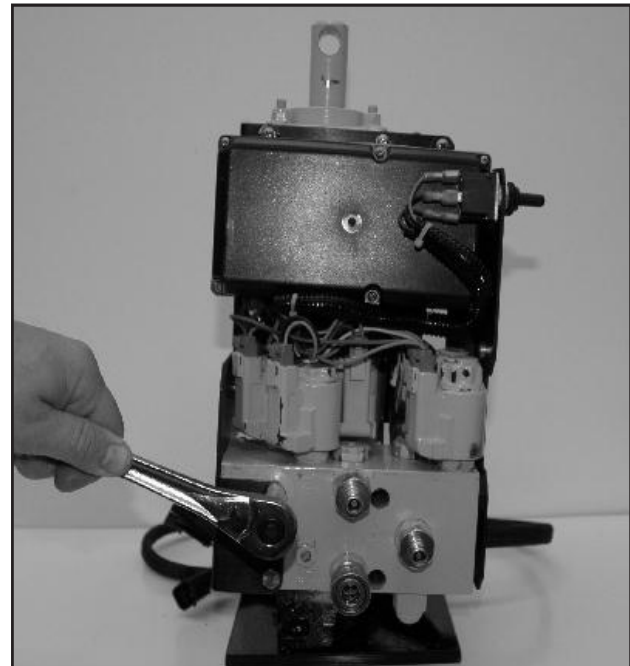

FIGURE 3-6
Remove two 1/4" bolts using a 7/16" Socket or wrench.

DISASSEMBLY - E-78 & E-88

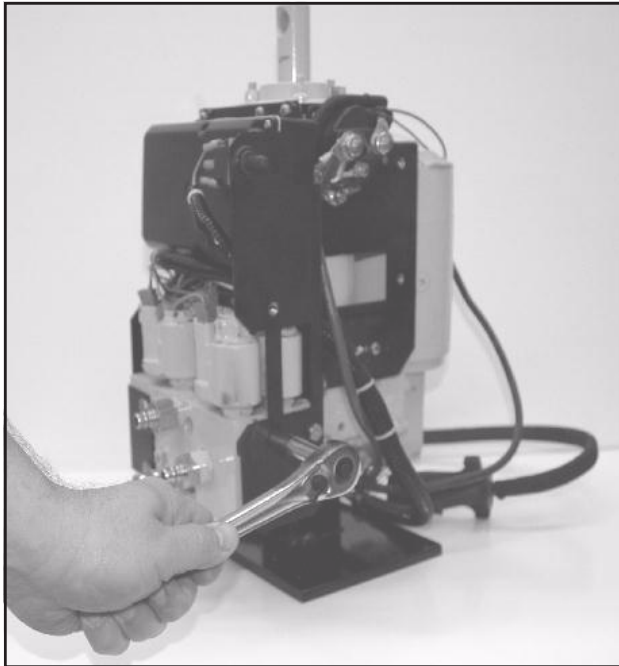

FIGURE 3-7

Remove two 1/4" bolts using a 7/16" Socket or wrench. Retain Spacer Plate between bracket and block.



FIGURE 3-8

Using a 1/2" Socket or Wrench remove the two bolts holding the positive and negative wires to the motor.

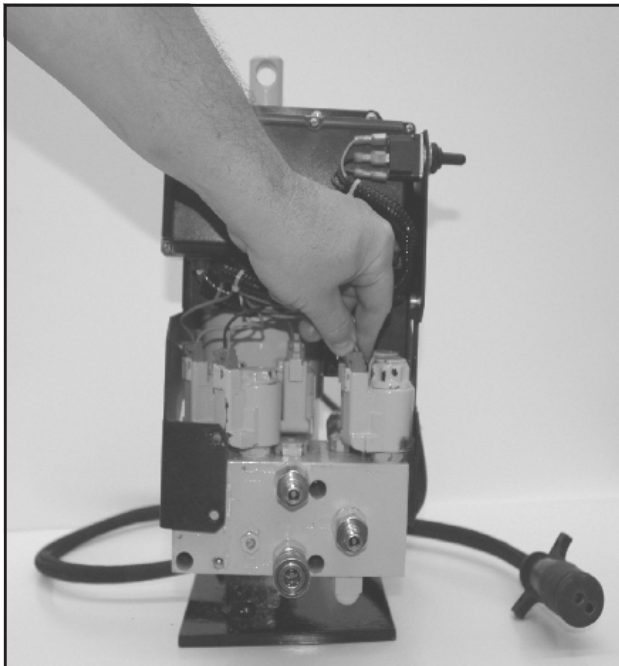

FIGURE 3-9

Gently pull up on electronic framing until coil wire plugs are accessible. Remove all coil wire plugs. (E-88 will have five and the E-78 will only have three coil wire plugs)

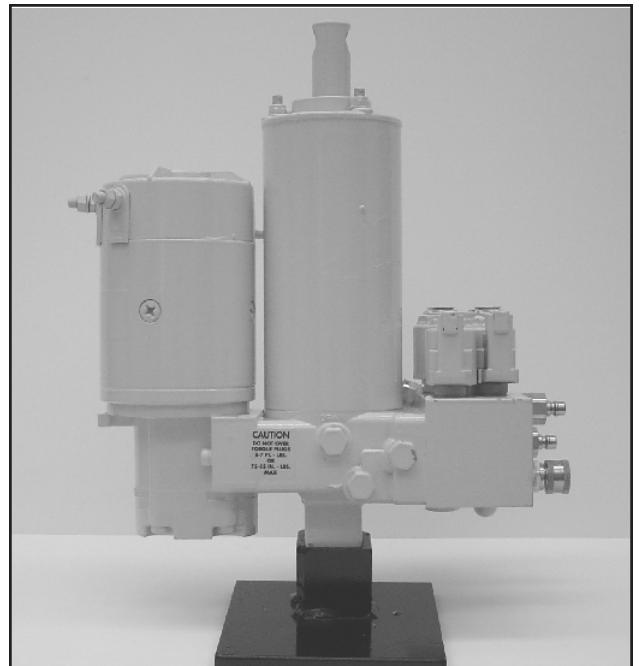

FIGURE 3-10

Now both the E-78 and E-88 hydraulic units are accessible.

DISASSEMBLY - ALL MODELS

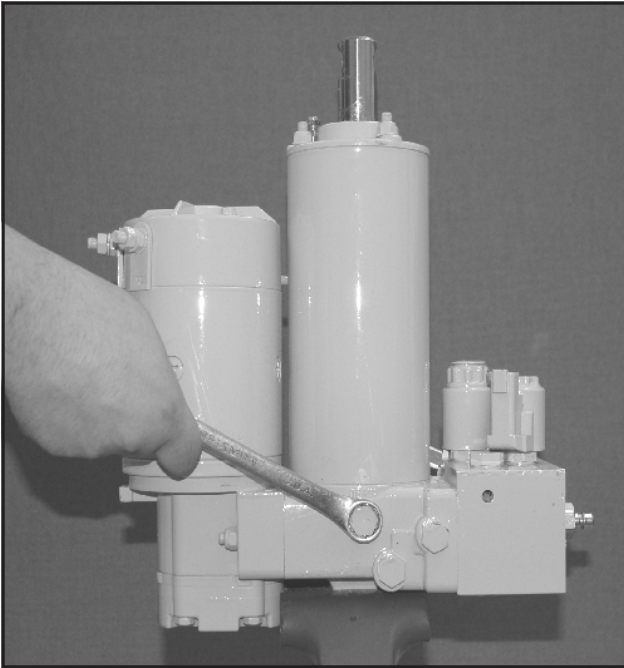

FIGURE 3-11

To drain oil from the unit, remove the drain plug using a 11/16" wrench.

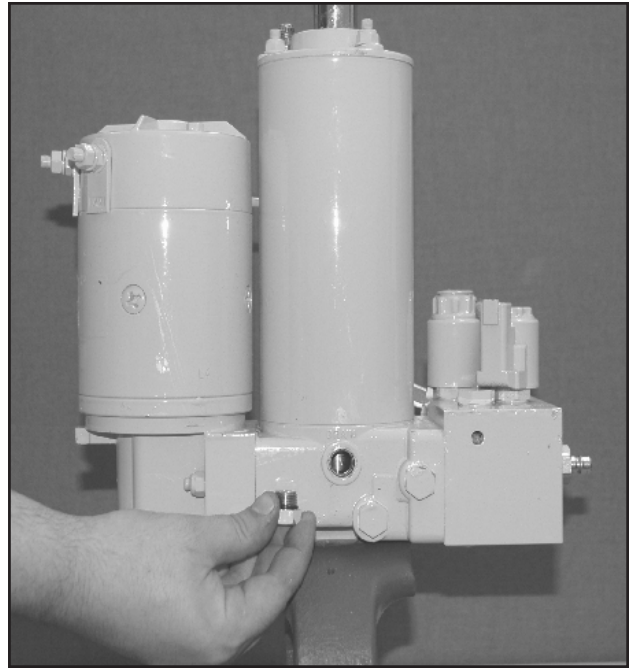

FIGURE 3-12

Drain Plug removed.

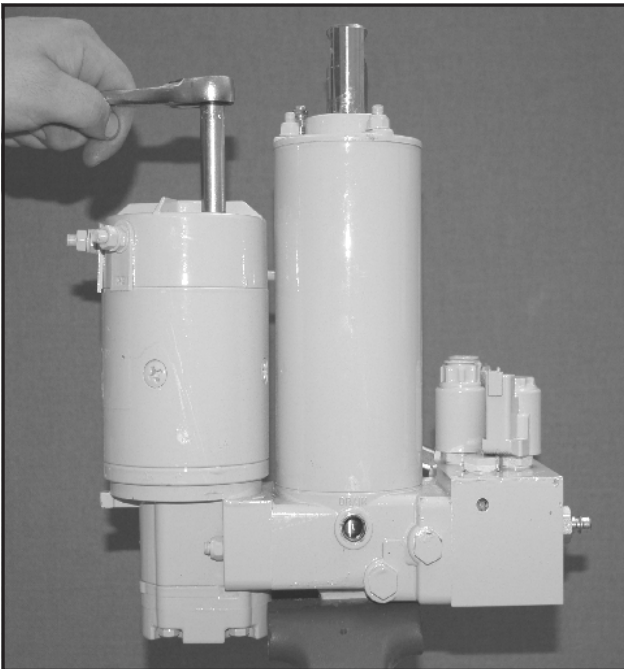

FIGURE 3-13

To replace the motor remove the two cap screws, use a 10mm hex socket.

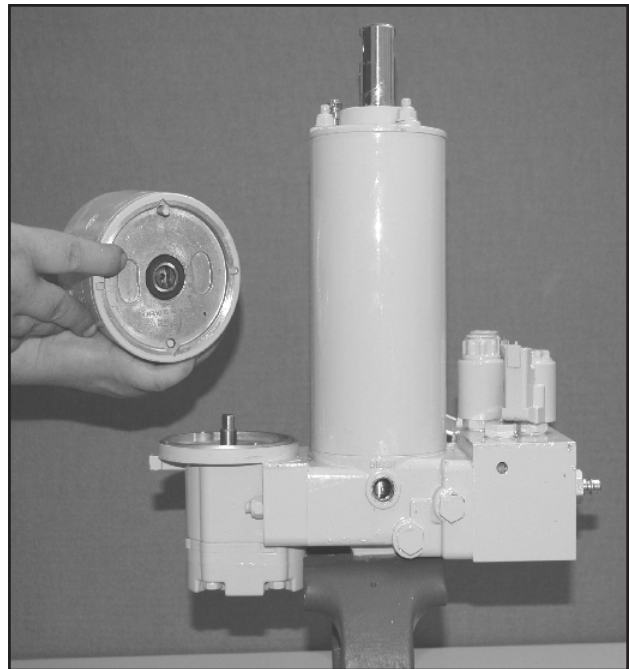

FIGURE 3-14

Hold the motor parts together while removing it from the pump.

DISASSEMBLY - ALL MODELS

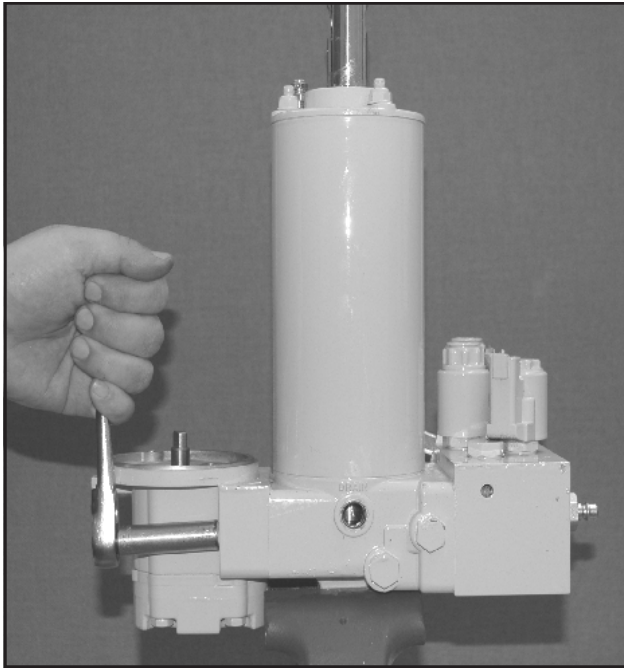

FIGURE 3-15

To remove the pump, Use a 1/2" hex socket on the three locknuts. The studs usually unscrew with the nuts.

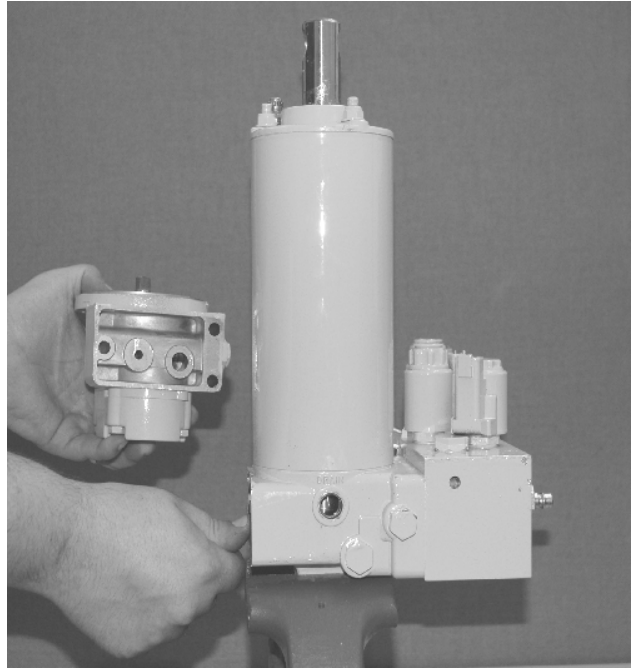

FIGURE 3-16

Pump removed from the unit base.

E-68 & E-88 ONLY

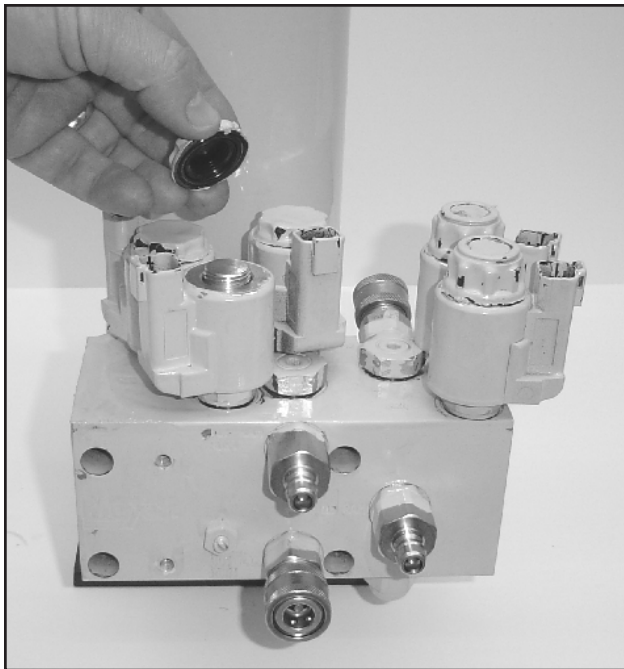

FIGURE 3-17

Remove the "A" Coil using your hand or carefully use pliers.

E-68 & E-88 ONLY

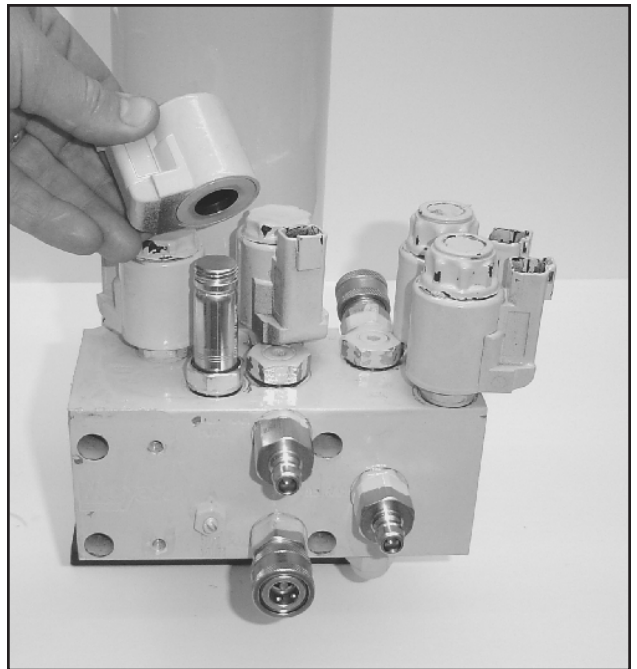

FIGURE 3-18

Coil removed from the "A" Cartridge.

DISASSEMBLY - E-68 & E-88 ONLY

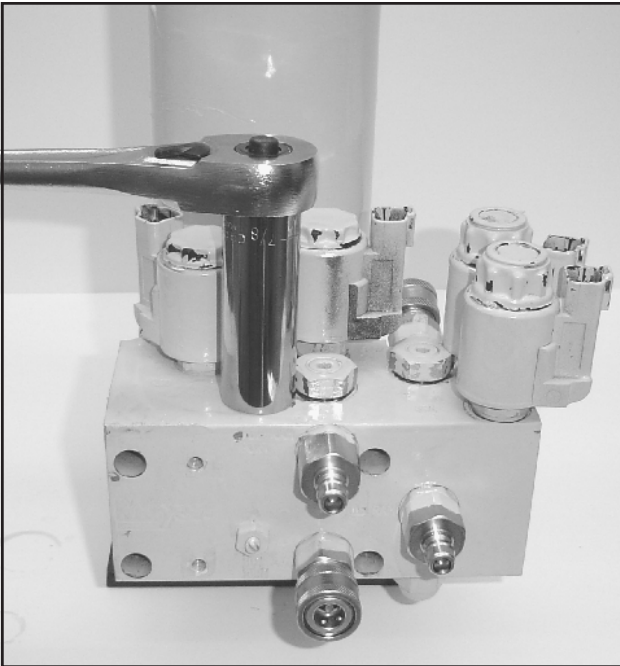

FIGURE 3-19

The "A" Cartridge is removed using a 7/8" hex deep socket.

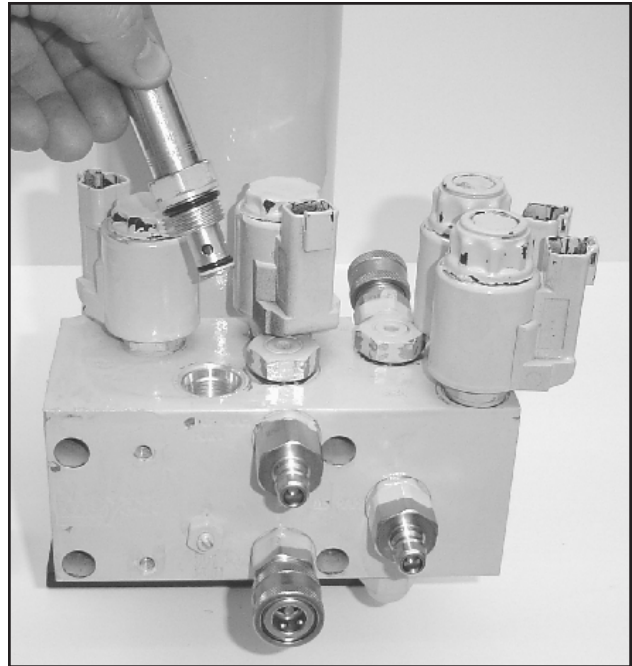

FIGURE 3-20

The "A" Cartridge is removed. Clean by soaking cartridge in cleaning solvent.

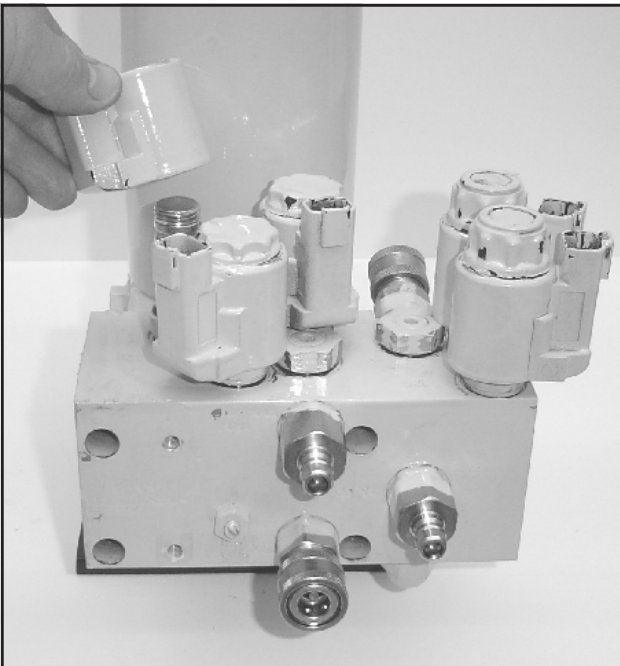

FIGURE 3-21

Remove the "B" Coil.

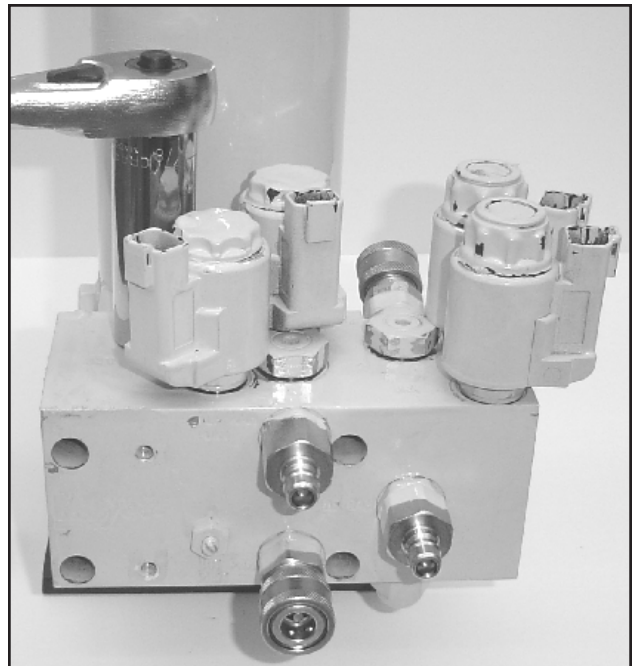

FIGURE 3-22

The "B" Cartridge is removed using a 7/8" hex deep socket.

DISASSEMBLY - E-68 & E-88 ONLY

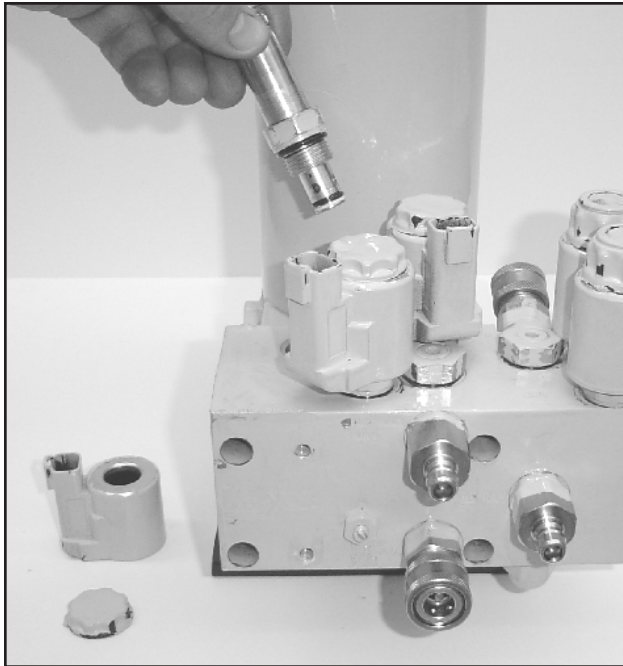

FIGURE 3-23

The "B" Cartridge is removed. Clean by soaking cartridge in cleaning solvent.

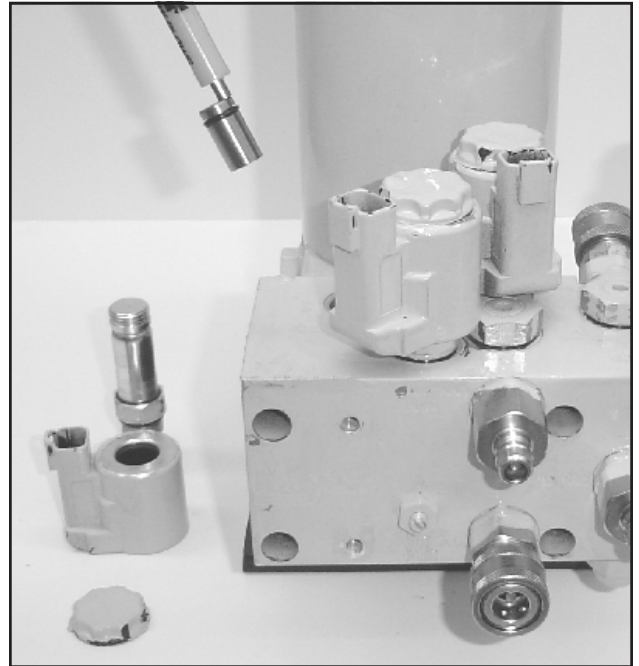

FIGURE 3-24

A magnetic probe is extremely useful for removal of small valve parts. Use a magnet to retrieve the "B" Check Valve Body.

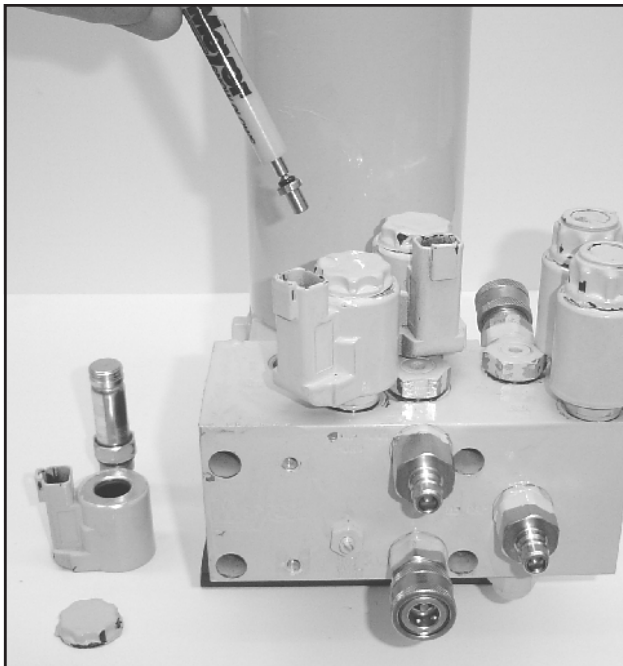

FIGURE 3-25

Use a magnet to retrieve the "B" Check Valve Poppet. The "B" Check valve poppet has been replaced by a ball. (See Service Bulletin 214) The "B" Check valve replacement kit is part number 15959.

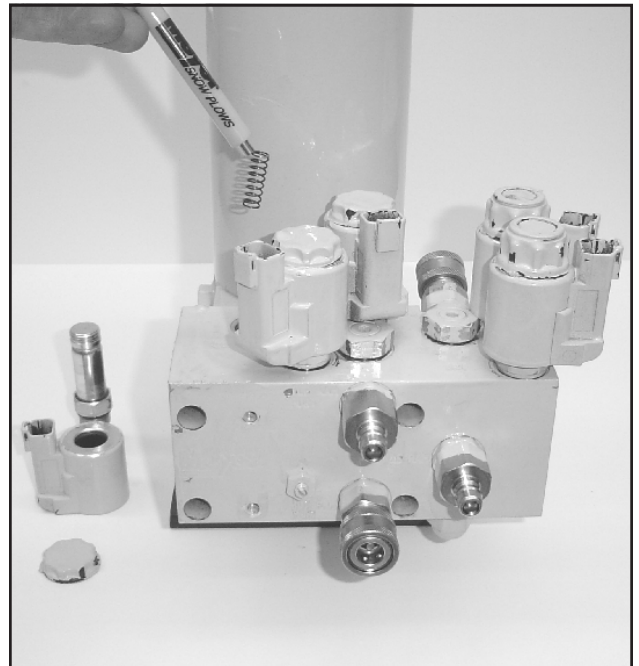

FIGURE 3-26

Use a magnet to retrieve the "B" Check Valve Spring.

DISASSEMBLY - E-68 & E-88 ONLY

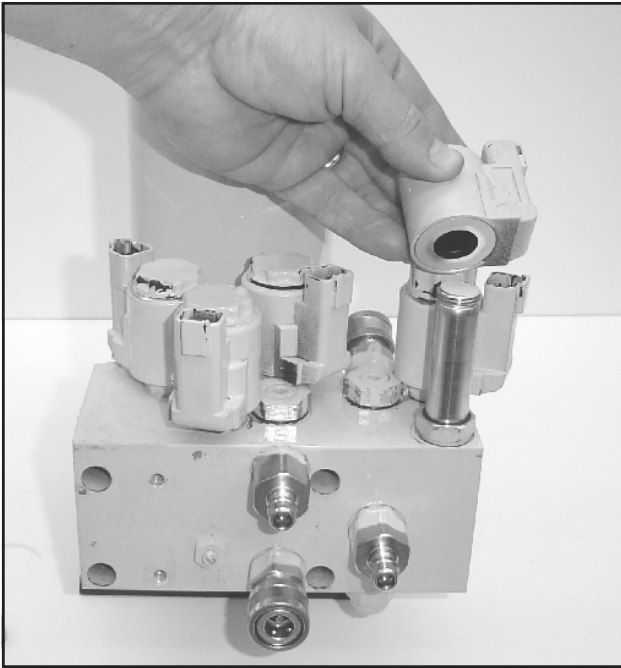

FIGURE 3-27
Remove the "C" Coil.

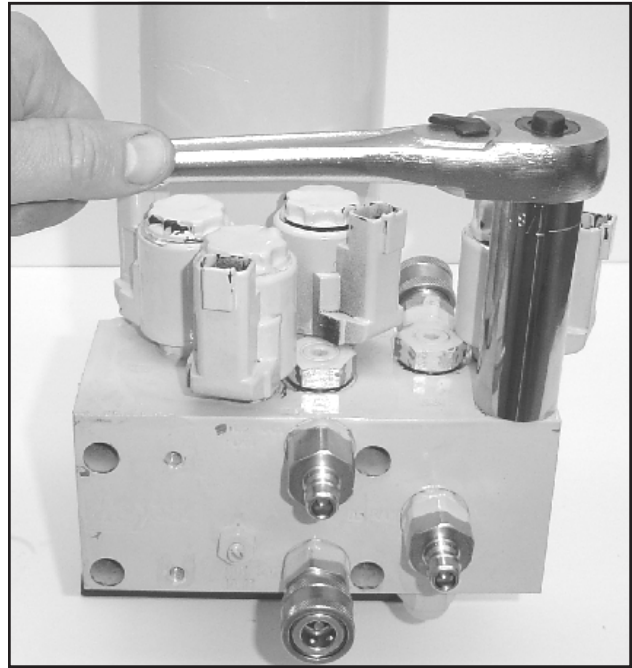

FIGURE 3-28
The "C" Cartridge is removed using a 7/8" hex deep socket.

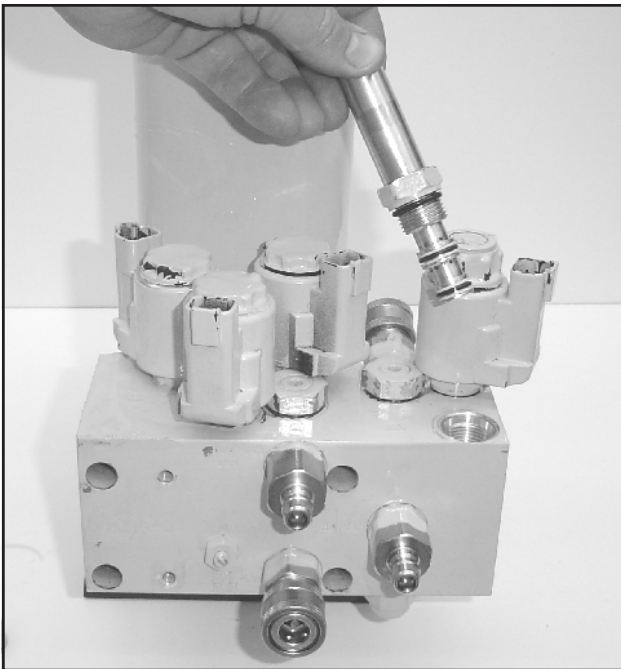

FIGURE 3-29
The "C" Cartridge is removed. Clean by soaking cartridge in cleaning solvent.

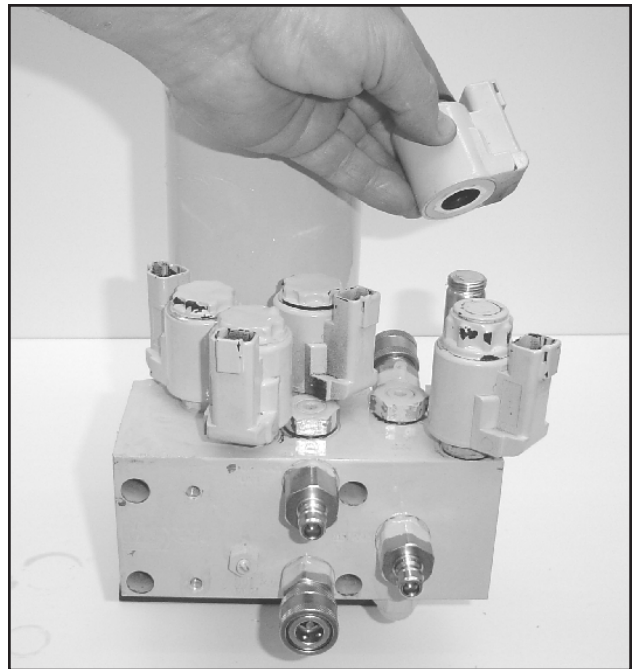

FIGURE 3-30
Remove the "D" Coil.

DISASSEMBLY - E-68 & E-88 ONLY

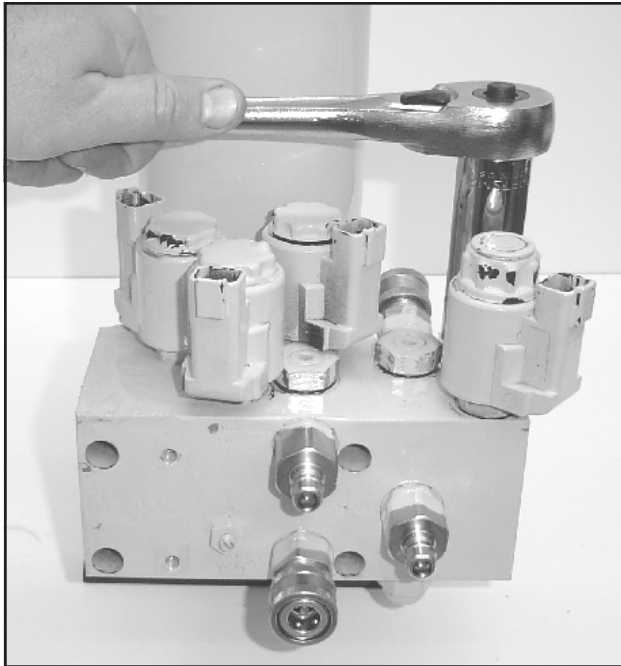

FIGURE 3-31

The "D" Cartridge is removed using a 7/8" hex deep socket.

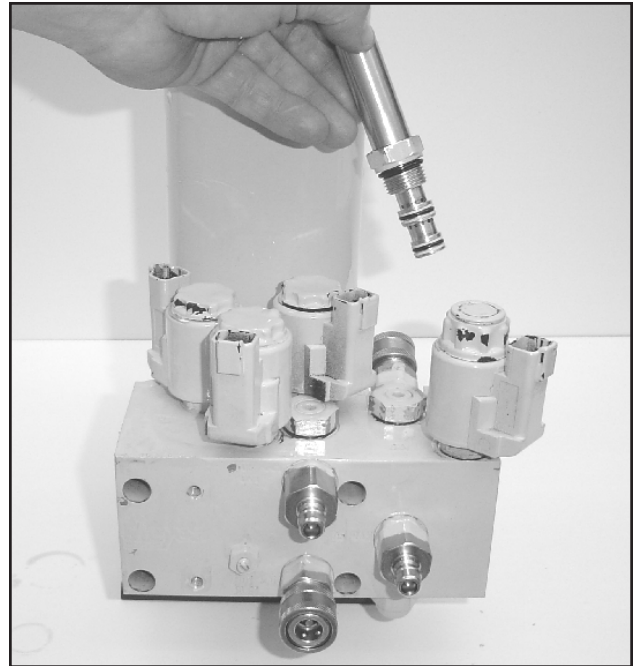

FIGURE 3-32

The "D" Cartridge is removed. Clean by soaking cartridge in cleaning solvent.

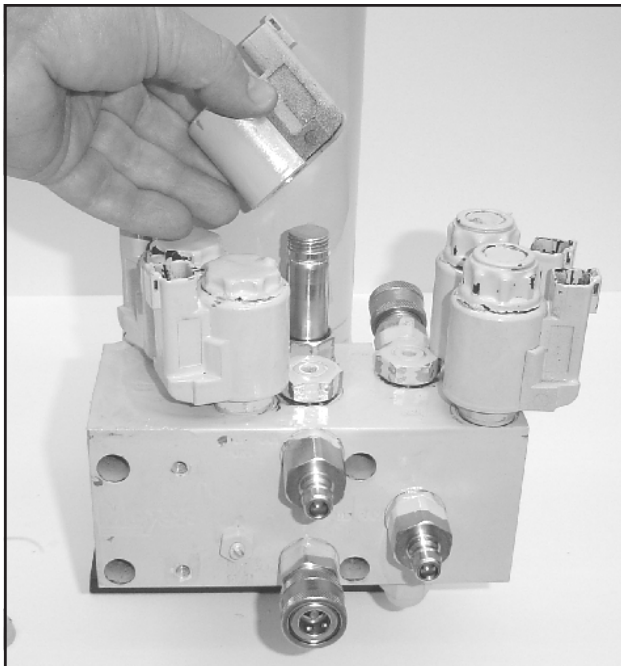

FIGURE 3-33

Remove the "E" Coil.

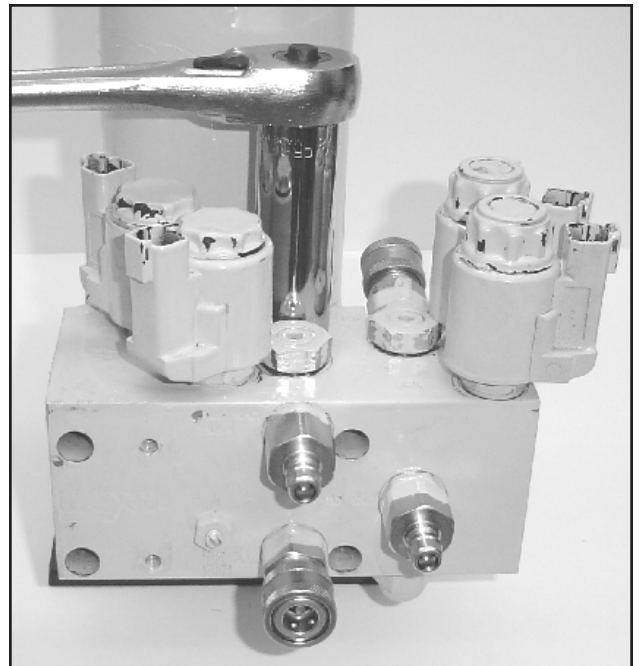

FIGURE 3-34

The "E" Cartridge is removed using a 7/8" hex deep socket.

DISASSEMBLY - E-68 & E-88 ONLY

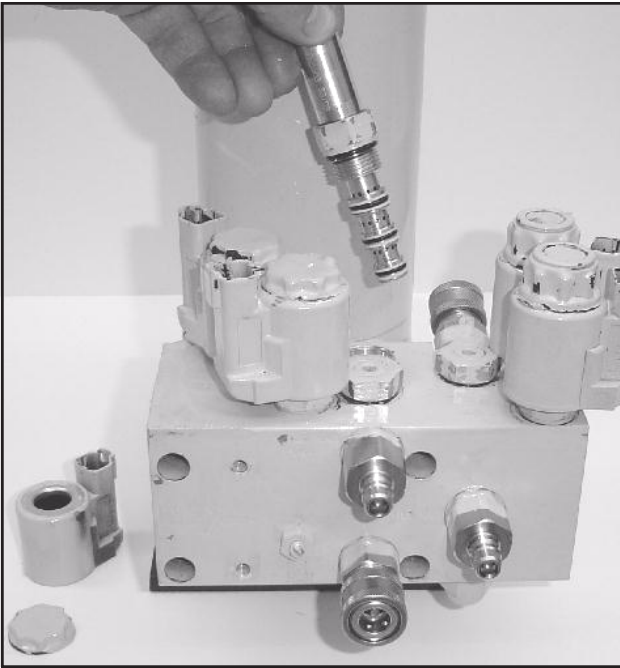

FIGURE 3-35

The "E" Cartridge is removed. Clean by soaking cartridge in cleaning solvent.

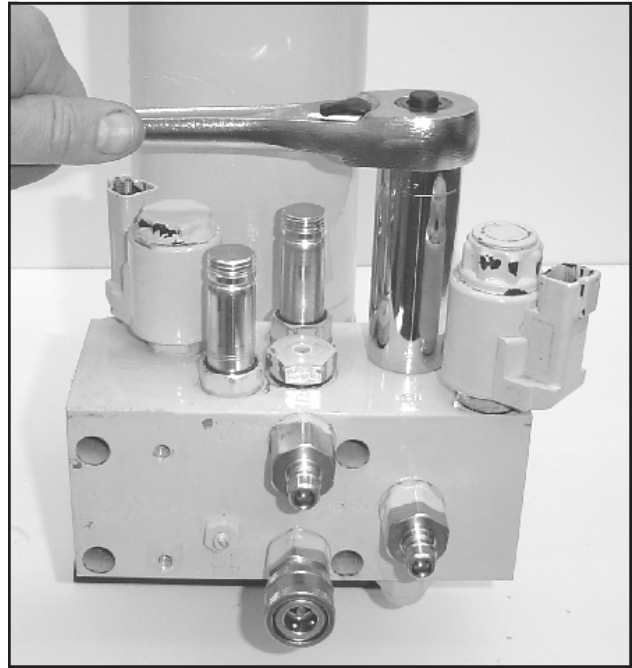

FIGURE 3-36

Use a 15/16" hex deep socket to remove the P.O. Check valve assembly used for angling.

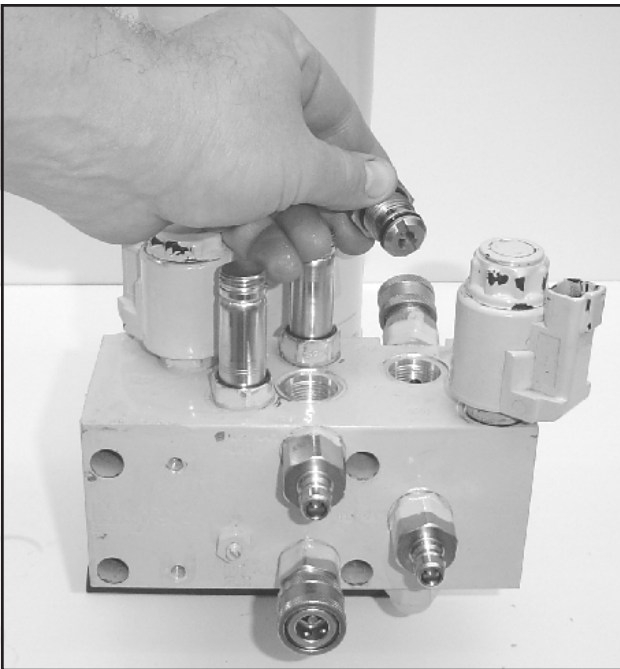

FIGURE 3-37

Remove the P.O. Check valve assembly. Clean by soaking Check valve in cleaning solvent.

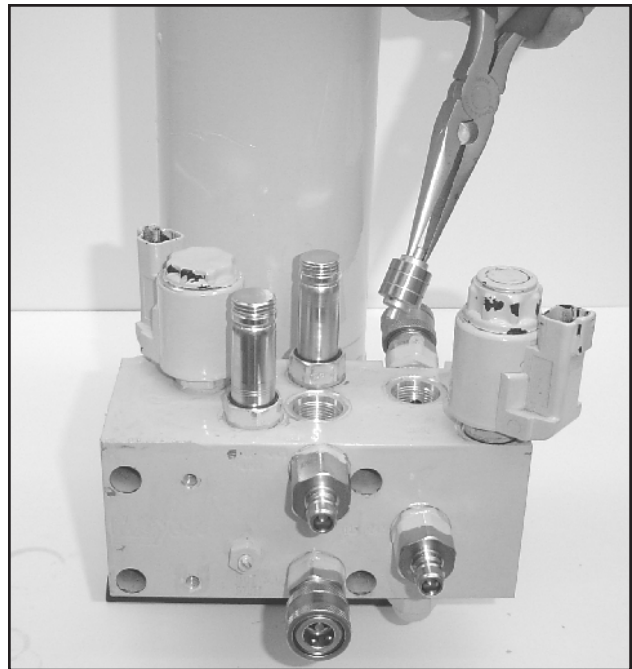

FIGURE 3-38

Use needle nose pliers to remove the P.O. Pilot Piston.

DISASSEMBLY - E-68 & E-88 ONLY

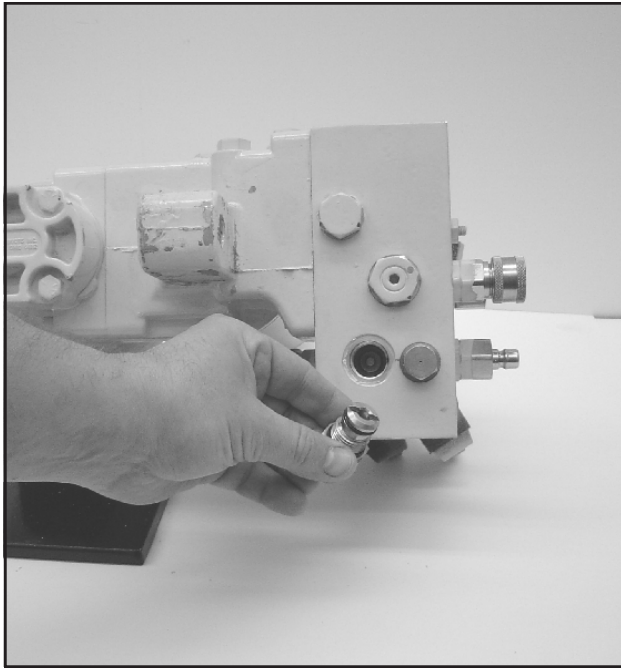

FIGURE 3-39

Use a 15/16" hex deep socket to remove the P.O. Check valve assembly from the bottom of the valve block. Clean by soaking Check valve in cleaning solvent.

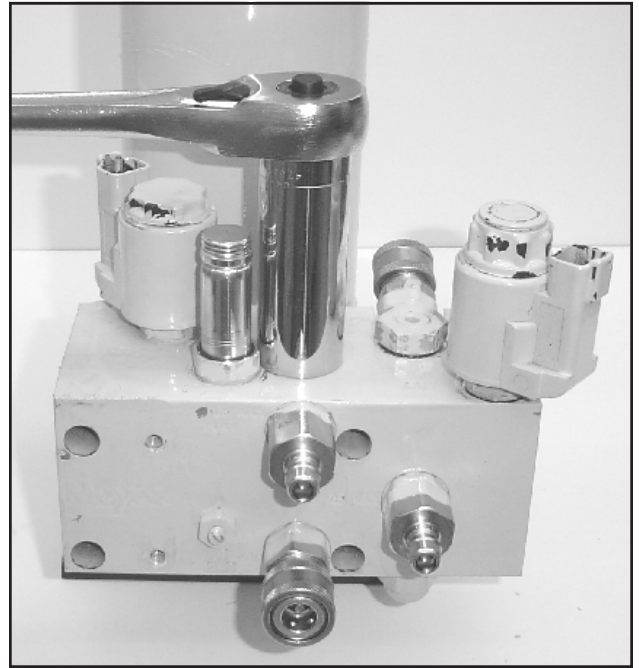

FIGURE 3-40

Use a 15/16" hex deep socket to remove the P.O. Check valve assembly used for mount/dismount.

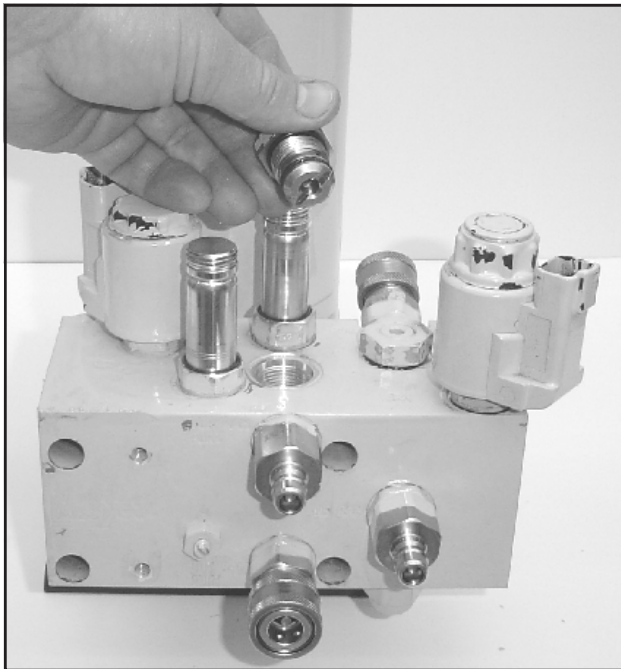

FIGURE 3-41

Remove the P.O. Check valve assembly. Clean by soaking Check valve in cleaning solvent.

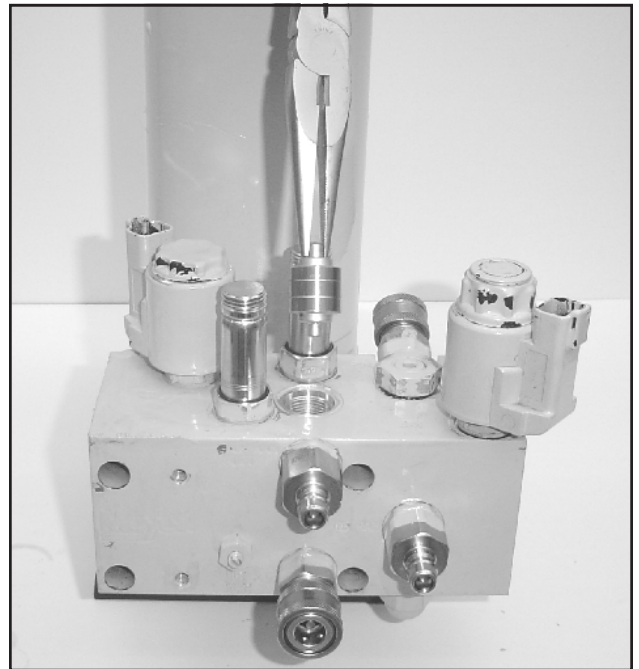

FIGURE 3-42

Use needle nose pliers to remove the P.O. Pilot Piston.

DISASSEMBLY - E-68 & E-88 ONLY

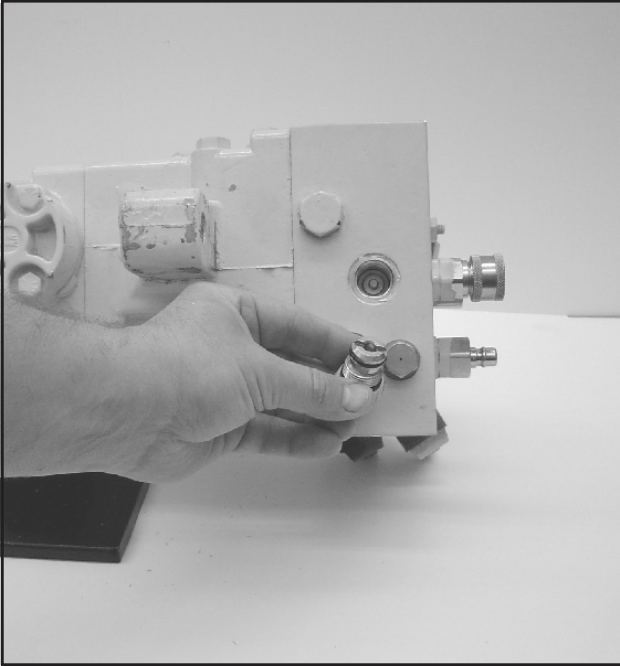

FIGURE 3-43

Use a 15/16" hex deep socket to remove the P.O. Check valve assembly from the bottom of the valve block. Clean by soaking Check valve in cleaning solvent.

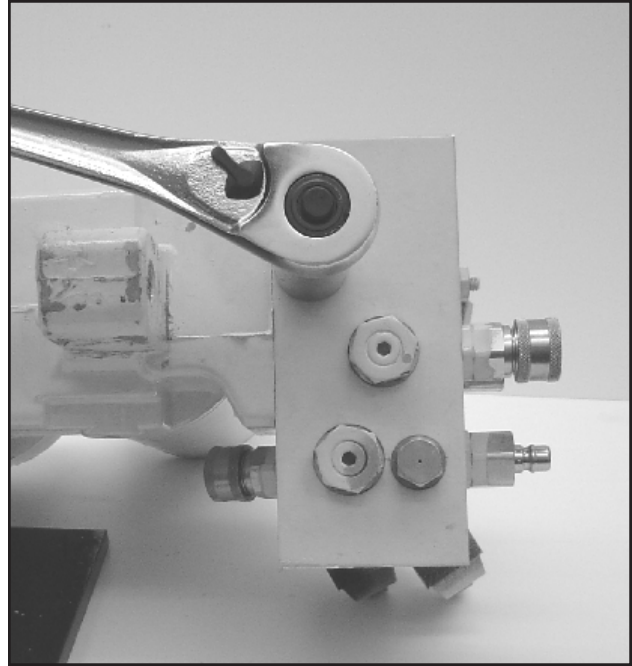

FIGURE 3-44

Use a 7/8" wrench or socket to remove filter plug.

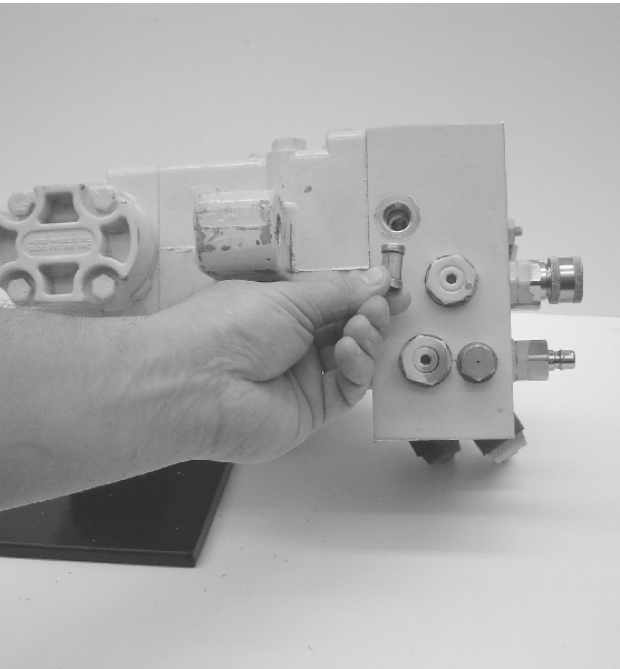

FIGURE 3-45

Remove the Filter. Clean by soaking Filter in cleaning solvent.

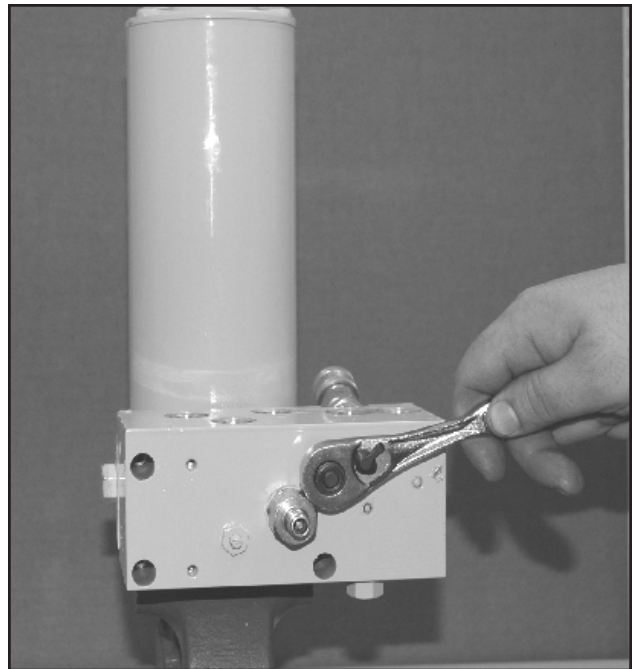

FIGURE 3-46

Use a 1/4" hex key or Allen Socket to remove the four valve block mounting bolts.

DISASSEMBLY - E-58H & E-78 ONLY

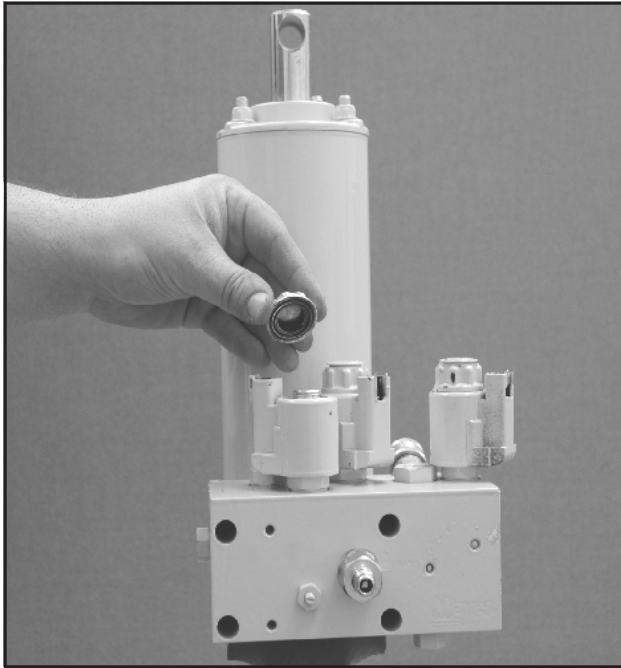

FIGURE 3-47

Remove the "A" Coil using your hand or carefully use pliers.

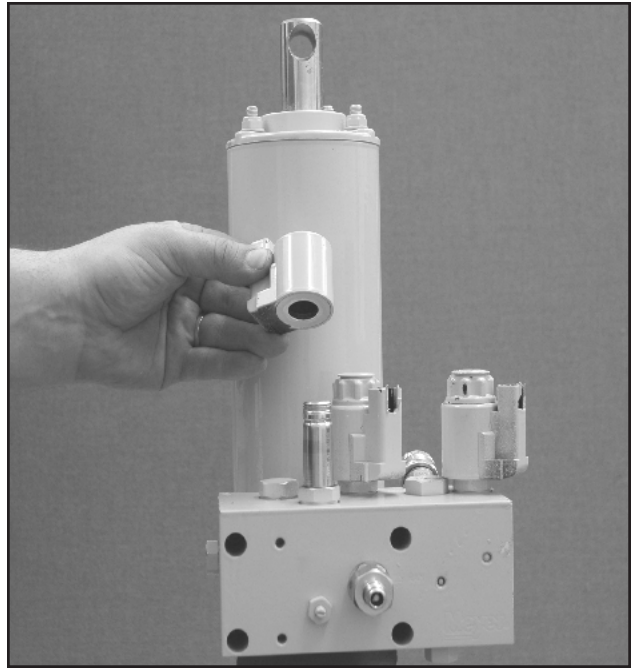

FIGURE 3-48

Coil removed from the "A" Cartridge.

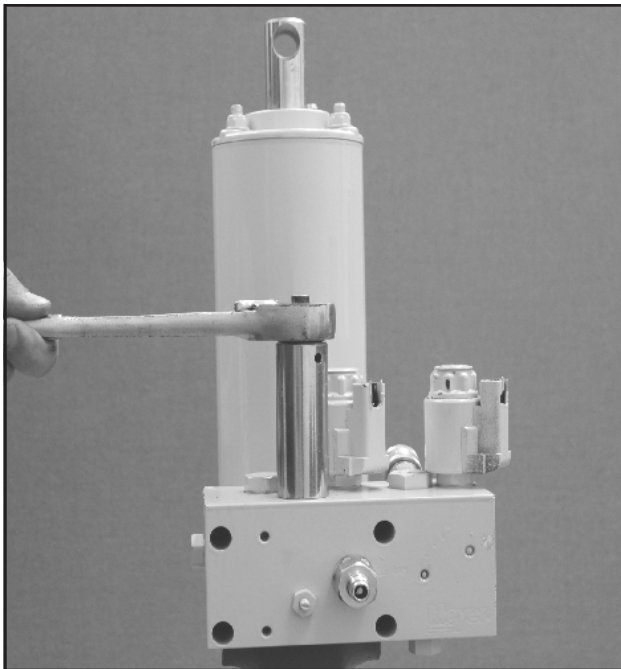

FIGURE 3-49

The "A" Cartridge is removed using a 7/8" hex deep socket.

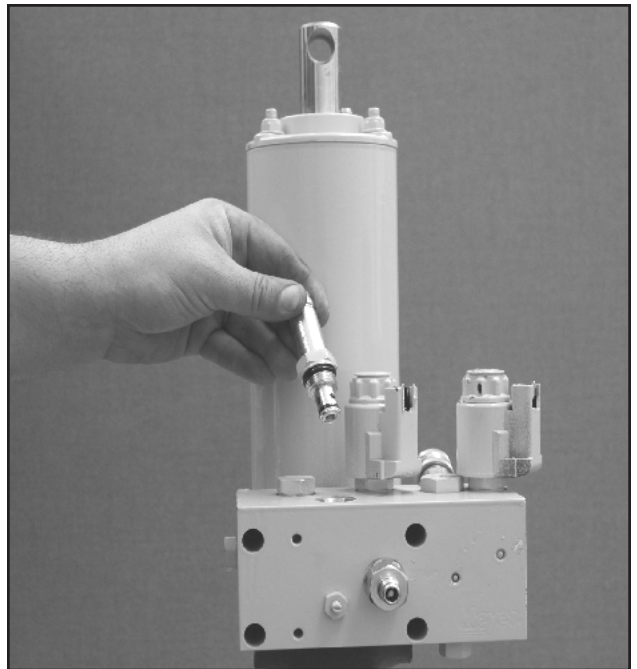

FIGURE 3-50

The "A" Cartridge is removed. Clean by soaking cartridge in cleaning solvent.

DISASSEMBLY - E-58H & E-78 ONLY

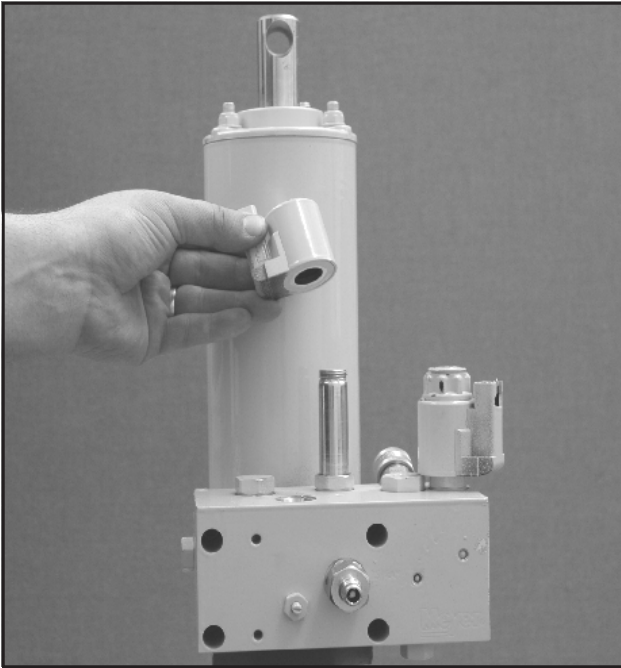

FIGURE 3-51
Remove the "B" Coil.

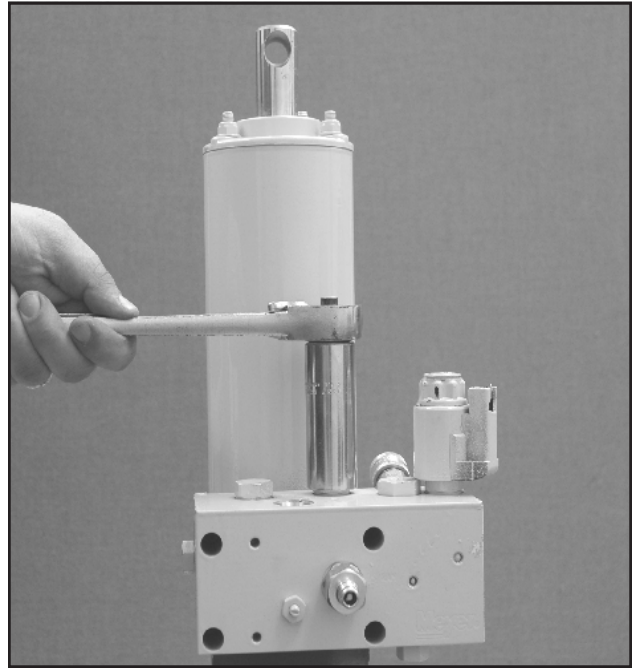

FIGURE 3-52
The "B" Cartridge is removed using a 7/8" hex deep socket.

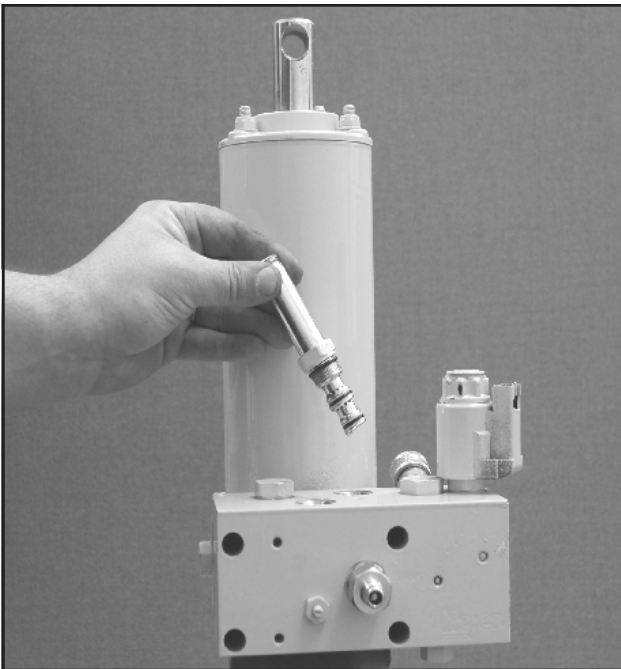

FIGURE 3-53
The "B" Cartridge is removed. Clean by soaking cartridge in cleaning solvent.

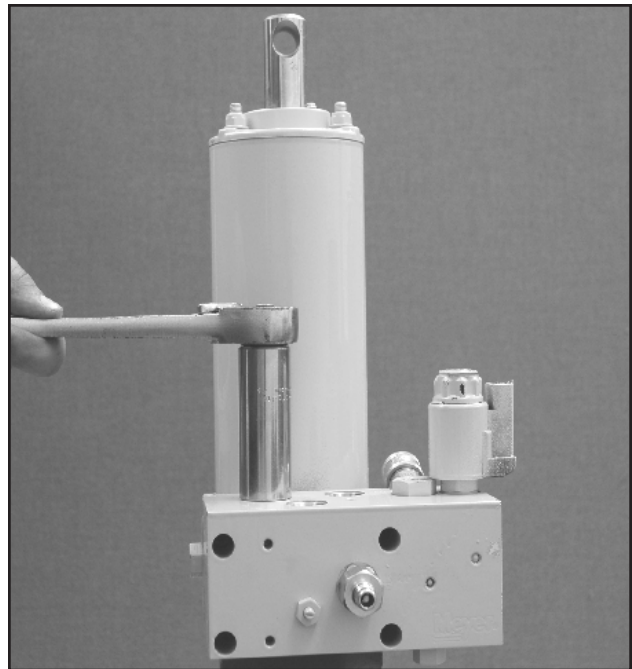

FIGURE 3-54
Use a 7/8" wrench or socket to remove the "B" Check Valve Nut.

DISASSEMBLY - E-58H & E-78 ONLY

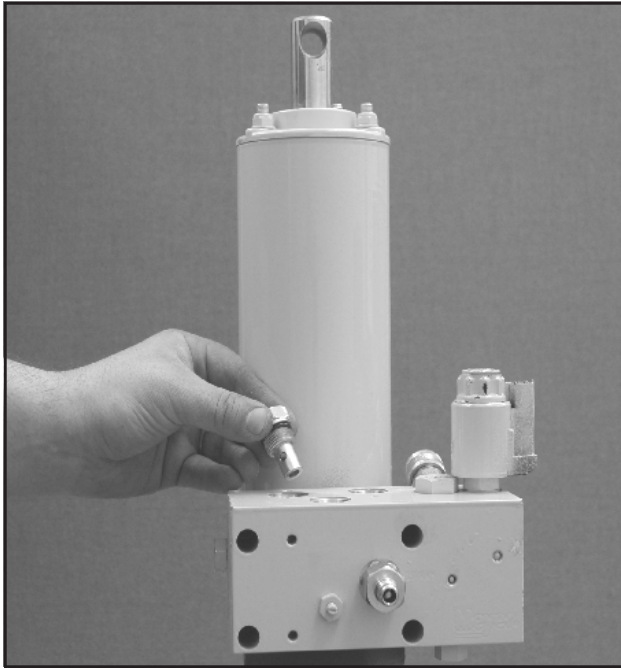

FIGURE 3-55
Remove "B" Check Valve Nut.

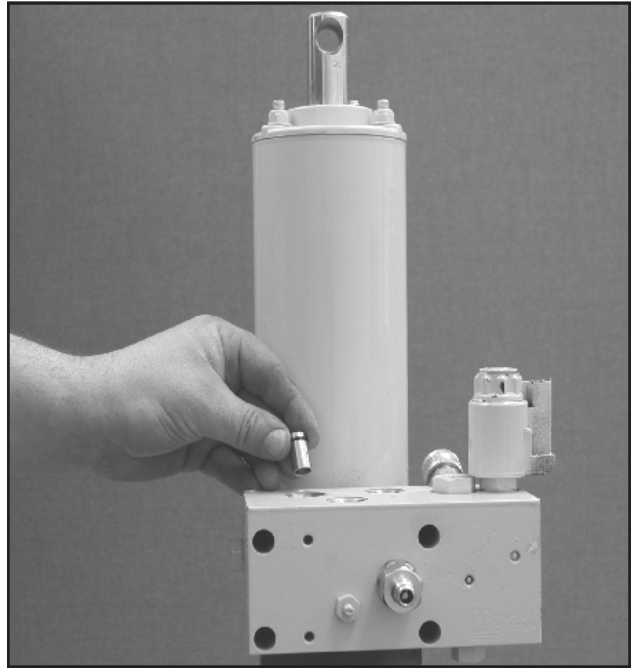

FIGURE 3-56
Retrieve the "B" Check Valve Body.

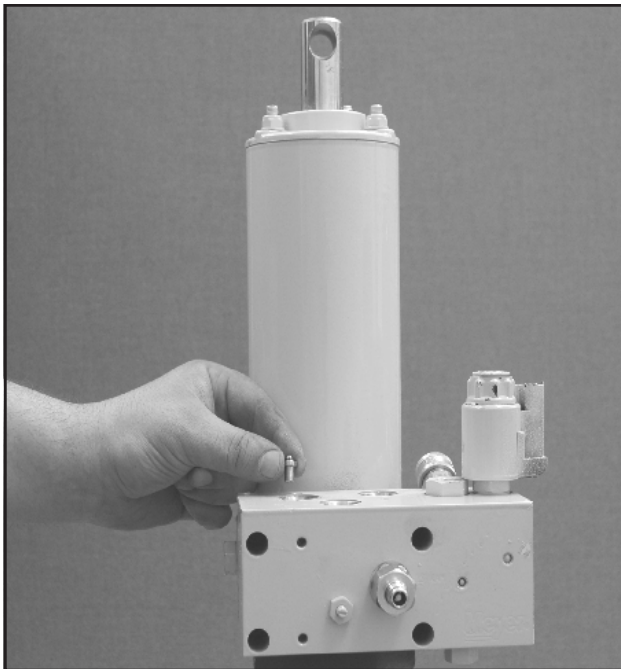

FIGURE 3-57
Use a magnet to retrieve the "B" Check Valve Poppet. The "B" Check valve poppet has been replaced by a ball. (See Service Bulletin 214) The "B" Check valve replacement kit is part number 15959.

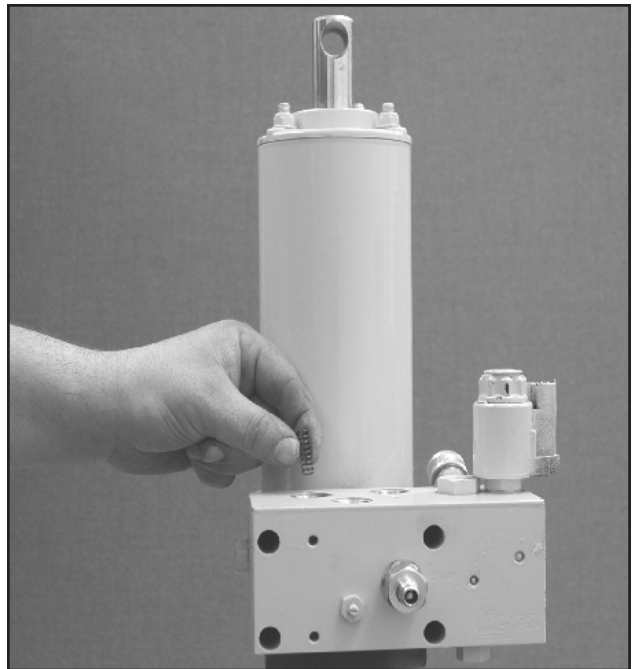

FIGURE 3-58
Retrieve the "B" Check Valve Spring.

DISASSEMBLY - E-58H & E-78 ONLY

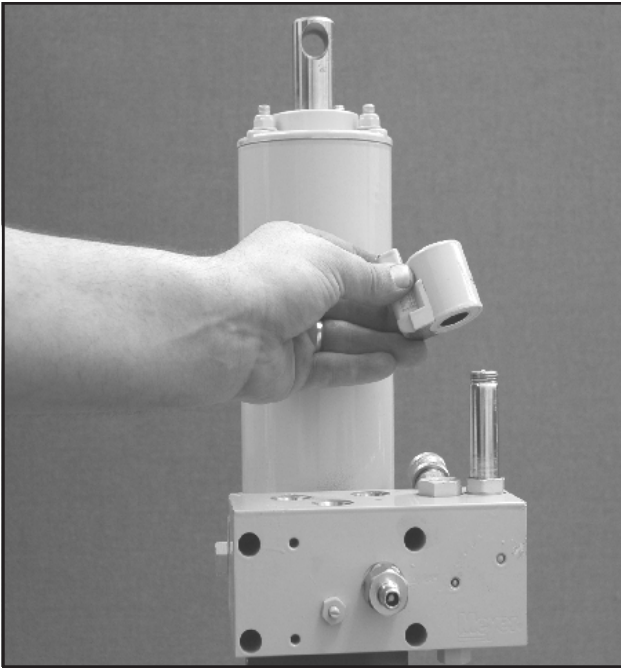

FIGURE 3-59
Remove the "C" Coil.

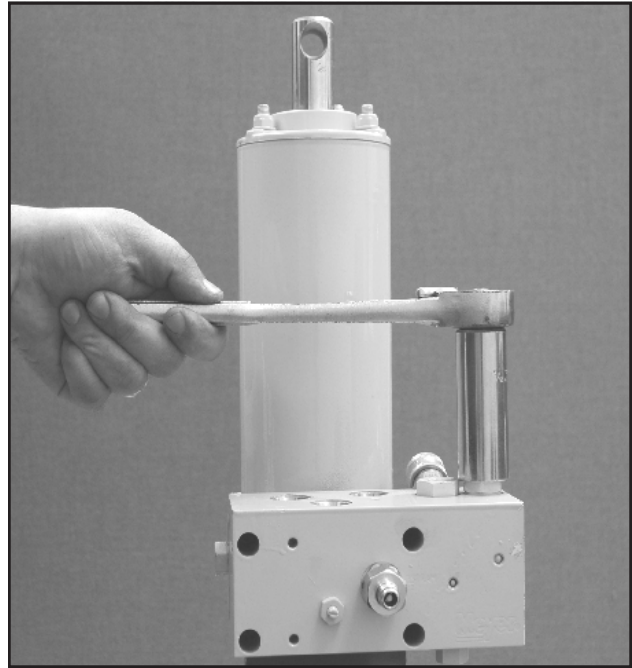

FIGURE 3-60
The "C" Cartridge is removed using a 7/8" hex deep socket.

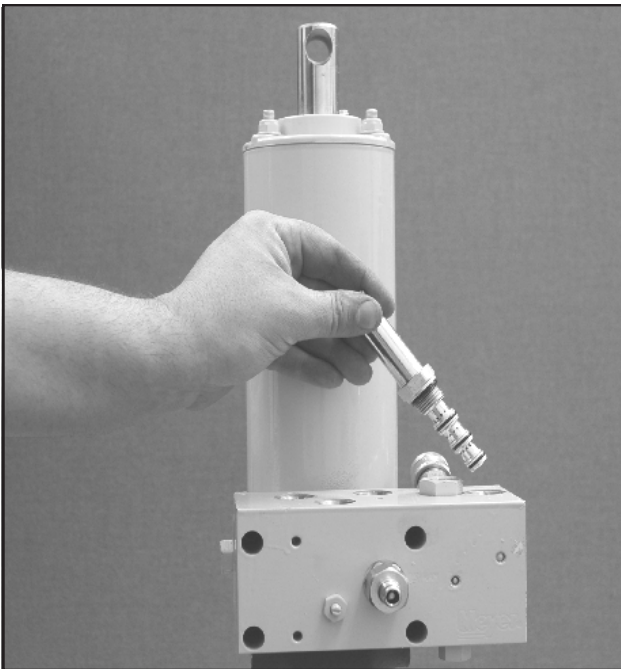

FIGURE 3-61
The "C" Cartridge is removed. Clean by soaking cartridge in cleaning solvent.

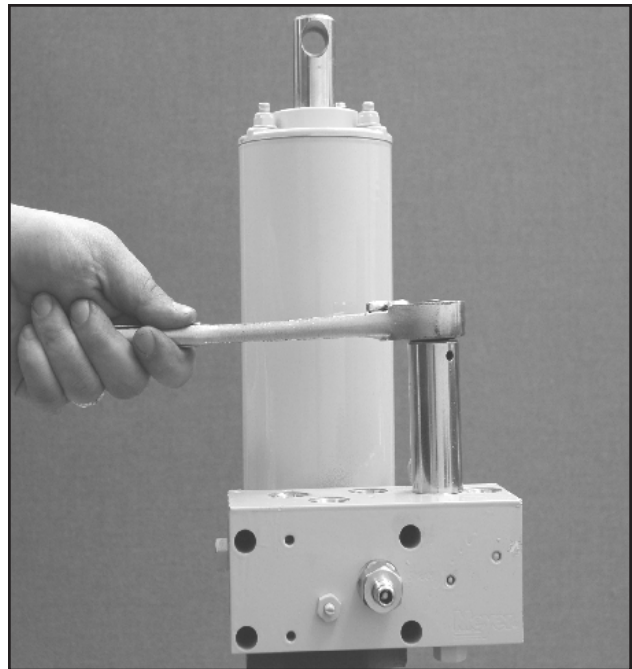

FIGURE 3-62
Use a 15/16" hex deep socket to remove the P.O. Check valve assembly used for angling.

DISASSEMBLY - E-58H & E-78 ONLY

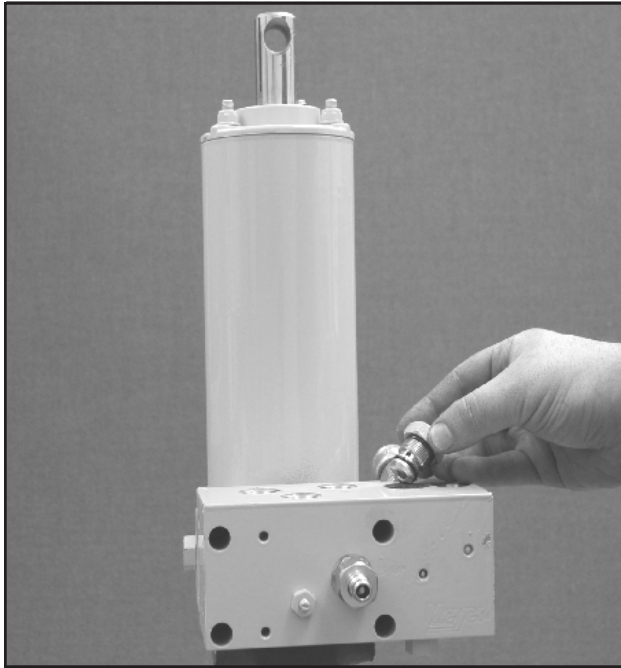

FIGURE 3-63

Remove the P.O. Check valve assembly. Clean by soaking Check valve in cleaning solvent.

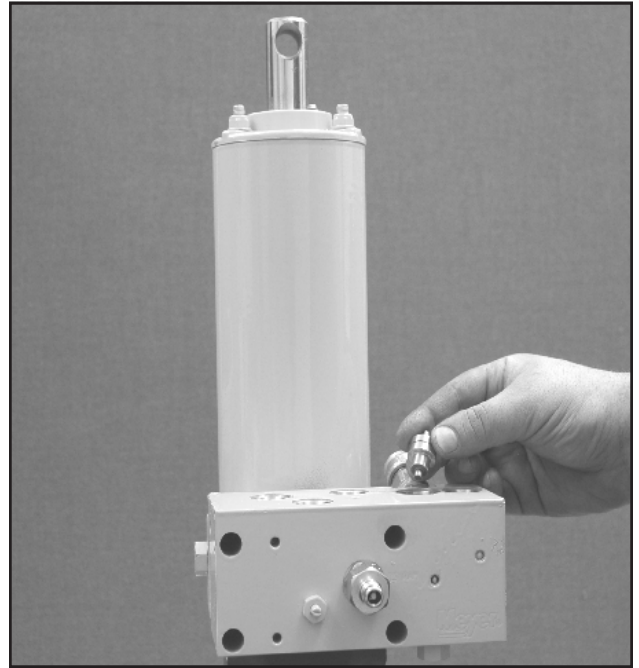

FIGURE 3-64

Remove the P.O. Pilot Piston & Spring underneath Piston.

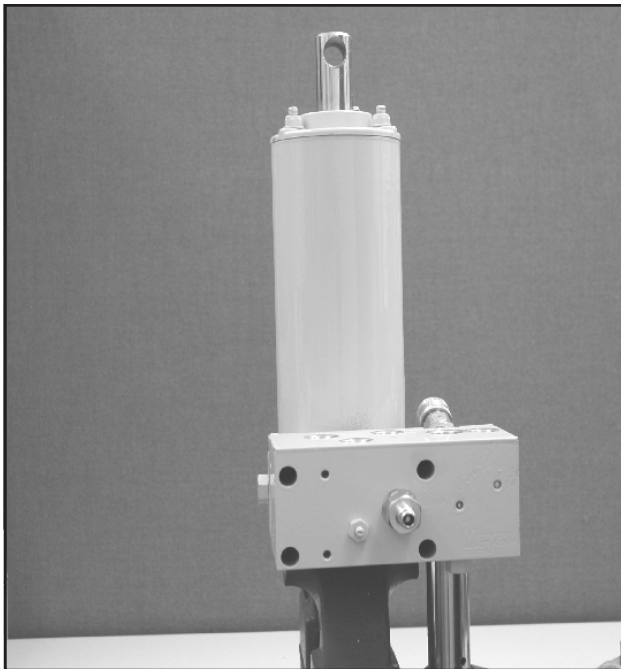

FIGURE 3-65

Use a 15/16" hex deep socket to remove the P.O. Check valve assembly used for angling.

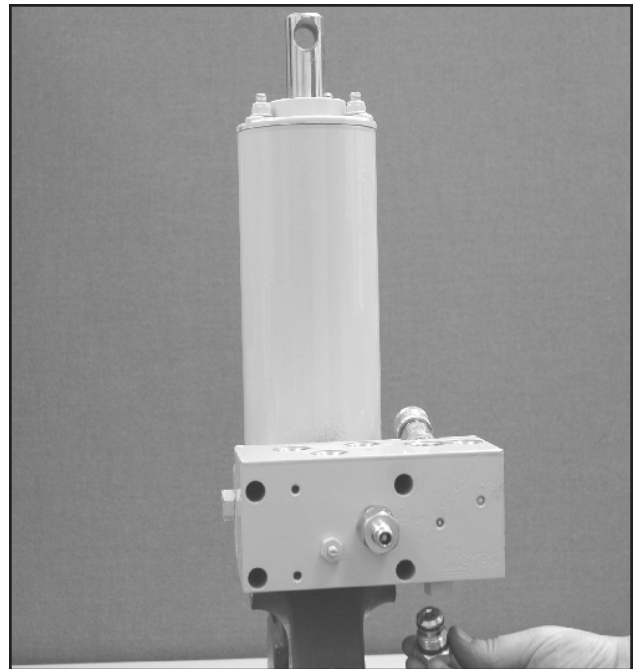

FIGURE 3-66

Remove the P.O. Check valve assembly. Clean by soaking Check valve in cleaning solvent.

DISASSEMBLY - E-58H & E-78 ONLY

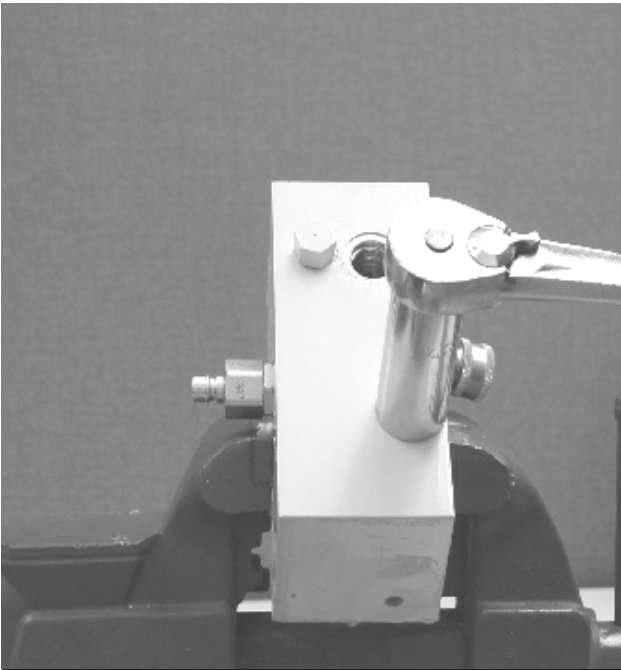

FIGURE 3-67

Use a 7/8" wrench or socket to remove filter plug.

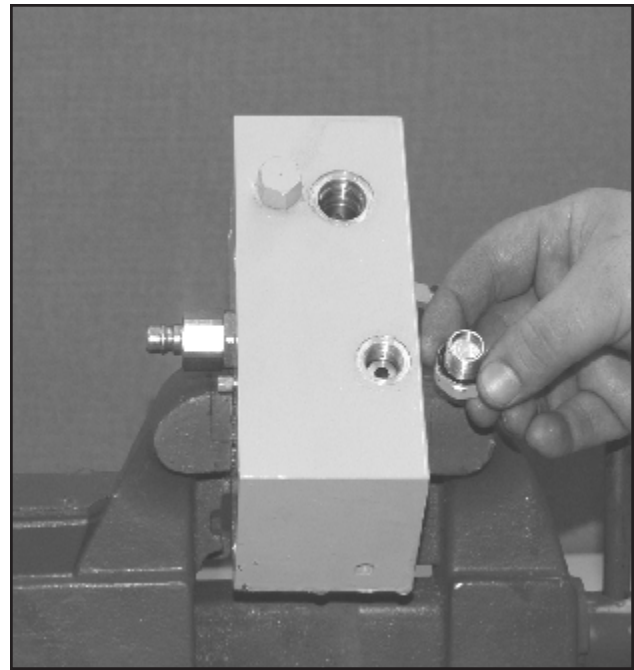

FIGURE 3-68

Remove Filter Plug.

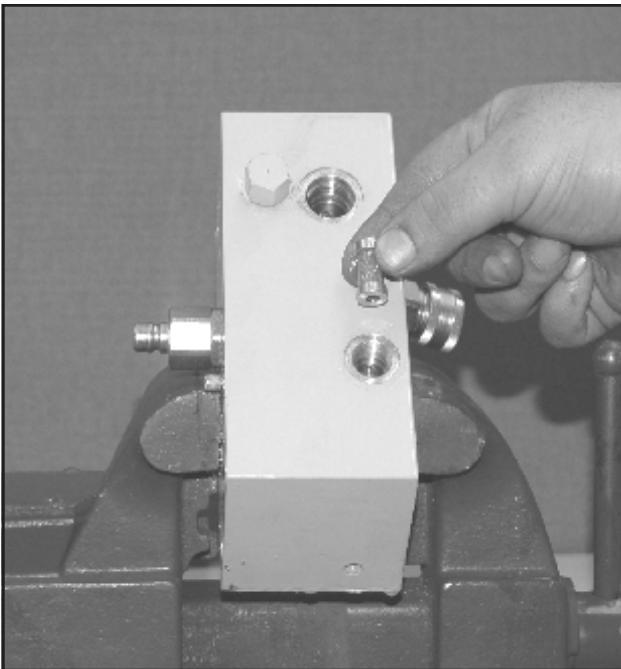

FIGURE 3-69

Remove the Filter. Clean by soaking Filter in cleaning solvent.

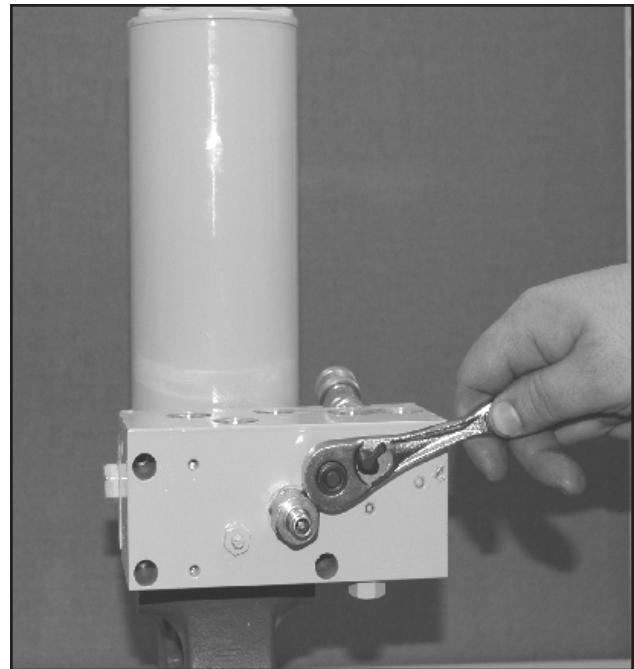

FIGURE 3-70

Use a 1/4" hex key or Allen Socket to remove the four valve block mounting bolts.

DISASSEMBLY - ALL MODELS

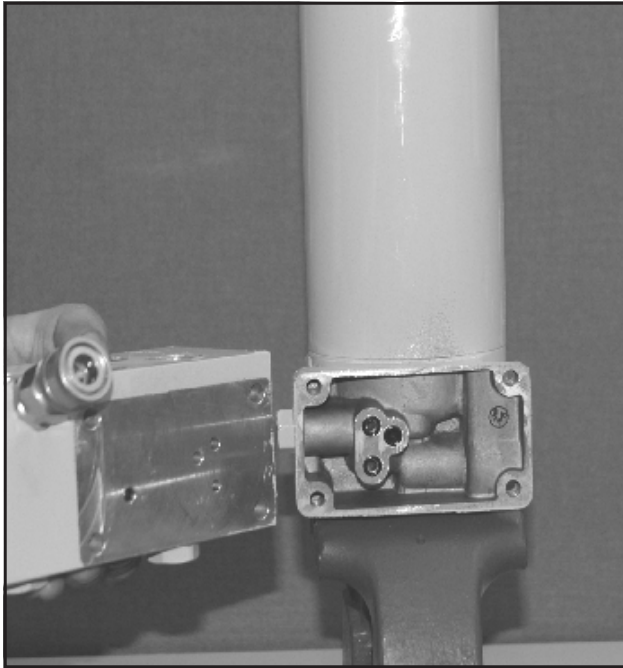

FIGURE 3-71

Use a 1/4" hex key or Allen Socket to remove pilot valve plug.

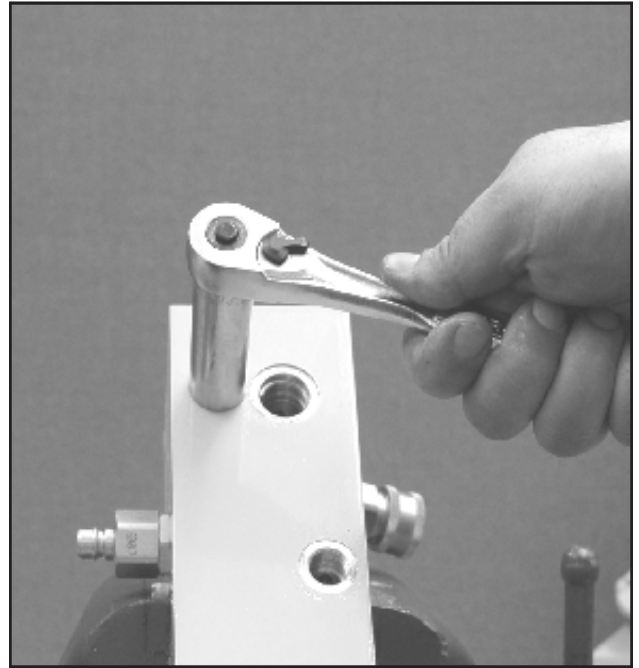

FIGURE 3-72

Use a 11/16" Wrench or Socket to remove Crossover Relief Valve.

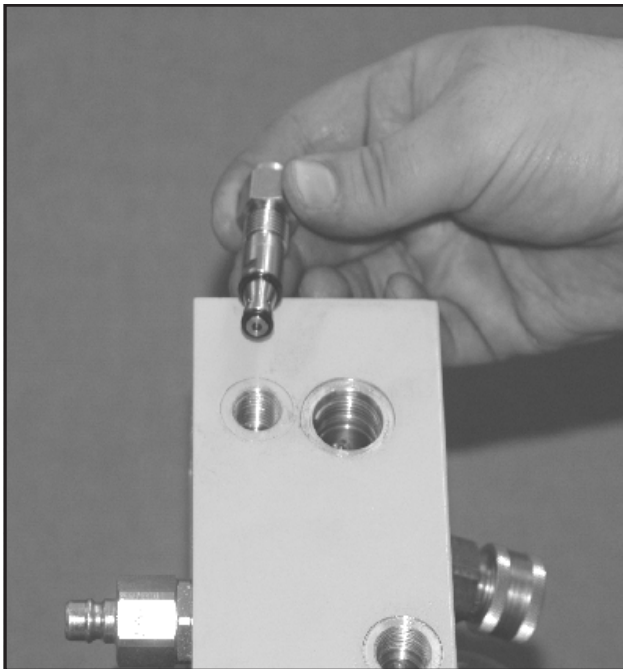

FIGURE 3-73

Remove Crossover Relief Valve.

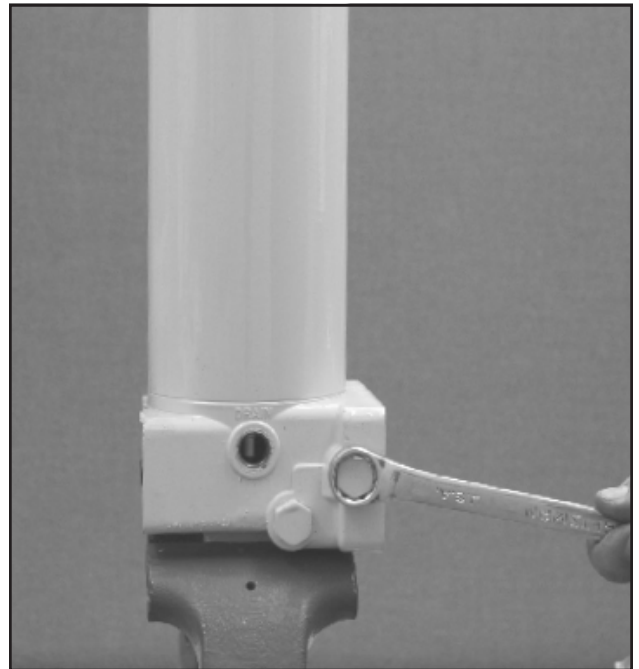

FIGURE 3-74

There is one filter on the base assembly. Remove filters with an 11/16" wrench.

DISASSEMBLY - ALL MODELS

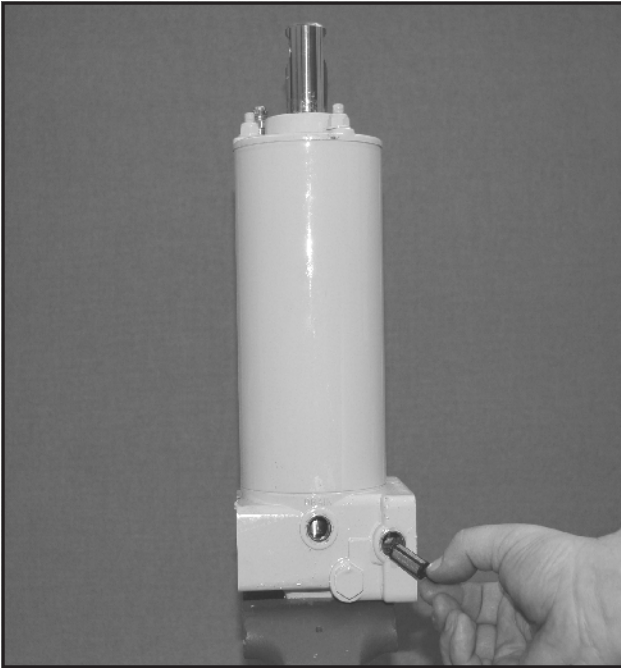

FIGURE 3-75

Filters removed; soak in kerosene before reassembling.

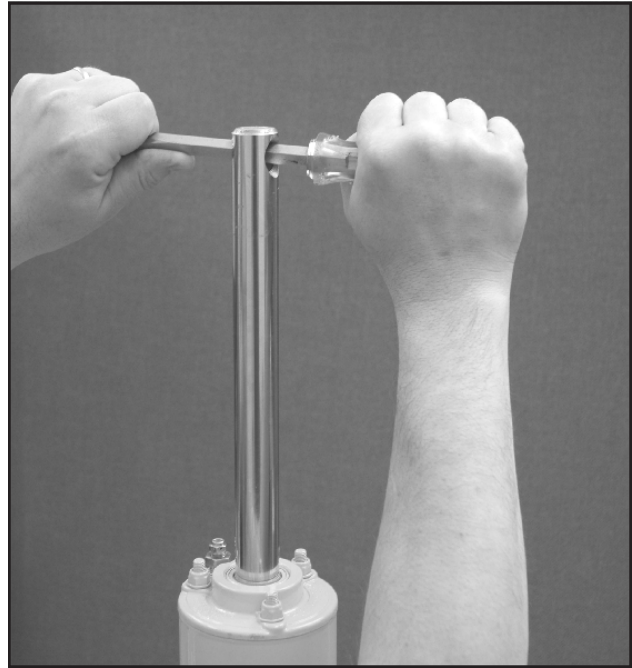

FIGURE 3-76

Before removing ram and piston assembly, extend rod fully. This drains out remaining oil in cylinder.

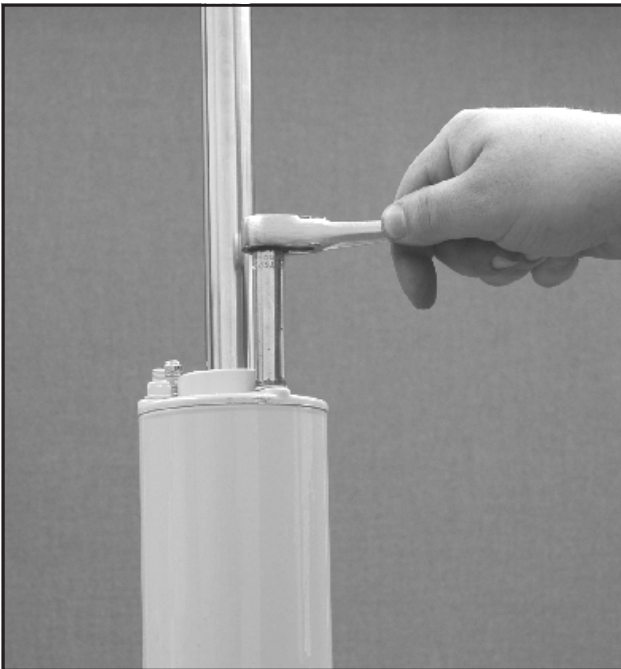

FIGURE 3-77

When disassembling the reservoir-cylinder assembly use a 1/2" hex socket to remove the lock nuts. The studs usually unscrew from the base with the nuts.



FIGURE 3-78

Cover is removed from reservoir using a large screw driver and hammer or mallet as shown, tapping lightly around the top cap.

DISASSEMBLY - ALL MODELS

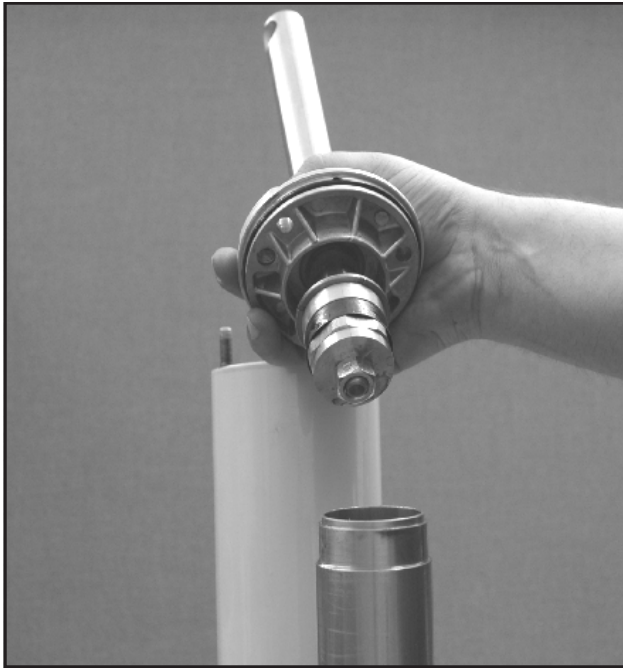

FIGURE 3-79

Remove ram and cylinder assembly from reservoir then pull ram out of cylinder. Worn packing cup on piston should be replaced if cloth backing is visible.

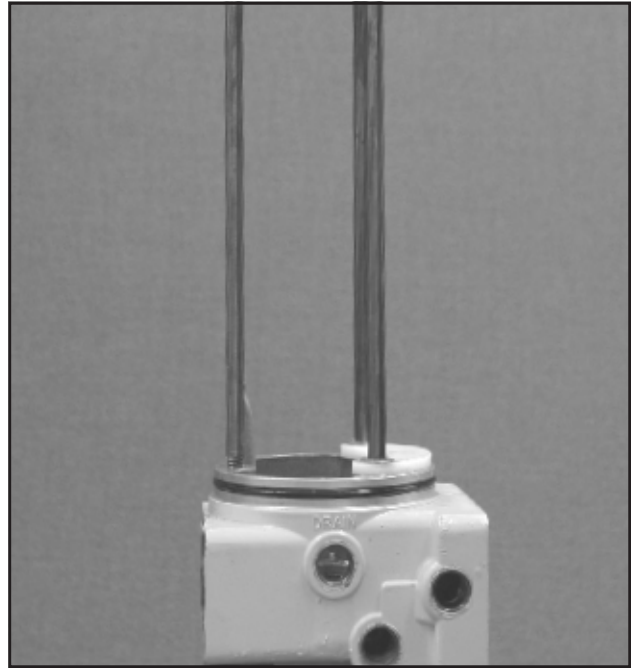

FIGURE 3-80

Remove nuts, baffle and retainer rings from studs and screw the studs into the base. Clean reassemble Sump Base in reverse order.

REASSEMBLY - ALL MODELS



FIGURE 3-81

Clean all paint from ram then slide the cylinder over the ram piston assembly using a rubber or leather mallet.

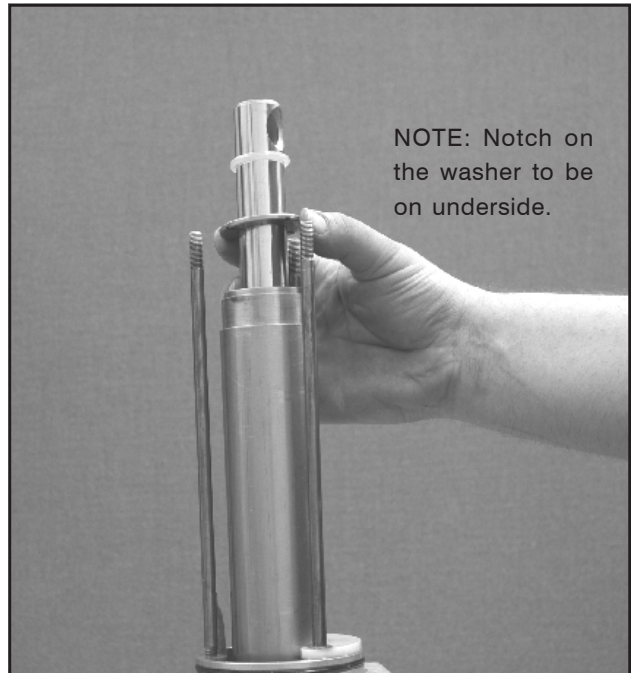

FIGURE 3-82

Install cylinder assembly carefully being certain it seats squarely on "O" ring in base. Assemble O-Ring and Washer as shown.

REASSEMBLY - ALL MODELS



FIGURE 3-83

Reinstall reservoir using mallet to seat reservoir squarely.

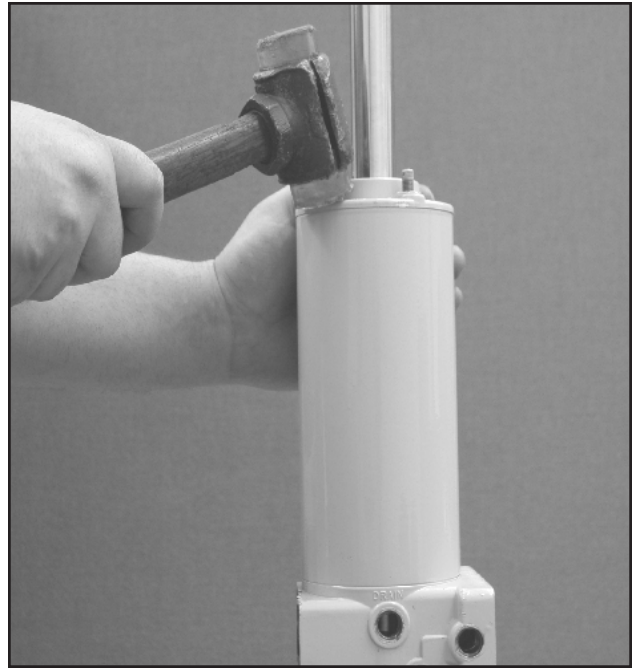

FIGURE 3-84

Install cover assembly using mallet to seat cover, making certain filter plug is properly located next to the electric motor.

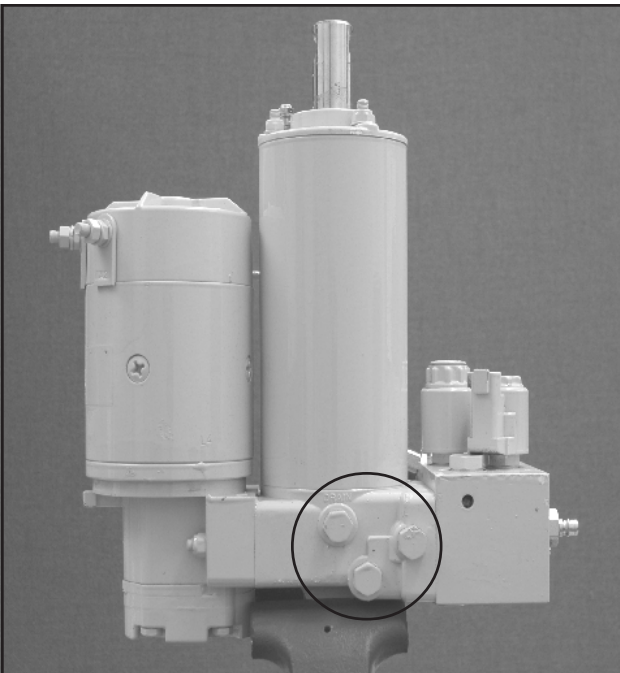

FIGURE 3-85

Drain plug and filters to be torqued to 75-85 in. lbs. with an 11/16" hex socket. Remove nuts from pump studs and screw into base.

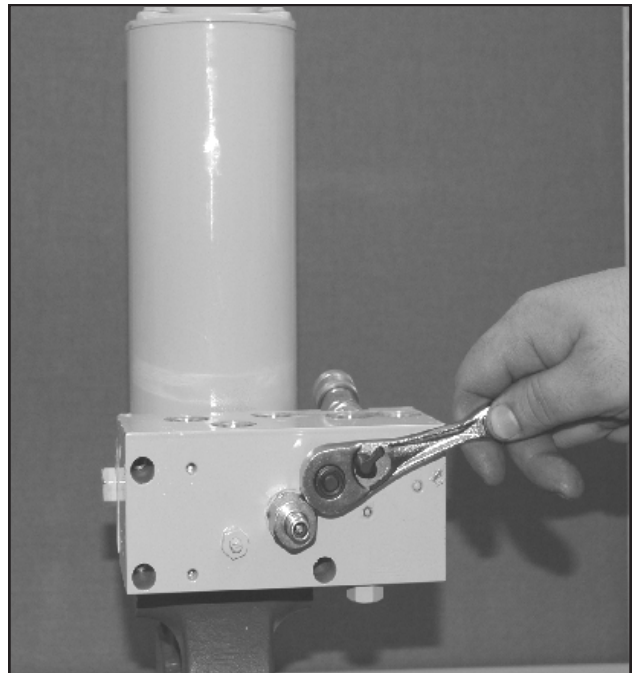

FIGURE 3-86

Torque the bolts to 100-125 in. lbs. using a 1/4" hex key or Allen Socket.

REASSEMBLY - ALL MODELS

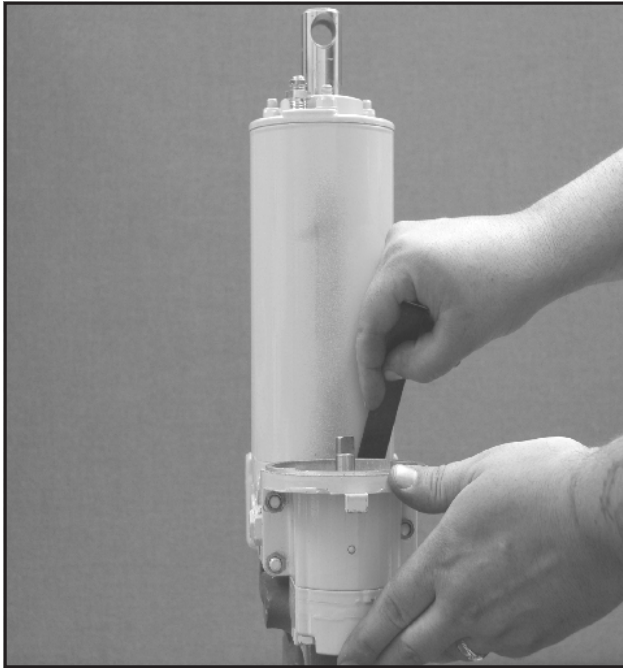

FIGURE 3-87

Use a flat tool to hold the pump check valve in place and assemble pump. Torque the pump to 100-125 in. lbs. using a 1/2" hex socket on the locknuts.

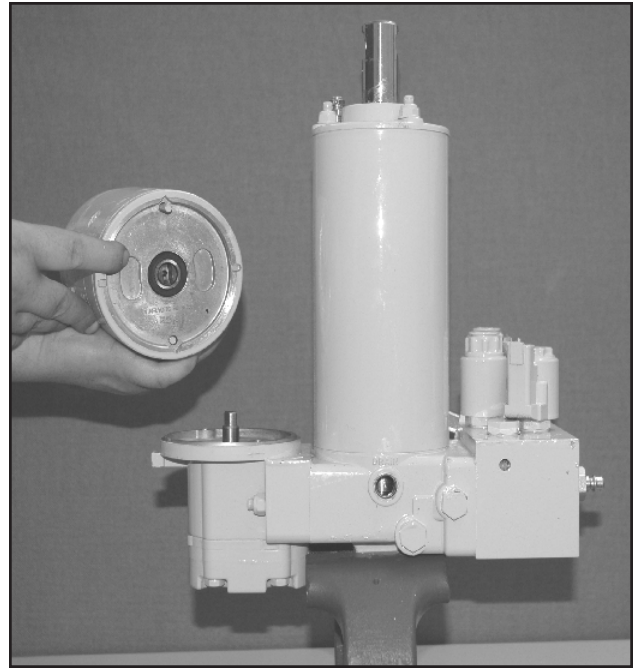

FIGURE 3-88

To reinstall motor, align pump shaft quill and motor shaft with appropriate bolt holes.

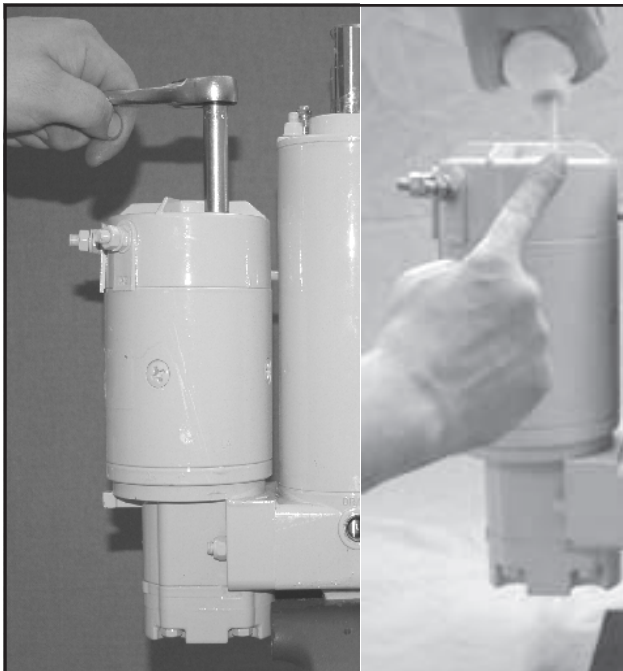
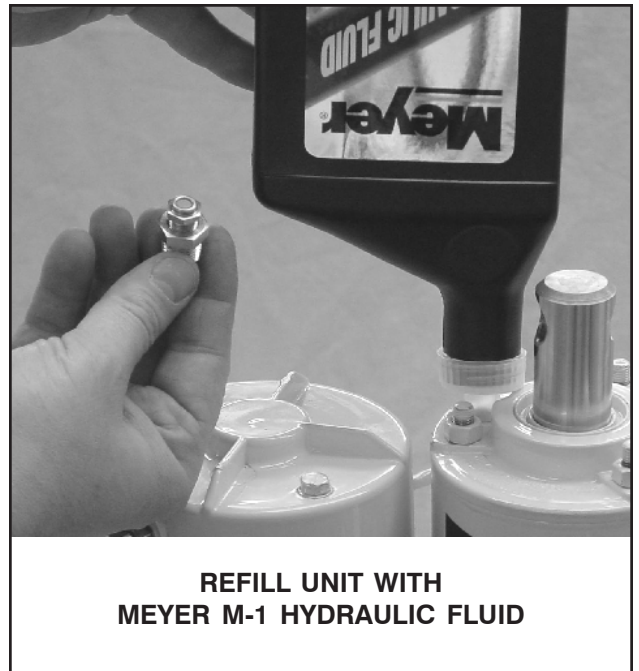

FIGURE 3-89

Torque cap screws to 45 - 55 in. lbs., then apply Permatex Form-A-Gasket No. 2 or equivalent sealant around each cap screw head.



**REFILL UNIT WITH
MEYER M-1 HYDRAULIC FLUID**

FIGURE 3-90

Follow instructions under
"Replacement of Hydraulic Fluid"
See POST SEASON MAINTENANCE on page 3

CROSSOVER RELIEF VALVE DISASSEMBLY - ALL MODELS



FIGURE 3-91
One piece Crossover Relief Valve.

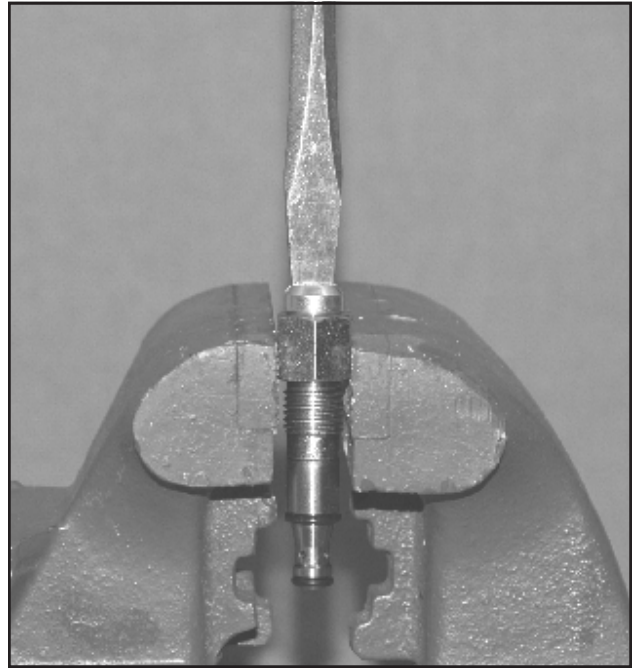

FIGURE 3-92
Use a screwdriver to loosen Plug to access the Spring.

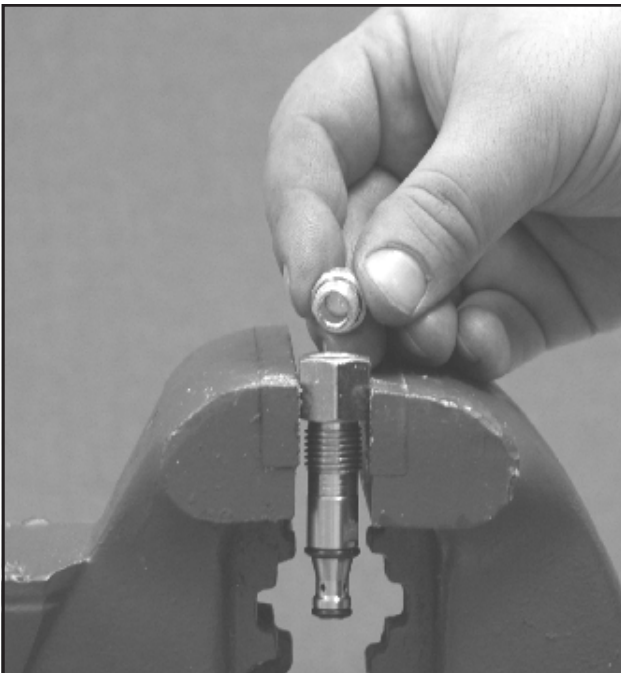

FIGURE 3-93
Remove Plug.

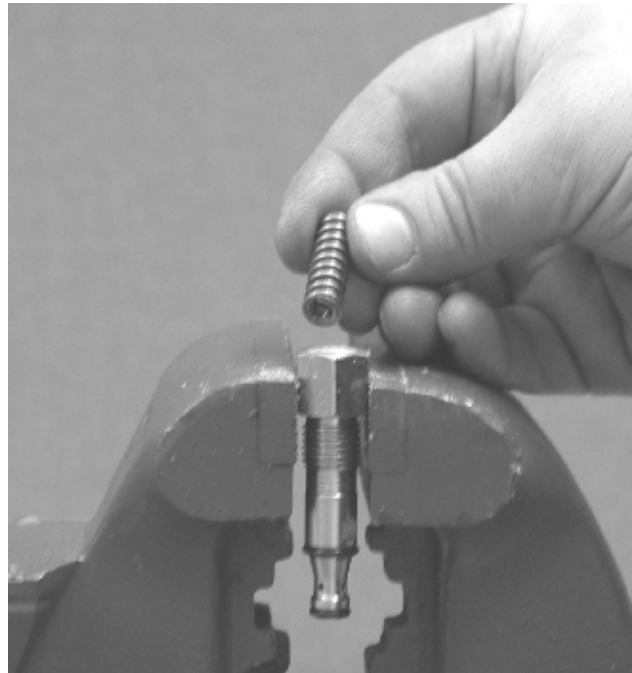

FIGURE 3-94
Remove Spring.

CROSSOVER RELIEF VALVE DISASSEMBLY - ALL MODELS

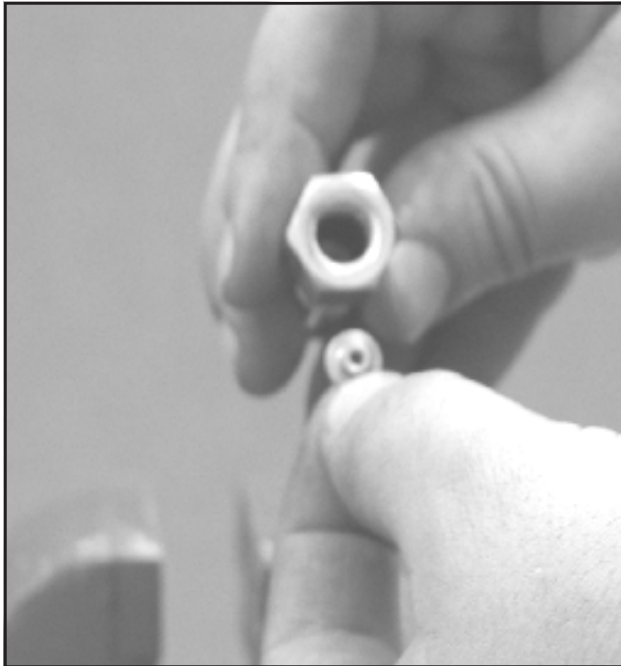

FIGURE 3-95
Remove Washer.

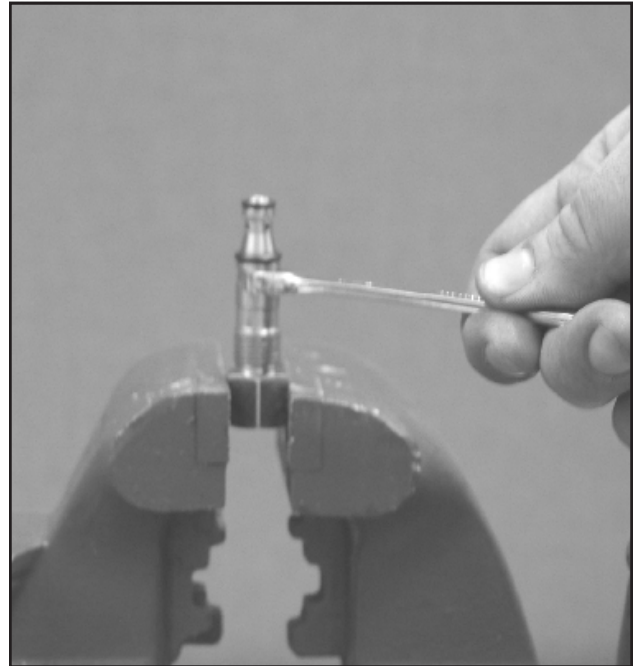

FIGURE 3-96
Use a "thin" 7/16" wrench to loosen Body.

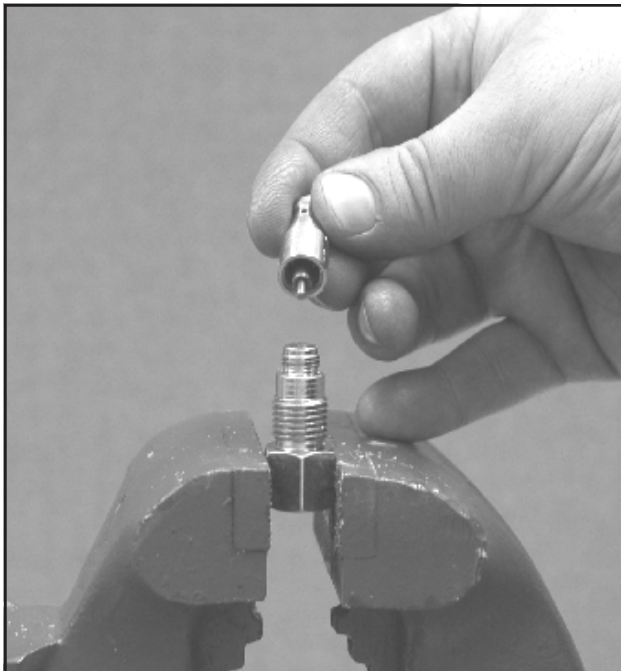

FIGURE 3-97
Separate Body.

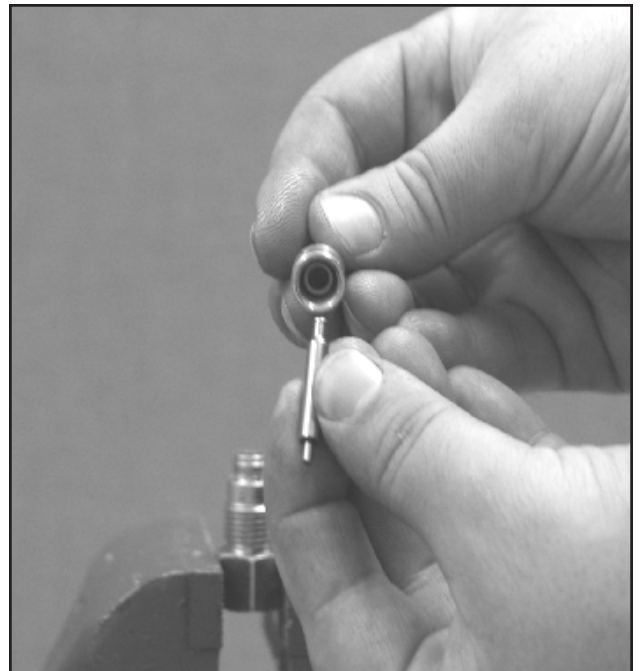

FIGURE 3-98
Pull Pin out of lower half of Body. Remove O-ring and Glyd. Ring.

CROSSOVER RELIEF VALVE REASSEMBLY - ALL MODELS

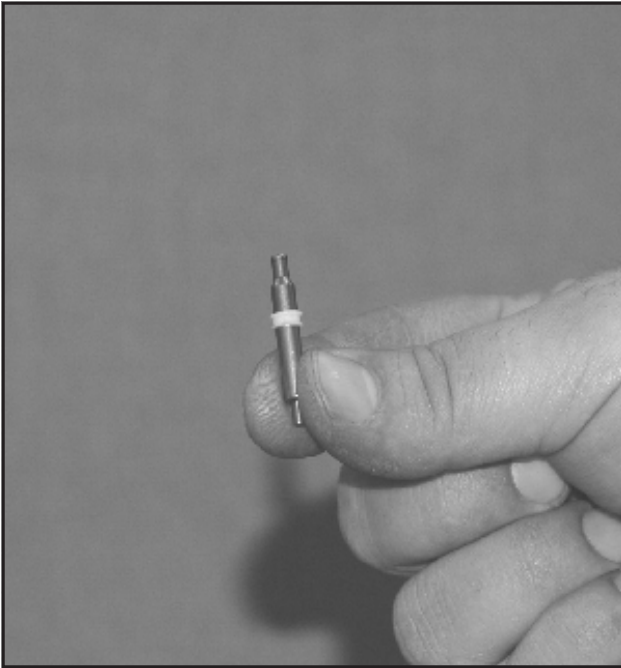

FIGURE 3-99
Carefully slide Glyd. Ring over Pin.

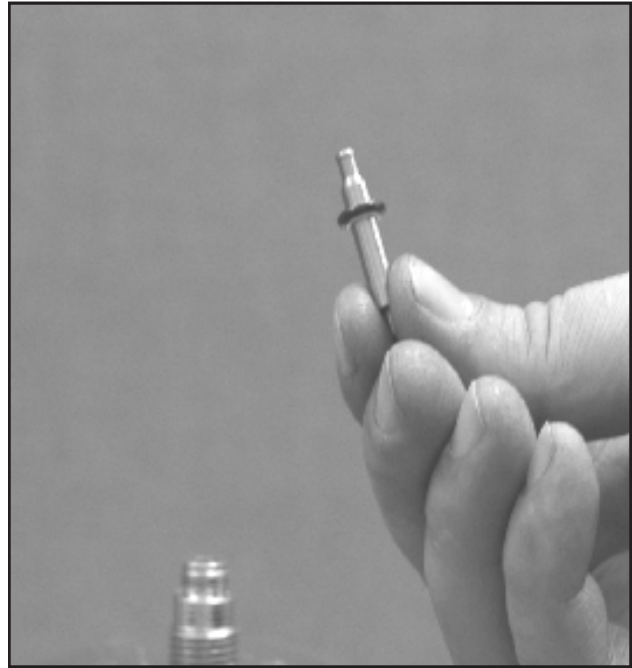

FIGURE 3-100
Carefully slide O-ring over Glyd. Ring.

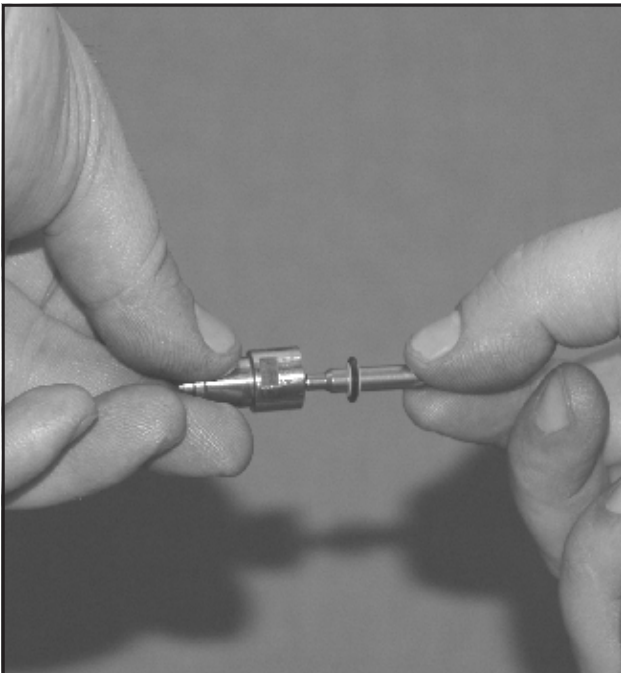

FIGURE 3-101
Slide Pin with the small end first into the lower half of Body.

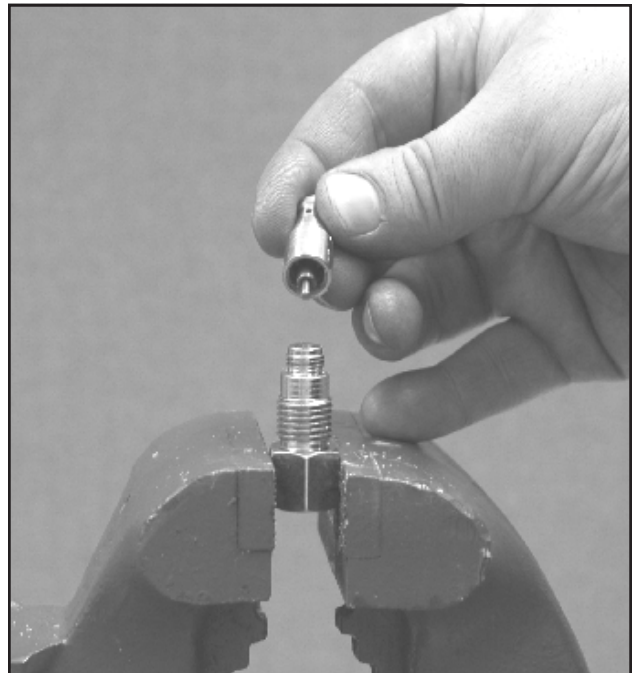

FIGURE 3-102
Reinstall lower half of Body to the upper half. The upper half of the body will press the O-ring with Glyd. ring into place.

CROSSOVER RELIEF VALVE REASSEMBLY - ALL MODELS

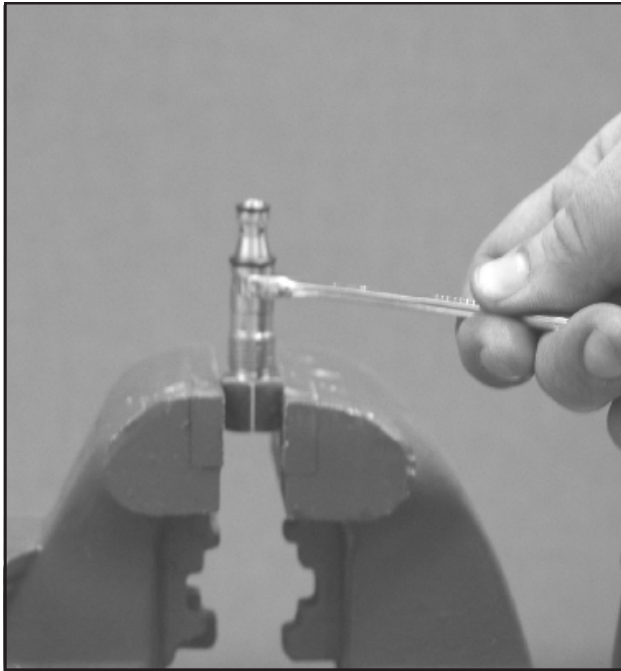

FIGURE 3-103
Use a "thin" 7/16" wrench to loosen Body.

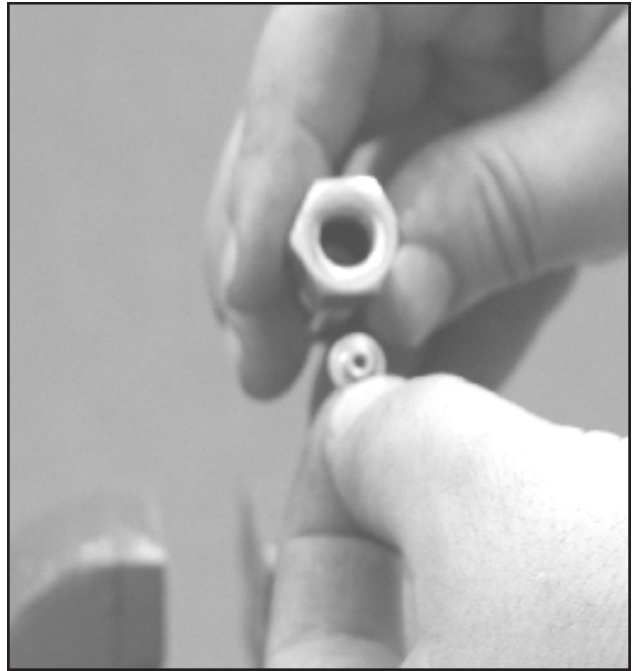

FIGURE 3-104
Remove Washer with flat side facing down.

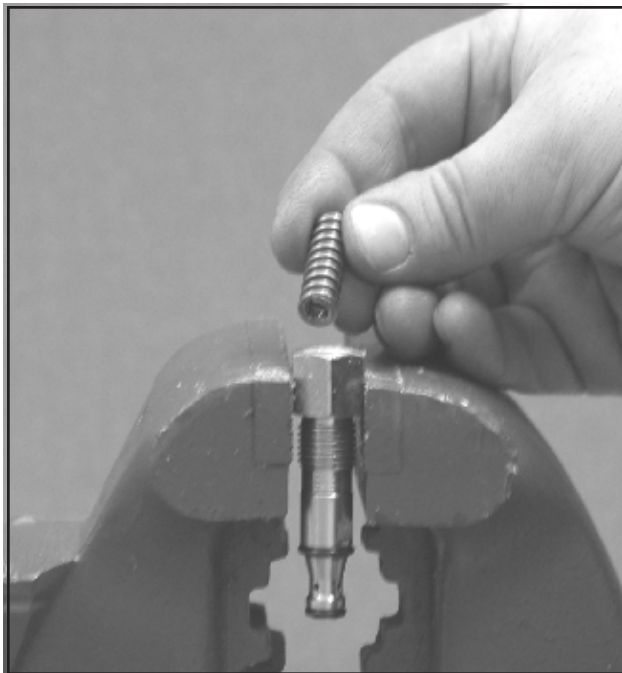

FIGURE 3-105
Install Spring.

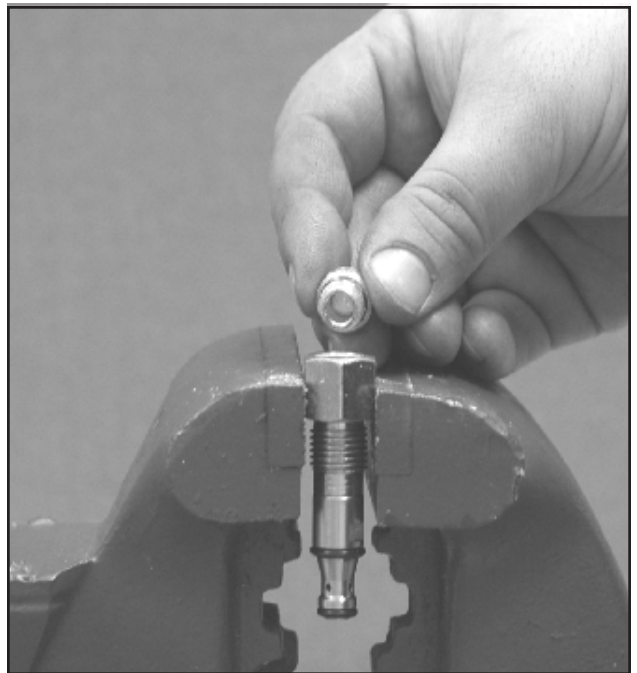

FIGURE 3-106
Install Plug.

CROSSOVER RELIEF VALVE REASSEMBLY - ALL MODELS

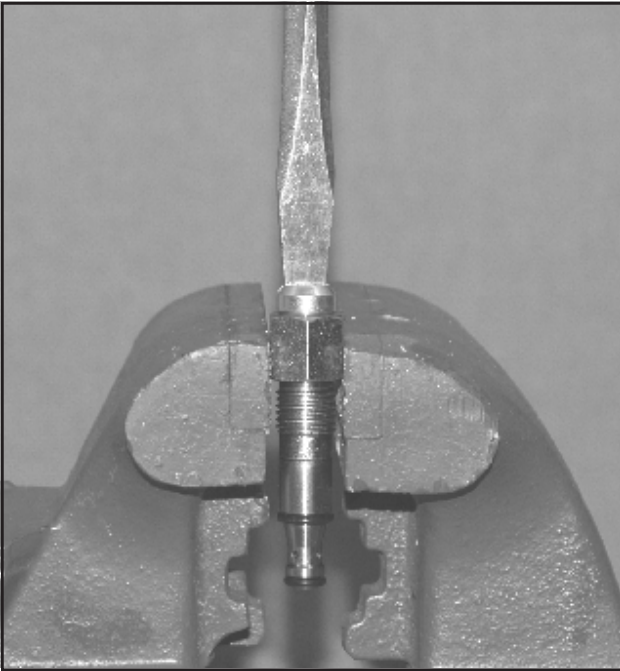

FIGURE 3-107
Use a screwdriver to tighten Plug.



FIGURE 3-108
Insert small O-ring into the Crossover cavity of the P.A. Block. Make sure small O-ring fits flat in the bottom of the cavity.

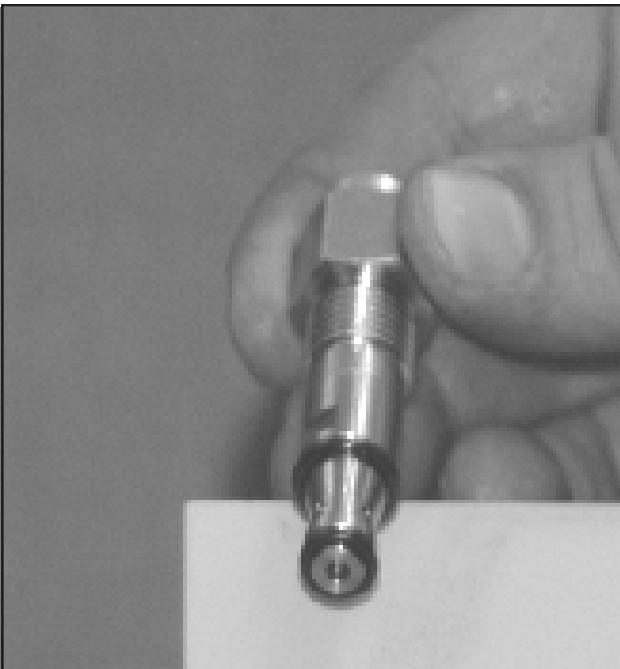

FIGURE 3-109
Insert larger O-ring into the Crossover cavity until it sitting flat on its landing.

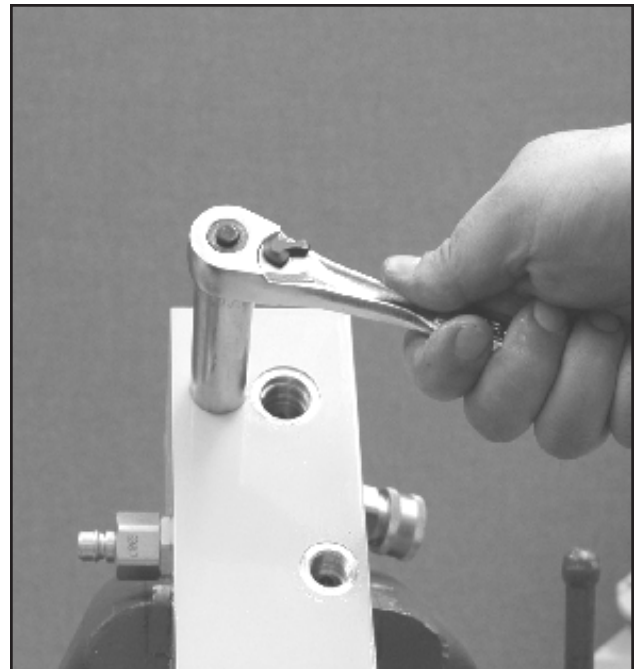

FIGURE 3-110
Use a 11/16 Wrench or Socket to tighten Crossover Relief Valve.

REASSEMBLY - E-78

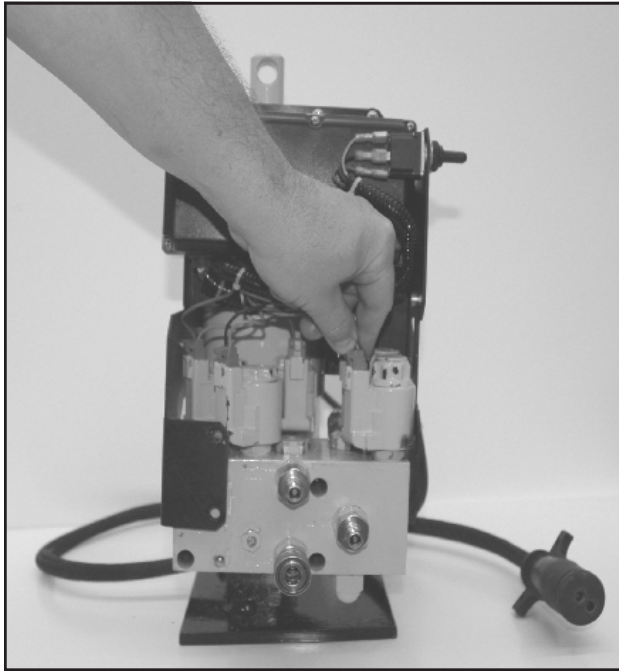

FIGURE 3-111

Gently install electronic framing over hydraulic unit until coil wire plugs are accessible to the coils. Plug coil wire plugs into the proper coils. See Figure 3-112

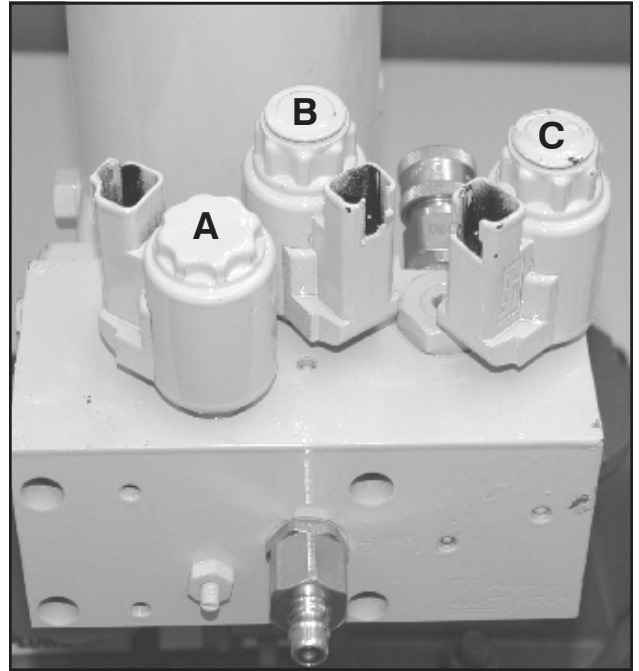

FIGURE 3-112

"A" Coil is Black and Tan wires, "B" Coil is Red and Tan wires and "C" Coil is Green and Tan wires.

REASSEMBLY - E-88

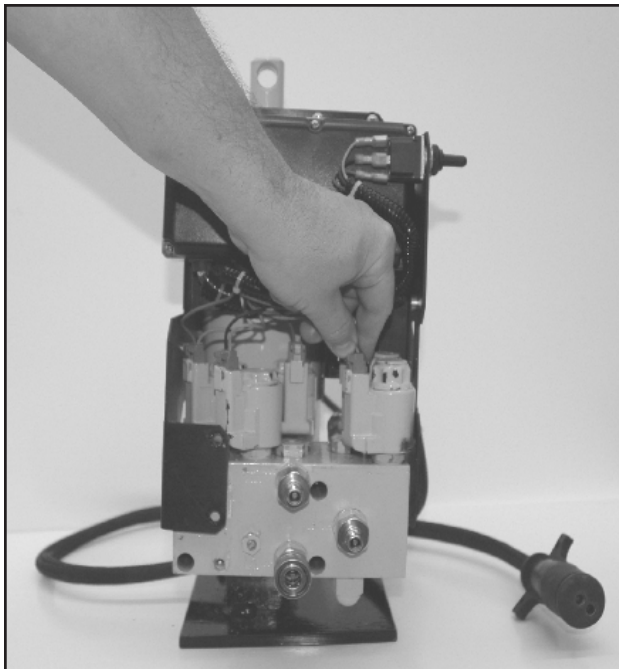

FIGURE 3-113

Gently install electronic framing over hydraulic unit until coil wire plugs are accessible to the coils. Plug coil wire plugs into the proper coils. See Figure 3-114

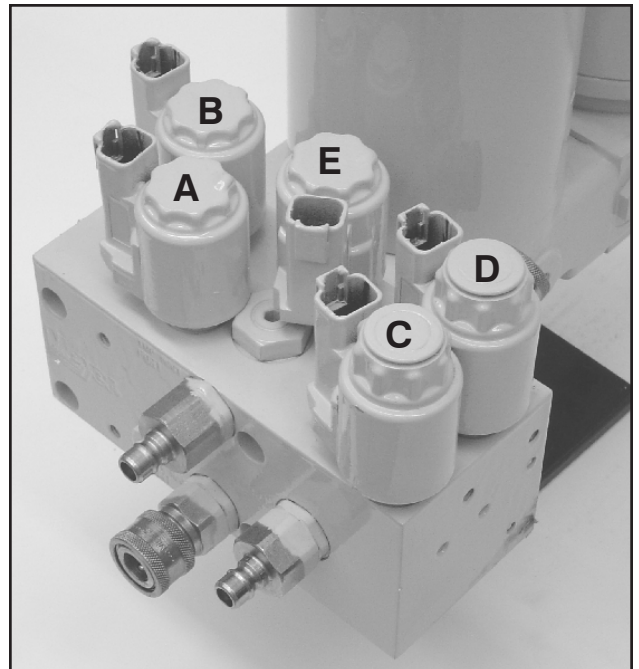

FIGURE 3-114

"A" Coil is Black and Tan wires, "B" Coil is Red and Tan wires, "C" Coil is Green and Tan wires, "D" Coil is Yellow and Tan wires and "E" Coil is Purple and Tan wires.

REASSEMBLY - E-78 & E-88

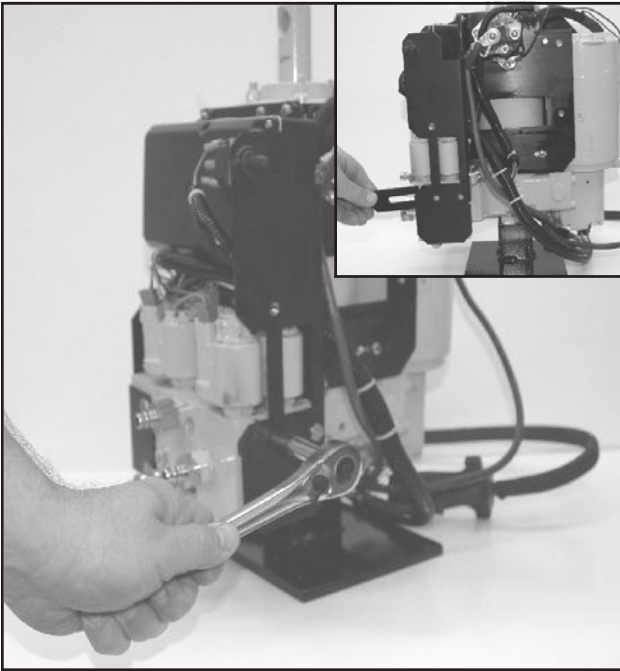

FIGURE 3-115

Install two 1/4" bolts using a 7/16" Socket or wrench. Be sure to reinstall shim.

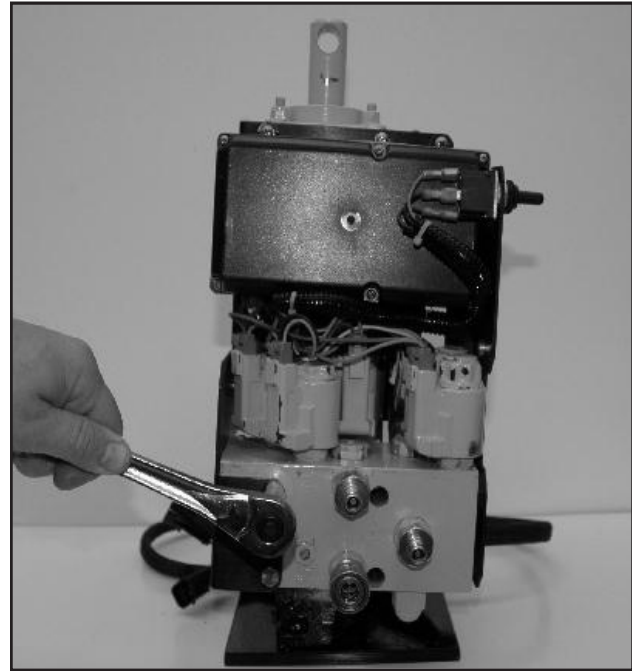
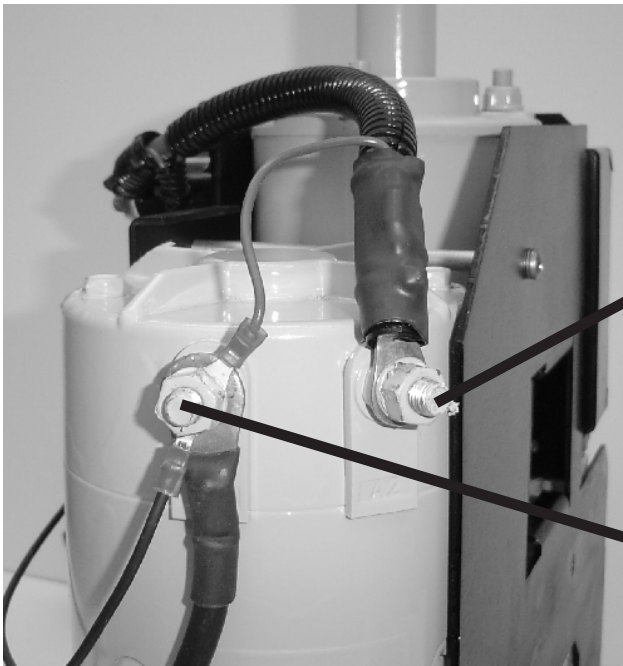

FIGURE 3-116

Install two 1/4" bolts using a 7/16" Socket or wrench.



A2 has a large red wire (Positive)

D1 has a large black wire along with a small black wire and small red wire. (Negative)

FIGURE 3-117

Using a 1/2" Socket or Wrench attach the two nuts holding the positive and negative wires to the motor.

REASSEMBLY - E-78 & E-88



FIGURE 3-118

Install three phillips head screws from the rear cover.



FIGURE 3-119

Install two phillips head screws from the front cover.

BRUSH REPLACEMENT OF ISKRA MOTOR - All Models

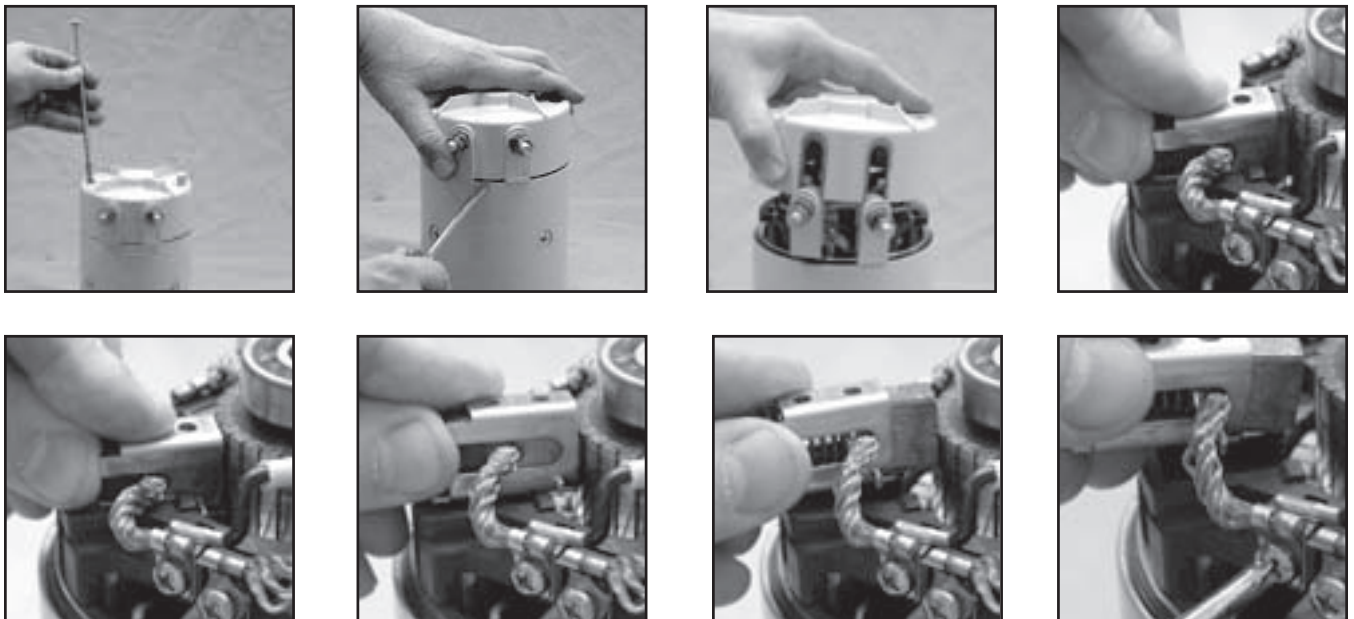

FIGURE 3-120

Remove motor from hydraulic unit. Remove top cap from motor housing. To replace brushes (part # 15854) start by pushing each brush assembly towards the commutator. Remove old assembly from the insulated mounting plate, removing retaining screws. Replace with a new brush assembly by reversing the above procedure. It is recommended that each brush be changed in turn to avoid confusion, make sure that each brush assembly is replaced with the correct part that has the brush cable on the the same side. Service Kits consist of 2 matching pairs of brush assemblies.

ELECTRONIC TROUBLESHOOTING E-78 & E-88

1. Basic E-78 and E88 System Description

The system is made up of three main components consisting of the Remote Control Module (RCM), Plow Control Module (PCM) and Headlamp Control Module (HCM).

The RCM is located in the truck cab in the form of a handheld joystick controller. The RCM is the device the snow plow operator uses to perform plow functions. The RCM uses a LCD display to reference snow plow status.

RCM



The PCM is located on the hydraulic unit which is mounted to the lift frame on front of the vehicle. The PCM is wired to the motor solenoid, valve block solenoids and plow lights. When a movement command is sent from the RCM it is translated by the PCM into electrical outputs to activate the appropriate solenoids to get the proper snow plow movement to occur.

PCM



The HCM is located in the engine compartment and is wired into the vehicle's headlights via the adapter harness. Park and turn signal wires are hard wired to the vehicle park and turn circuit. When the plow is mounted on the truck and is powered on the HCM detects the presence of a PCM. If the truck's headlights are turned on the HCM will disable the truck headlights and send a command to the PCM to turn on the plow lights. The HCM will also send turn and park commands to the PCM when they are detected by the wiring.

HCM



All the commands or communications between the three modules is performed through the power (+) and ground (-) wiring for each module. Due to commands being transmitted over the power lines it is very important that all connections be attached directly to the vehicle battery tight and secure to maintain good communication.

2.0 General Installation Tips

These things can cause intermittent operation:

1. Loose connections between the modules and their associated power sources.
2. Operating the RCM while plugged into the vehicle's cigarette lighter or accessory port.
3. Low battery voltage, for good communication maintain at least 11 VDC.

A low voltage situation will cause the system to operate intermittently. It may be necessary to power cycle the modules. You can perform this by doing the following:

Step 1 RCM – Power off by depressing the green power button for 3 seconds then unplug the power cable from the Meyer accessory jack. Then plug cable back in and power on RCM.

Step 2 PCM – Unplug the plow cable from connector on plow frame, wait 10 seconds then plug back in.

Step 3 HCM – Locate fuse holder on red power wire (near vehicle battery) and open fuse holder by twisting, remove fuse, wait 10 seconds then put fuse back into fuse holder.

3.0 Xpress Plow General Operation Instructions

These instructions assume a system install has been completed.

Power Up Sequence:

1. PCM This device should be already powered on at the plow plug.
2. HCM This device should be already powered on, direct connect to battery.
3. RCM Press power button for 1 second.

ELECTRONIC TROUBLESHOOTING E-78 & E-88

Power Down Sequence:

1. RCM Press power button for three seconds.
2. HCM This device will remain connected to battery.
3. PCM This device can remain connected to main plow plug.

Plow

If plow is Dismounted – Plug in power cable at Plow, Press Mount Switch until mounting is clamped completely. Go to **A**.

If plow is already mounted – Plug in power cable at Plow. Go to **A**.

If plow is already mounted and plugged in. Go to **A**.

NOTE: Mounting/dismounting is active for a 20 second period after power cable is plugged in. The headlights will flash at end of this 20 second period to indicate Mount/Dismount is ended. If Remote is powered ON while in mounting/dismounting, lights will flash immediately and system will go out of mounting/dismounting mode.

A. RCM

Plug the coiled power cord into the Meyer accessory port, then into the RCM.

To **Power On** the unit - Press and hold the green I/O button for 1 second.

(To **Power Off** the unit – Press and hold the green I/O button for 3 seconds.)

A screen will appear with the MEYER logo for approximately 3 seconds, after which an operational screen will appear. The operational screen will show:



The E-78 or E-88 icon on the left of the display indicates that the PCM is functional and communicating to the RCM. The icon on the right of the display indicates that the HCM is functional and communicating to the RCM. If the RCM should lose communication with the PCM or HCM for a certain length of time, this icon will disappear from the display.

The ALM function is only available when the PCM and HCM are recognized and found in the system by the RCM. When ALM is not available, the button labels for them will not be displayed. The WW button label represents the WigWag plow light function. If there isn't a plow in the system, WigWag is not available and the WW button label will not be displayed.

If the RCM does not display the PCM or HCM icon, check that the device's power connector is securely plugged in. When the device is powered on, the RCM will automatically detect it and put the appropriate icon and button labels on the display. The RCM searches for devices when it is powered on. Power cycling the RCM can be used to try to find the devices. There is a "FIND DEVICES" item in the Menu that will allow the RCM to search for devices.

The LED backlight turns on when the RCM is powered on. It will shut off after 30 seconds. It can be turned on again by pressing any button.

NOTE: If RCM is powered on during the Mounting/Dismounting sequence, the plow lights will flash and the plow will no longer mount/dismount.

"UP" Raise the moldboard by pressing the joystick control in the direction of the display.

"DOWN" Lower the moldboard by pressing the joystick control in the opposite direction of the display.

"FLOAT" If Down is held for .75 seconds, the unit will be placed in Float. While in Float, this icon will appear in the middle of the display:



"LEFT" Angle moldboard left by pressing joystick control to the left.

"RIGHT" Angle moldboard Right by pressing joystick control to the right.

SOFTKEY FEATURES:

ALM Press soft key above ALM to activate "Automatic Lower Mode", this mode will cause the moldboard to Lower (place in float) when the vehicle is placed in Reverse. Then it will raise the moldboard for 2 seconds when taken out of Reverse. (This action is only available if backup light wire is connected to the HCM)

ELECTRONIC TROUBLESHOOTING E-78 & E-88

SHK This option only available for 10 seconds after a “joy stick movement”(up, down, left, right). Press soft key below SHK to activate the “Shake” operation. This will cause the moldboard to shake back and forth for approximately 3 seconds to dislodge any snow on moldboard.

WW Press soft key below WW to activate “WigWag” lighting. Parking lights on plow lights will toggle on/off from side to side

Menu Press soft key below Menu to access other menu selectable actions:

(All Blade movement functions are disabled while in Menu screens)

DIAGNOSTICS: (Press **Sel**) This will display any faults that have been detected, Press **Next** to scroll through selections. Press **Exit** to leave.

FIND DEVICES: (Press **Sel**) This searches for external modules/devices such as HCM, PCM and will display those that are found. Press **Exit** to leave.

REMOTE SETTINGS: (Press **Sel**)

BUTTON CLICK: This feature Enables/Disables the button “beep”. Press **Exit** to leave.

DISPLAY CONTRAST: This feature increases or decreases the LCD contrast. Press **Exit** to leave.

VIEW SW VERSIONS: (Press **Sel**) This selects a device to display its software version number. On PCM and HCM “Internal Software Revision” refers to the software for the device that resides in the RCM. “External Software Revision” refers to the software that resides in the external device. Press **Exit** to leave.

PROGRAM DEVICES: (Press **Sel**) This feature allows field upgrades to the external device software. Select the device to program. If the software version of the external device is the same as the version of software for it stored in the RCM, programming will not be done. Follow instructions on screen. Press **Exit** to leave.

HEADLIGHTS:

Use the truck’s OEM light switch to control OFF/LO/HI beams.

At initial Power On – Plow lights will be set to Daytime Running Lights (DRL).

Move OEM switch to headlights ON – Plow lights will shine LO or HI depending on position of OEM switch.

Move OEM switch to headlights OFF – Plow lights go to DRL (GM vehicles may illuminate its DRL also)

TURN SIGNAL:

Plow lights will follow OEM switch – (vehicle signals will also illuminate but may not be synchronized with the plow lights)

PARK LIGHTS:

Plow lights will follow OEM switch – (vehicle park lights will also illuminate)

To **Turn Off** Plow lights: Power off the RCM.

NOTE: All lights, including interior and dash lights will dim while hydraulic unit is operating.

At RCM power off the plow lights will all be shut off and the lighting control will transfer back to the vehicle. If OEM headlight switch is ON at RCM power off, vehicle lights will shine. If OEM headlight switch is ON and PCM power is removed while RCM is still On, light control will transfer to vehicle.

MOUNT: There is a 20 second period after plugging in the Plow in which to operate the Mount switch. This Switch is located on the hydraulic unit cover. During this 20 second period, the moldboard functions are disabled. The moldboard functions are disabled for 15 seconds after the Mount switch is released. The pump motor will shut down if the Mount switch is held on for more than 30 seconds. If 20 seconds runs out unplug and replug to reset timer.

DISMOUNT: There is a 1 minute period after the RCM has been normally powered off in which to dismount the plow. The switch is located on the plow control cover. During this 1 minute period the blade functions are disabled. If the PCM remains powered on, after the 1 minute period the lights will flash twice quickly to indicate the dismount period has ended.

ELECTRONIC TROUBLESHOOTING E-78 & E-88

TIMEOUTS: The RCM will power off after 2 hours of inactivity. This conserves battery life if the unit is accidentally left on when driver leaves. This should provide ample time to transport between jobs or just to stop for lunch, etc. Simply pressing any button can reset this timer.

The Plow lights will remain powered on if there is a loss of communications. The moldboard functions will be disabled during this time. This can occur for a couple of different reasons:

1. If the Meyer accessory port plug is accidentally pulled out before the RCM is powered off normally.
2. If there is a real loss of communication between the PCM, HCM and RCM.

Overcurrent: The hydraulic unit will be shut down if an overcurrent situation occurs for more than 2 seconds. An alarm will sound and "Overcurrent" will appear on the display. This might happen when the blade is taken to full stops in any direction and held. "Stacking snow" is one reason this may occur. To reset, simply release the button and press again. If the fault occurs again the hydraulic unit will be shut down again.

Alarms/Faults: All faults will sound an alarm. To extinguish the alarm, press any button. To remove fault from the screen, press the **Exit** button to return to normal screen. The fault will remain in the diagnostic menu until it is cleared. All moldboard functions will remain active during the alarms, unless perhaps it is a bad solenoid. Example: A bad "B" solenoid, then the moldboard cannot be moved Up, but Left, Right, and Down are still available.

4. TROUBLESHOOTING DIAGRAMS

RCM will not power On

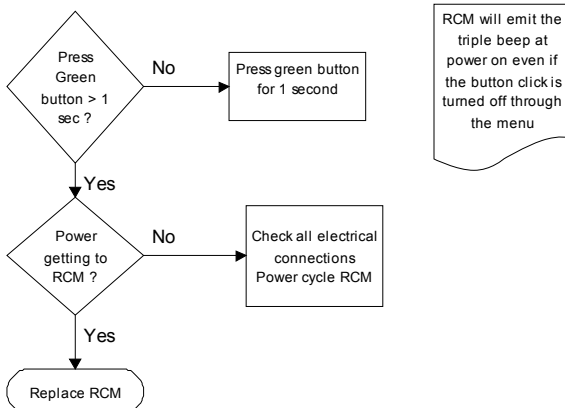

Plow Lights do not follow OEM switch positions (RCM and PCM are connected correctly and are working)

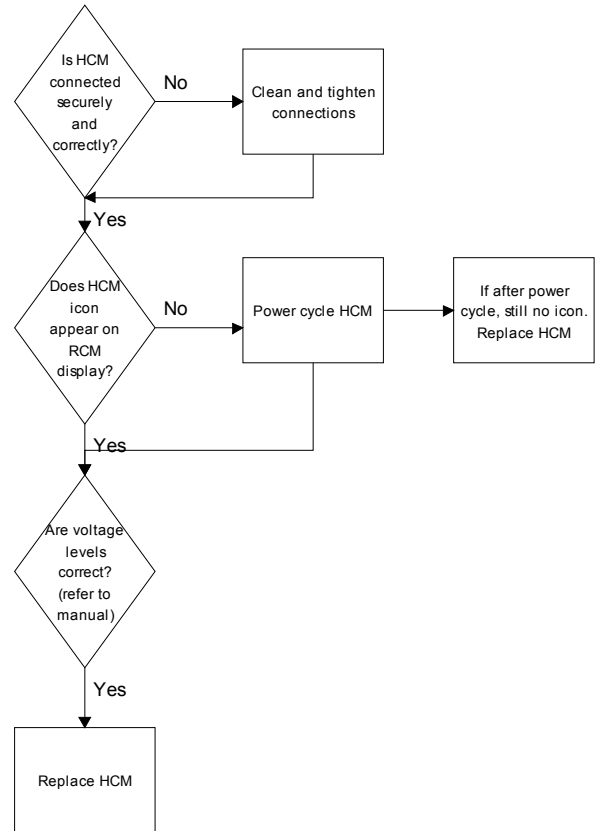

RCM Display shows Dark Lines, Updates slowly

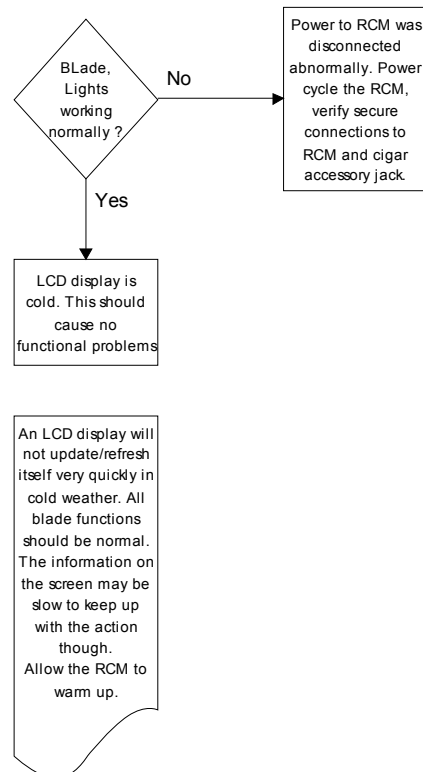

ELECTRONIC TROUBLESHOOTING E-78 & E-88

Vehicle lights do not work, no plow connected

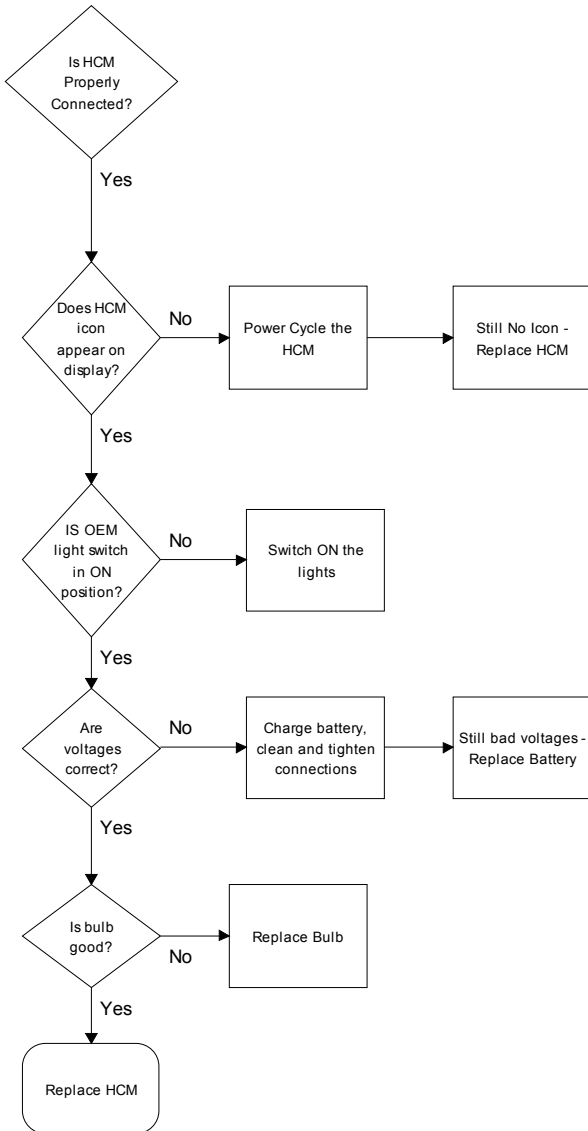

RCM Display appears Stuck on Meyer Logo

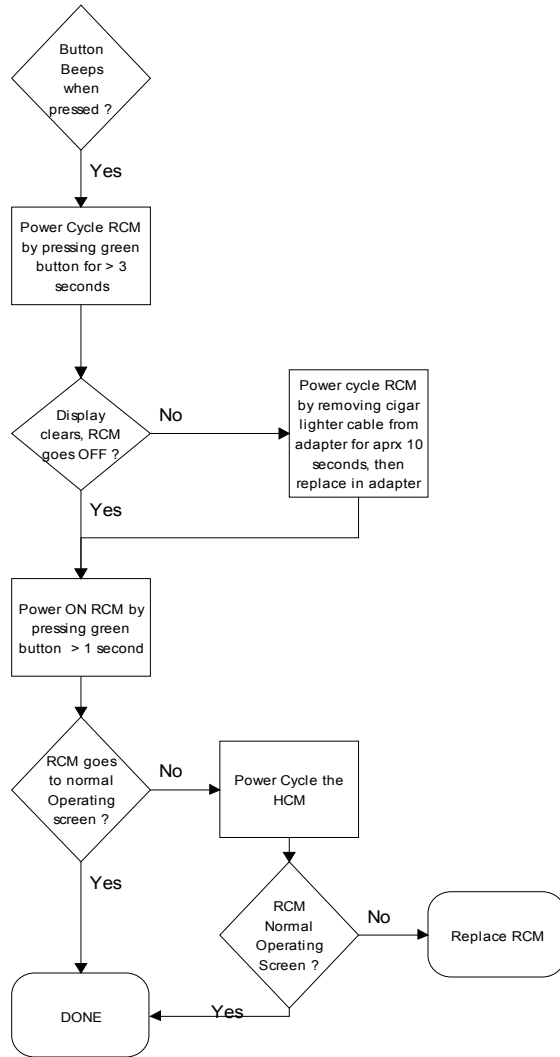

ELECTRONIC TROUBLESHOOTING E-78 & E-88

Moldboard will not move RCM, HCM are connected correctly

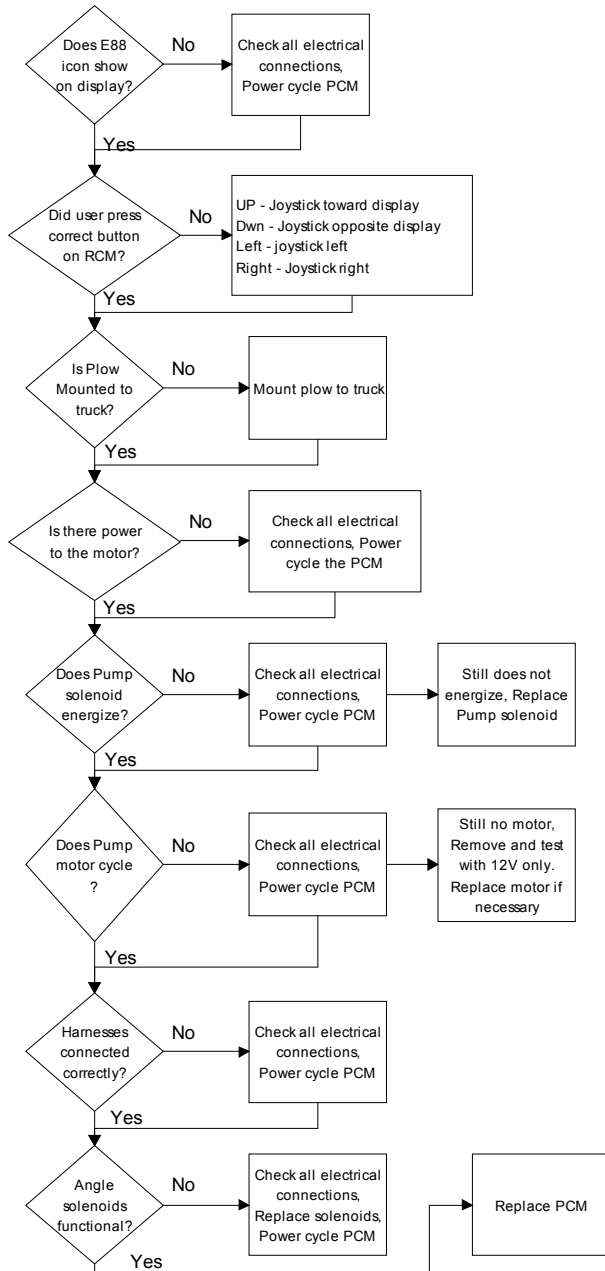

HYDRAULIC SPECIFICATIONS

ELECTRICAL SPECIFICATIONS

MOTOR

ISKRA AMJ4739 12V.

No load (motor not attached to pump)

NOTE: Do not operate motor continuously for more than 30 seconds.

Applied Voltage	12 Volts DC
Max. Current Draw	150 Amperes
Speed (Min.)	3,200 RPM

Under load (pump operating in relief)

NOTE: Do not operate motor continuously for more than 5 seconds.

Applied Voltage	12 Volts DC
Max. Current Draw	230 Amperes

SOLENOID VALVES "A", "B", "C", "D" and "E"

Applied Voltage	12 Volts DC
Current Draw	1.5 Amperes
Nominal resistance (ohm meter lead connected to coil lead)	8.0 ohms ± 10%.

MOTOR SOLENOID

Applied Voltage	12 Volts DC
Max. Current Draw	5 Amperes

Nominal resistance (ohm meter lead connected to coil lead, other meter lead connected to metal foot) 2.65 to 4.5 ohms.

HYDRAULIC SPECIFICATIONS

PUMP - Pressure Output

E-58H, E-78 & E-88 (Non Adjustable) 2000 P.S.I.

CROSSOVER RELIEF VALVE

Opening Pressure 3800 ± 400 P.S.I.

HYDRAULIC FLUID CAPACITY

NOTE :1 Quart = 32 Fluid Ounces

Model E-58H & E-78

Unit	1 qt., 4.5 oz. (36.5 oz.)
Hoses & 1-1/2 x 10 Cylinders	16 oz.
Total	1 qt., 20.5 oz. (52.5 oz.)

Model E-88

Unit	1 qt., 4.5 oz. (36.5 oz.)
Hoses & 1-1/2 x 10 Cylinders	16 oz.
Hoses & Mounting Cylinder	20 oz.
Total	2 qt., 8.5 oz. (72.5 oz.)

TORQUE SPECIFICATIONS

	<u>Thread Size</u>	<u>Torque (in.lbs.)</u>
Reservoir Cover		
Retaining Nuts	5/16-24	100-125
Pump Assembly		
Retaining Nuts/Bolts	5/16-24	100-125
End Plate or Valve Block		
Retaining Cap Screws	5/16-18	96-120
Motor to Pump Retaining		
Cap Screws	1/4-20	45-55
Drain and Filter Plugs	1/2-20	75-85



E-58H, E-68, E-78 & E-88 power unit service manual

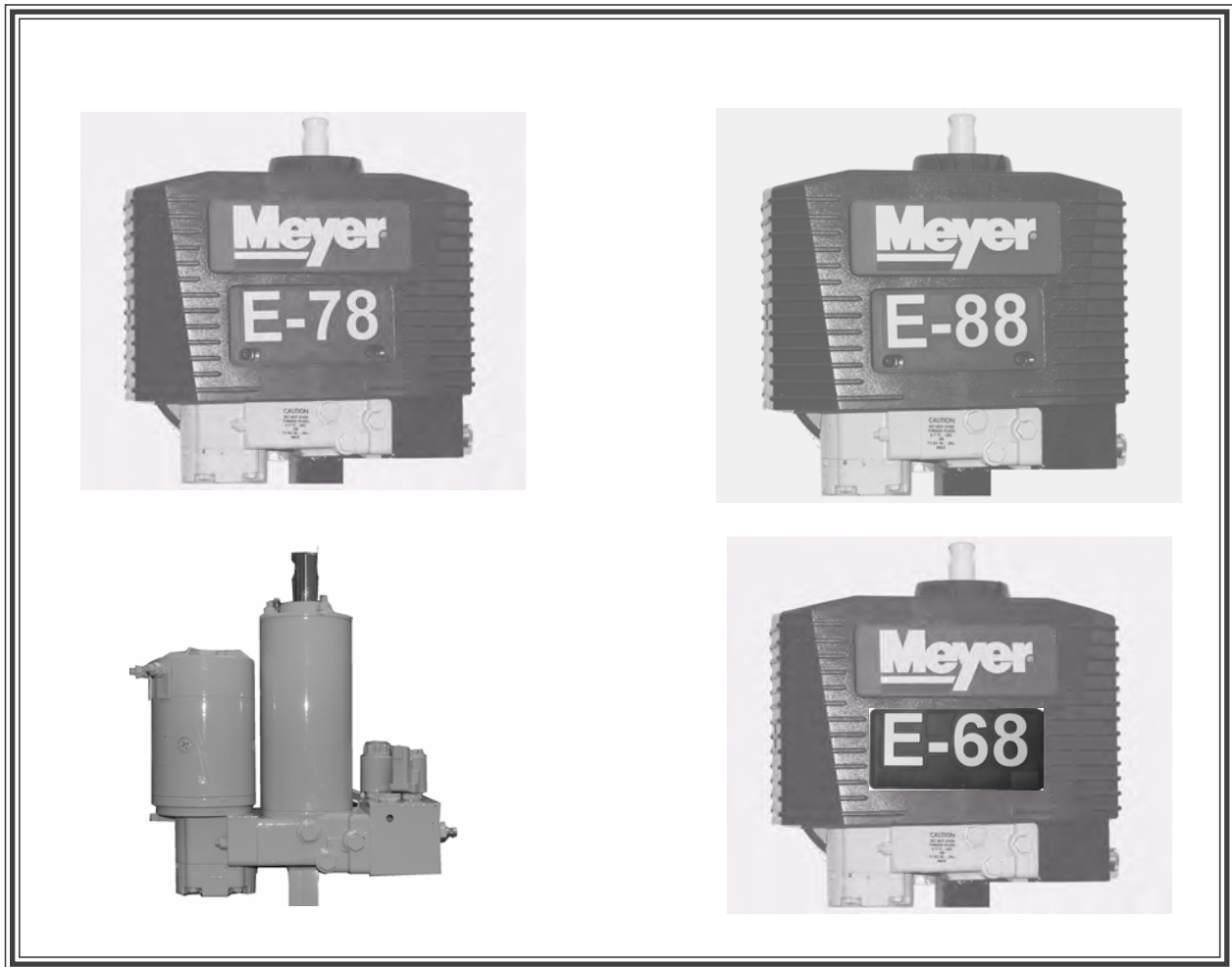

Meyer Products LLC
18513 Euclid Ave. • Cleveland, Ohio 44112-1084
Phone 486-1313 (Area Code 216)
www.meyerproducts.com • email info@meyerproducts.com

Meyer Products LLC
6 Angell Lane • Damariscotta, ME 04543-4507
Phone 563-2227 (Area Code 207)
www.meyerproducts.com • email info@meyerproducts.com

