





PARTS & INSTALLATION INSTRUCTIONS
MDII™ and EZ MOUNT PLUS™
SNOW PLOW MOUNTING 17139
1999 & Later GMC and CHEVROLET C/K SERIES
K1500 HD Non Commercial - Personal Use ONLY
K2500, K2500HD & K3500 SERIES 4x4 MODELS



End user must be given this instruction sheet prior to delivery of this Snow Plow.

SAFETY DEFINITIONS



	This is the safety alert symbol. It is used to alert you to potential personal injury hazards. Obey all safety messages that follow this symbol to avoid possible injury or death.
	DANGER Indicates an imminently hazardous situation which, if not avoided, will result in death or serious injury.
	WARNING Indicates a potentially hazardous situation which, if not avoided, could result in death or serious injury.
	CAUTION Indicates an potentially hazardous situation which, if not avoided, may result in minor or moderate injury.
	CAUTION used without the safety alert symbol indicates a potentially hazardous situation which, if not avoided, will result in property damage.

IMPORTANT NOTICE

In conjunction with FMVSS (Federal Motor Vehicle Safety Standards) and OEM (Original Equipment Manufacturer) guidelines, Meyer Products has designed this plow package with the following guidelines:

	Installation of a snowplow may effect your new vehicle warranty. For more information consult your Vehicle Owner's Manual / Vehicle Dealer.
	The vehicle must not be operated when overloaded. In all cases, the loaded vehicle weight, including the entire snowplow system, all aftermarket accessories, driver, passenger, options, nominal fluid levels, and cargo must not exceed the front/rear Gross Axle Weight Rating (GAWR), and total Gross Vehicle Weight Rating (GVWR). These weights ratings are specified on the safety compliance certification label on the driver's side door opening. The use of rear ballast weight may be required to prevent exceeding the front GAWR.

According to the NHTSA (National Highway Traffic Safety Administration) new and untitled vehicles need to be verified by the installer that snowplow and ballast (if needed) do no exceed the front/rear GAWR and total GVWR.

	 Read the Meyer Owner's Manual before operating or servicing a snowplow. FOLLOW THESE INSTRUCTIONS EXPLICITLY.
---	--

GENERAL INFORMATION

	SAFETY PRECAUTIONS should be used when Hydraulic Unit is in OPERATION and plow is in a RAISED position. Lower plow to ground when vehicle is PARKED in case of hydraulic failure.
---	---

Check contents against the parts list to determine all are correct and included, and also to familiarize yourself with them.

	Warranty does not apply to a Meyer or Diamond product which has been negligently or improperly assembled or installed.
---	--

	CAUTION: To avoid harm to vehicles electrical system always disconnect battery before beginning installation. DO NOT BURN holes or WELD vehicle frame. This may cause frame failure.
---	---

OVERHAUL and SERVICE INFORMATION are covered on separate instructions.

Meyer Products LLC reserves the right, under its continuing product improvement program, to change construction or design details, specifications and prices without notice or without incurring any obligation.

Meyer Products LLC
18513 Euclid Ave. • Cleveland, Ohio 44112-1084
Phone 486-1313 (Area Code 216)
www.meyerproducts.com • email info@meyerproducts.com



Meyer Products LLC
6 Angell Lane • Damariscotta, ME 04543-4507
Phone 563-2227 (Area Code 207)
www.meyerproducts.com • email info@meyerproducts.com

PARTS LIST



ITEM	PART NO.	QTY.	DESCRIPTION
	17139	1	MOUNTING CARTON
1	19225	1	• Underframe
2	19224	1	• R.H. Side Mount Weld
3	19223	1	• L.H. Side Mount Weld
	08735	1	• HARDWARE BAG
4	11636	2	•• Sleeve
5	20096	8	•• Bolt H 1/2-13 x 1-3/4" Gr. 5
6	20141	4	•• Bolt H 5/8-11 x 2" Gr.5
7	20152	3	•• Bolt H 5/8-11 x 5" Gr.5
8	22182	4	•• Bolt H M12 x 1.75 x 40mm Gr. 10.9
9	20307	8	•• Locknut Esna 1/2-13
10	20309	7	•• Locknut Esna 5/8-11
11	20355	4	•• Flatwasher 1/2"
12	20357	18	•• Flatwasher 5/8"
	21976	2	•• Battery Connector
	08406	1	•• 2007 Hardware Bag
13	20096	2	••• 1/2-13 x 1-3/4" Gr.5
14	19758	2	••• 1/2-13 Handle Nut
15	20355	2	••• Flatwasher 1/2"
*	19370	1	Universal Lift Frame (Part of Plus CLF Carton)
**	11770	1	Universal Lift Frame (Part of MDII CLF Carton)

IMPORTANT

After first use, retighten all mounting bolt connections to specified torque. All mounting bolt connections to be checked periodically for tightness.

Locknuts are furnished **DO NOT** tighten bolts and nuts until installation is complete (unless otherwise specified), then be sure to tighten all attaching parts per specified torque chart.

TORQUE CHART FOOT

Bolt Nut Size	Gr. 2 	Gr. 5 	Gr. 8 
1/4 - 20	4 - 5		
5/16 - 18	9 - 11		
3/8 - 16	17 - 20	26 - 29	
7/16 - 14		42 - 46	60 - 66
1/2 - 13		64 - 72	90 - 100
5/8 - 11		127 - 141	179 - 198

NOTE:

THIS MOUNTING CARTON CAN BE USED WITH THE MDII OR EZ MOUNT PLUS CLF CARTONS.

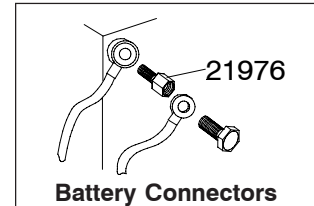

Meyer Products or Diamond Equipment assumes no responsibility for installations not made in accordance with these instructions.

SECTOR A-FRAME CARTONS

11" SECTOR				15" SECTOR	
MEYER					
K1500 HD		K2500		K2500 HD - K3500	
PART NO.	QTY.	PART NO.	QTY.	PART NO.	QTY.
16520	1	16515	1	16516	1
DIAMOND					
		81504	1	Common Attachment	
		81026	1	Push Frame	

Parts indented are included in the carton, bag or assembly under which they are indented.

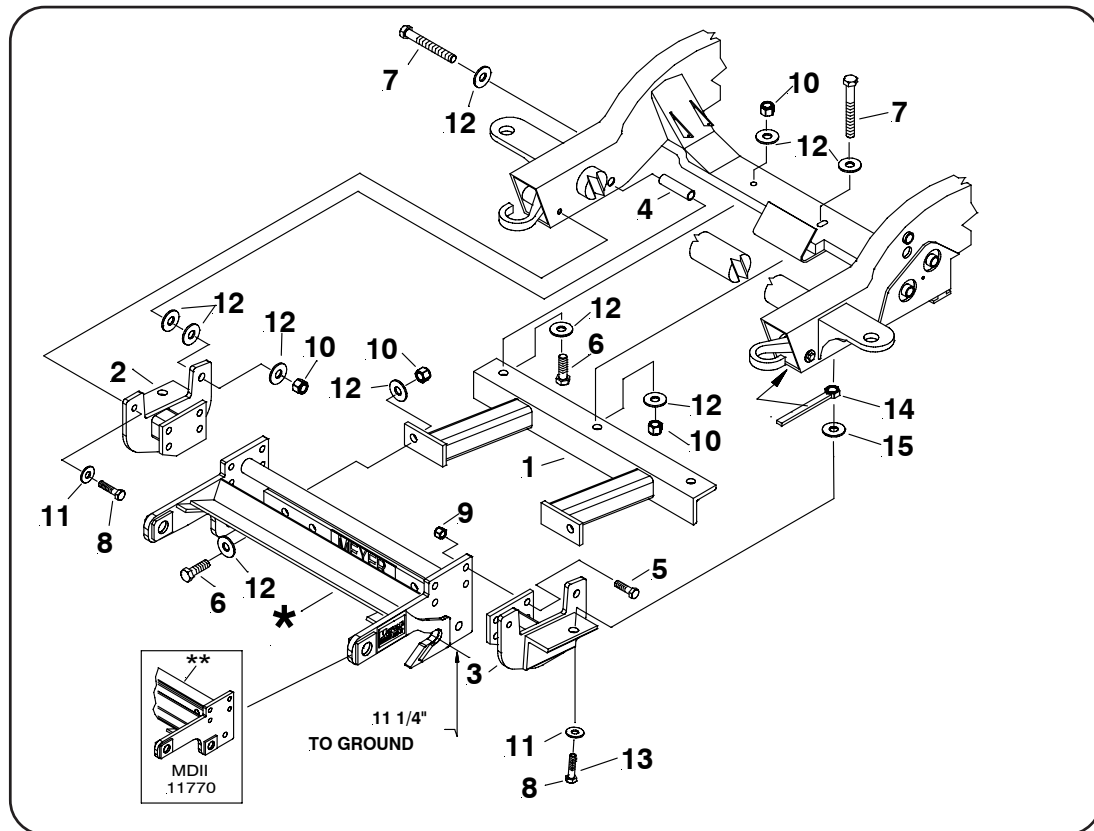

VEHICLE RECOMMENDATIONS

General Motors Corp.

General Motors recommends snowplow usage for only those trucks that have the option "VYU" Snow Plow Preparation Package.

2003

Model	G.V.W.	Opt.Code	Frnt. G.V.W.R.
-------	--------	----------	----------------

Regular/Extended Cab

	C 2500	7200 lb.	(C5Z)	4100 lb.
	C 2500	8600 lb.	(C6P)	4100 lb.
	K 2500	8600 lb.	(C6P)	4500 lb.
2003	All Models	9200 lb.	(C6W)	4800 lb.
	C/K 3500	8600 lb.	(C6P)	4500 lb.
2003	All Models	11400 lb.	(C7W)	4800 lb.

Cab Chassis Regular Cab only

	C 3500	8600 lb.	(C6P)	4100 lb.
	K 3500	8600 lb.	(C6P)	4500 lb.
2003	C/K 3600	12000 lb.	(C7L)	4800 lb.

Sport Utility Vehicles

	Model	G.V.W.	Opt.Code	Frnt. G.V.W.R.
2003	C2500	8600	(VYU)	4100 lb.
2003	K2500	8600	(VYU)	4500 lb.

General Motors recommends that when a snow plow is mounted that only one passenger should accompany the driver. More than one passenger may exceed front gross axle weight ratings.

▲WARNING

- Due to weight restrictions on vehicle's front GAWR, a STL-7.5 moldboard is the largest that can safely be installed on a K1500 HD

▲WARNING

- A ballast weight may be required to prevent front GAWR overloading. If required, ballast must be securely attached at least 24 inches rear of the rear axle.

▲WARNING

- Front end wheel alignment and headlight aim may require readjustment after installation of equipment, and is the responsibility of the equipment installer. Failure to adjust front wheel alignment may cause premature uneven tire wear. If required, reset to chassis manufacturer's specifications found in the GM Shop Manual.

Rear ballast is determined by weighing a vehicle's front and rear axles and adding weight behind the rear axle until front axle weight is under or equal to the vehicle specific front GAWR while not exceeding the rear GAWR and GVWR.

Vehicle option packages may vary. If in doubt, it is always a good idea to weigh the vehicle to ensure all weight ratings are not exceeded with plow in the raised position.

INSTALLATION INSTRUCTIONS

- Remove air dam. Retain all hardware. The air dam may be reinstalled.
 - Remove splash shield. It will not be reused. Hardware will not be reused.
 - Remove tow hook bolts from the bottom flange and inside of the frame rail on both driver and passenger sides. Retain hardware. They will not be reused. **On 2007 & Later models remove tow hooks and hardware entirely.**
 - Position LH & RH side mounts (2&3) on the inside of frame rails and align to where tow hook bolts were removed. Attach the side mounts using M12 x 1.75 x 40mm bolts (8), and 1/2" washers (11) into tow hooks. **Snug all bolts during the installation. Do not torque any bolts until step K.**
 - Using the rear holes in side mounts (2&3) as templates drill a 21/32" hole all the way through the frame on both sides. Remove side mounts and re-drill the insides of the frame ONLY with a 27/32" bit. This will allow for the installation of sleeve (4).
 - Loosely reattach the side mounts (2&3) using M12 x 1.75 x 40mm bolts (8), & 1/2" washers (11) on the inside of frame rails **ONLY**.
 - Loosely attach side mounts (2&3) at hole "A" using 5/8-11x5" bolts (7), sleeves (4), 5/8" washers (12), and 5/8-11 locknut (10), see illustration. Note: Two extra washers (12) per side have been provided to take up space between the vehicle frame and side mounts if needed.
 - Loosely reattach the RH side mount (2) the bottom of vehicle frame using a M12 x 1.75 x 40mm bolt (8) and 1/2" washer (11). Repeat for the LH side mount (3). **On 2007 & Later models use 1/2-13 x 1-3/4 Bolt (13), 1/2 Flatwashers (11 & 15) and 1/2-13 Handle Nut (14).**
 - Attach the Universal Clevis (*) between the LH & RH Side Mounts (2&3) using four 1/2-13 x 1-3/4" Bolts (5), and 1/2-13 Locknuts (9) on each side.
 - Position underframe (1) behind universal clevis' bottom angle. Using 5/8-11x2" bolts (6), 5/8" washers (12), and 5/8-11 locknuts (10), attach underframe to the back of the universal clevis and underneath the frame cross member per illustration. Using a 5/8-11x5" bolt (7), 5/8" flatwasher (12), and 5/8-11 locknut (10), finish attachment of underframe to vehicle crossmember per illustration (Note: Bolt (12) is installed from the top).
- Note: Before tightening the fasteners, the Clevis Frame (*) should be level with the ground and pushed back as far under the vehicle as possible.**
- Tighten all fasteners to their proper torque. Tighten bolts in the same order they were assembled to the vehicle.
 - Install remaining snowplow hardware per separate instructions.